



The HVP Lighting Collection

2024-2025



HVP Lighting werd opgericht in 1989 door Harry Van Parys. In de beginjaren was hij actief als verdeler van kerstattributen en kerstverlichting maar naargelang de vraag veranderde, evolueerde ook de firma door de jaren mee. Vandaag, 35 jaar later is HVP Lighting een technisch georiënteerd verlichtingsbedrijf met een specialisatie voor de projectmarkt.

Harry wordt inmiddels door een sterk gedreven team ondersteund. Het HVP-team heeft de missie om de ideale verlichting en zodoende de juiste sfeer voor iedere ruimte te creëren.

Iedere ruimte of kamer heeft zijn specifieke lichtnaden, HVP LIGHTING NV zorgt ervoor dat deze juist ingevuld worden, dit met de gepaste sfeer en voor een correcte prijs.

Wij bieden installateurs en architecten een Europees competitief gamma aan waarmee wij vooral actief zijn in de industriebouw, retail en de openbare sector (scholen, rusthuizen, parkings) en appartementsbouw.

HVP Lighting a été fondée en 1989 par Harry Van Parys. Dans les premières années, il était actif en tant que distributeur d'articles et d'éclairage de Noël, mais comme la demande a changé, l'entreprise a également évolué au fil des années. Aujourd'hui, 35 ans plus tard, HVP Lighting est une société d'éclairage à vocation technique avec une spécialisation pour le marché des projets.

Harry est désormais soutenu par une équipe solide. L'équipe HVP a pour mission de créer l'éclairage idéal, et donc l'atmosphère adéquate, pour chaque pièce.

Chaque espace ou pièce a des besoins d'éclairage spécifiques, HVP LIGHTING SA s'assure que ceux-ci soient correctement respectés, avec l'atmosphère appropriée, le tout pour un prix correct.

Nous proposons aux installateurs et architectes une gamme compétitive européenne avec laquelle nous sommes principalement actifs dans la construction industrielle, le retail et le secteur public (écoles, maisons de retraite, parkings).

CATEGORIE / CATÉGORIE

DOWNLIGHTS SPOTS INBOUW ENCASTRÉ	13
DOWNLIGHTS SPOTS OPBOUW APPARENT	99
RAILSYSTEMEN RAILSPOTS RAILS SPOTS SUR RAILS	135
OUTDOOR EXTERIEUR	225
INDUSTRIEEL ATEX INDUSTRIEL ATEX	295
NOODVERLICHTING ECLAIRAGE DE SECOURS	331

DOWNLIGHTS | SPOTS INBOUW | ENCASTRÉ

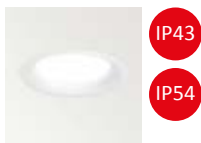

DROP
p. 14

IP43
IP54

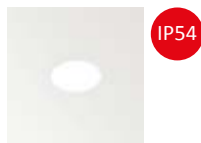

FOX
p. 18

IP54

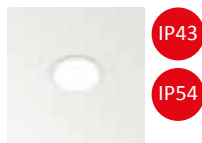

MIX
p. 20

IP43
IP54

NEW



BAZA
p. 22

IP44

NEW

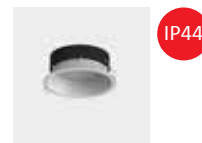

OCLA
p. 26

IP44



LEX
p. 28

IP20



DEEP
p. 32

IP43
IP54



BARI DL LED
p. 36

IP44

NEW

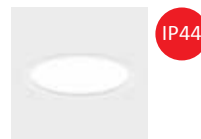

BARI Q LED
p. 40

IP44

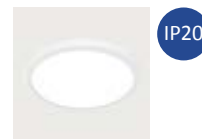

KAMELEON
p. 42

IP20



FLO fix
p. 46

IP20

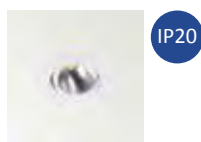

FLO move
p. 47

IP20



FLOX fix
p. 49

IP20



FLOX move
p. 50

IP20



MOVIMENTO
p. 51

IP20

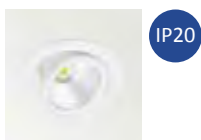

LEAN DL
p. 52

IP20

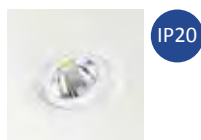

FIRST
p. 53

IP20

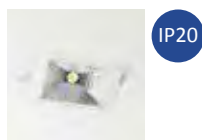

WALLY
p. 55

IP20



SWAP
p. 56

IP20
IP65

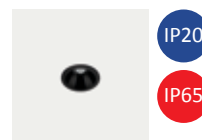

SHOT LIGHT
p. 60

IP20
IP65



BLACK FOSTER
p. 64

IP20

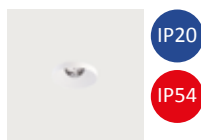

PUCK RECESSED
p. 68

IP20
IP54

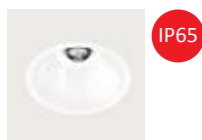

DUOMO
p. 70

IP65

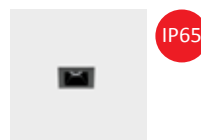

KURA
p. 72

IP65

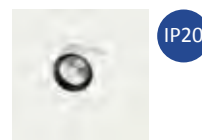

POP-UP
p. 74

IP20

NEW



NEO
p. 76

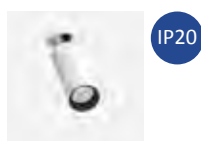

FIT RECESSED
p. 78

IP20



PLUS RECESSED
p. 80

IP20

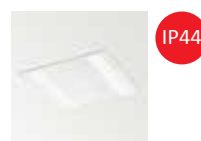

SUN LED
p. 82

IP44

NEW

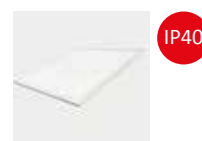

ELEMENT
p. 84

IP40



IP20

PARABOLIC LED
p. 86



IP20

PARABOLIC SLIM LED
p. 88

NEW



IP40

IP54

IP65

ROMA LED
p. 90

NEW



IP65

ROMA CLEAN IP65
p. 92



IP20

SPORT LED
p. 94



IP20

SQUARE LED
p. 96



IP20

SIMPLE ARC LED
p. 98

DOWNLIGHTS | SPOTS

OPBOUW | APPARENT



IP44
IP65

BARI ECO DLN LED
p. 100

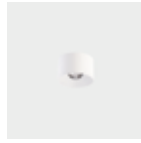

IP20

PUCK
p. 102



IP20

STRAM SURFACE
p. 106



IP20

TOP
p. 108

NEW



NEO ON
p. 110



IP20

BLACK FOSTER SURFACE
p. 114



IP20

CAJA
p. 118

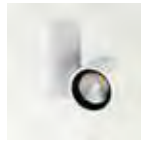

IP20

iO SURFACE
p. 120



IP20

FLOQ | FLOT
p. 122



IP20

FINESTRA RING LED
p. 126

NEW



IP20

FINESTRA Q LED
p. 128



IP44

FINESTRA IP44 LED
p. 130

NEW



IP65

SIENA
p. 132



IP54

SANI
p. 134



IP44

MIRROR LED
p. 136



IP54

LINEA
p. 138



IP54

SHINE
p. 140



IP66

NOA 50 | 100 TOP
p. 142

NEW



IP65

KURA TOP
p. 144



IP66

ART
p. 146



IP66

NOA WALL
p. 150

NEW



IP65

KURA REG X2
p. 152

NEW



IP66

TAPE
p. 154

NEW



IP66

FLAG
p. 156

NEW



IP66

AGO APPLIQUE
p. 158

NEW



IP66

TREND 60
p. 160

NEW

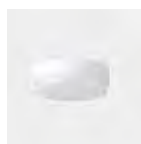

IP65

TRITON
p. 162

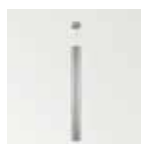

IP20

TUBO LED
p. 164

NEW



IP66

NEO BALL
p. 166

NEW



IP20

NEO AIR
p. 168

NEW



ISIS
p. 170

IP40

NEW



EGO LED EVO
p. 172

IP20



GEOMETRIC RING LED
p. 174

IP40

NEW



OVALO LED
p. 176

IP20

NEW



POKER Q LS LED
p. 178

IP20



GEOMETRIC ARC LED
p. 180

IP40



BEST CLEAN
p. 182

IP65



LINEA
p. 184

IP54

NEW



NAOS
p. 186

IP20



SPORT LED
p. 188

IP40



TORINO AS LED
p. 190

IP20

NEW



TORINO SPORT LED
p. 191

IP65

NEW



TORINO II IP65 LED
p. 192

IP65

RAILSYSTEMEN | RAILSPOTS

RAILS | SPOTS SUR RAILS

NEW



ARCANO
p. 194



HUB LED
p. 205

IP20

NEW



STIO
p. 206



TRIGGER CAFETERIA
p. 207

IP20



SINTRA
p. 208

IP20

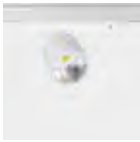

CASA
p. 209

IP20



GA-016 LEAN
p. 210

IP20

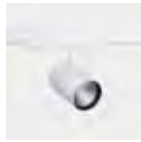

GA-016 DINGO
p. 211

IP20



GA-016 BING
p. 212

IP20

NEW



GLIDER TREND
p. 213

IP20

NEW



ARDEA
p. 214

IP20

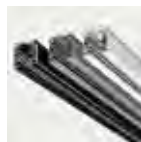

GLOBAL TRAC PULSE
p. 216

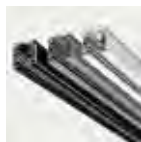

GLOBAL TRAC PRO
p. 219

OUTDOOR EXTERIEUR



IP66

TAG 110 | TAG 210
p. 226

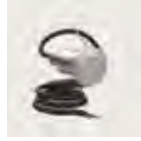

IP67

CNC
p. 232

NEW

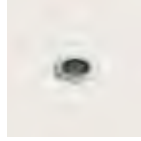

IP67

INC 35 | INC 50
p. 240



IP66

KOI 110 POST
p. 242



IP66

KIT LINE POST
p. 244



IP66

LINE 330
p. 248



IP66

GREEN LIGHT LED
p. 250



IP66

TOK
p. 252



IP66

TREND 60 POST
p. 256

NEW



IP66

FLAG
p. 258

NEW



IP66

AGO BOLLARD
p. 262



IP66

AGO GARDEN
p. 264

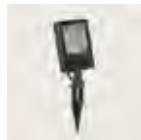

IP66

KIT TAG GARDEN
p. 268



IP66

ANTARES
p. 270



IP66

PIXEL
p. 272



IP66

JOY 2.0
p. 274



IP66

REPLAY
p. 276



IP66

SKYLINE
p. 278



IP66

SOUL LED
p. 280



IP67

ILUMO LED
p. 282

NEW



IP66

APOLLO
p. 284



IP66

MATCH
p. 286















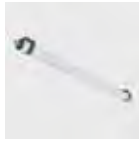

NEW



IP66

GEMINI PRO
p. 288

INDUSTRIEEL | ATEX INDUSTRIEL | ATEX

<p>NEW</p>  <p>IP66 IP69</p> <p>NANOTTICA p. 292</p>	<p>NEW</p>  <p>IP66</p> <p>FUTURA p. 296</p>	<p>NEW</p>  <p>IP66 IP69</p> <p>INNOVA p. 299</p>	<p>NEW</p>  <p>IP66</p> <p>AQUA 40 LED p. 302</p>	<p>NEW</p>  <p>IP66 IP68 IP69</p> <p>AQUA 70 LED p. 304</p>
<p>NEW</p>  <p>IP65</p> <p>BOXER p. 306</p>	<p>NEW</p>  <p>IP65</p> <p>STAFORD LED p. 308</p>	<p>NEW</p>  <p>IP66</p> <p>FROST PLUS p. 310</p>	<p>NEW</p>  <p>IP20 IP44</p> <p>TRUNKING p. 312</p>	<p>NEW</p>  <p>IP66</p> <p>PRIMA LED EX p. 314</p>
<p>NEW</p>  <p>IP66</p> <p>TREX p. 316</p>	<p>NEW</p>  <p>IP66 IP68</p> <p>AQUA 70 EX LED p. 318</p>	<p>NEW</p>  <p>IP65</p> <p>PITBUL N LED p. 320</p>	<p>NEW</p>  <p>IP66</p> <p>BASET N LED p. 322</p>	<p>NEW</p>  <p>IP68-2</p> <p>SECURE LED p. 324</p>
<p>NEW</p>  <p>IP66</p> <p>HYPER PRO p. 326</p>	<p>NEW</p>  <p>IP65</p> <p>CANNON II p. 328</p>			

NOODVERLICHTING

ECLAIRAGE DE SECOURS



IP20

ONTEC C - D
p. 332



IP65

ONTEC S
p. 334

NEW



IP65

ONTEC S30
p. 336



IP20

ONTEC G
p. 338



IP20

ONTEC E
p. 340



IP20

ONTEC R
p. 342



DATA 2
p. 344

De vermelde prijzen zijn indicatieve brutoprijzen zonder mogelijke opties of meerprijzen.
Deze zijn bedoeld om een vlugge budgettering te kunnen maken of te kunnen inschatten in welke prijsrichting het artikel zich bevindt.
Voor een nauwkeurige prijsofferte/ev. lichtstudie staat ons team ter uwer beschikking.

Les prix indiqués sont des prix bruts indicatifs sans les options possibles ou suppléments de prix.
Le but étant de pouvoir faire une budgétisation rapide ou d'estimer dans quelle échelle de prix l'article se situe.
Notre équipe est à votre disposition pour une offre de prix précise ou une éventuelle étude d'éclairage.

DOWNLIGHTS | SPOTS
INBOUW | ENCASTRÉ



1 DROP

DROP LED is een architecturale downlight uit aluminium. Het toestel creëert een zacht overvloeiend effect wanneer deze geïnstalleerd is. De rand van het toestel wordt weggewerkt door de diepere ligging van de LED's. De **DROP LED** bestaat in diverse groottes, lumenoutputs en IP-waardes.

Le **DROP LED** est un downlight architectural en aluminium. Lorsque celui-ci est installé, il produit un doux effet qui, grâce à sa clarté débordante, efface la limite de la source lumineuse. L'effet d'éclairage de ce plafonnier est semblable à celle d'une lucarne naturelle. Le **DROP LED** existe en différentes grandeurs, puissances, et valeurs IP.

DROP

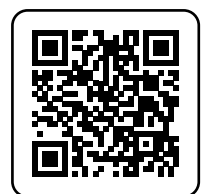



DROP

ALGEMEEN / GÉNÉRALITÉS

TYPE inbouw muur, plafond / encastrément mur, plafond

MATERIAL aluminium

OPTION dimming: push | 1-10V | DALI

DROP MAXI

KENMERKEN / CARACTÉRISTIQUES

W	CT	Lm	COLOUR	€ PRICE
15W	3000K 4000K	2450 2500	☐	362
22W	3000K 4000K	3450 3500	☐	378
31W	3000K 4000K	4700 4775	☐	392
40W	3000K 4000K	5825 5925	☐	420



L80B10
>60.000h

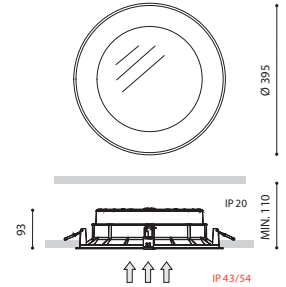

DROP

KENMERKEN / CARACTÉRISTIQUES

W	CT	Lm	COLOUR	€ PRICE
10,5W	2700K 3000K 4000K	1525 1650 1675	☐	201
15,5W	2700K 3000K 4000K	2100 2275 2300	☐	209
22W	2700K 3000K 4000K	2800 3025 3075	☐	218
27W	3000K 4000K	4050 4100	☐	263



L80B10
>60.000h

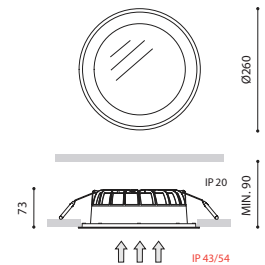



DROP MINI

W	CT	Lm	COLOUR	€ PRICE
7W	2700K 3000K 4000K	975 1050 1075	□	132
10W	2700K 3000K 4000K	1275 1375 1400	□	141



L80B10
>60.000h

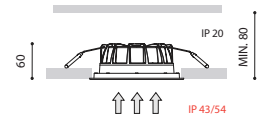

DROP MICRO

ALGEMEEN / GÉNÉRALITÉS

OPTION dimming: Phase cut

KENMERKEN / CARACTÉRISTIQUES

W	CT	Lm	COLOUR	€ PRICE
5W	2700K 3000K 4000K	700 730 750	□ ■	89
7,5W	2700K 3000K 4000K	950 1000 1030	□ ■	101



L80B10
>60.000h

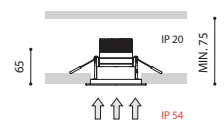





2 FOX

De **FOX LED** en **FOX LED MINI** zijn ultradunne downlights gemaakt uit polycarbonaat. Door de dunne rand van slechts enkele millimeters lijkt het alsof de **FOX LED** trimless is ingebouwd. Deze is ideaal voor vochtige ruimtes. Dit toestel is perfect geschikt om dicht bij de zee te installeren.

Le **FOX LED** et **FOX LED MINI** sont des downlights ultra-fin en polycarbonate. La finesse de sa collerette de seulement quelques millimètres lui donne presque un « effet trimless ». Étanche à l'eau, résistant aux chocs et à la corrosion : il convient également pour être installé dans des endroits proche de la mer.



FOX





FOX

ALGEMEEN / GÉNÉRALITÉS

TYPE inbouw muur, plafond / encastrément mur, plafond

MATERIAL polycarbonate | polycarbonate-matt

OPTION dimming: push | DALI

KENMERKEN / CARACTÉRISTIQUES

W	K	Lm	COLOUR	€ PRICE
10,5W	2700K 3000K 4000K	1500 1625 1650	☐	92
15,5W	2700K 3000K 4000K	2050 2225 2250	☐	96



L80B10
>60.000h

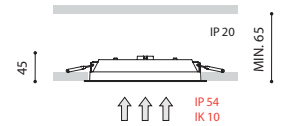

FOX MINI

KENMERKEN / CARACTÉRISTIQUES

W	K	Lm	COLOUR	€ PRICE
7W	2700 K 3000K 4000K	925 1000 1025	☐	70
10W	2700 K 3000K 4000K	1200 1300 1325	☐	75



L80B10
>60.000h

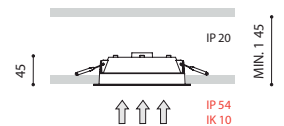



3 MIX

De **MIX LED** en **MIX LED MINI** zijn de standaard downlights binnen ons gamma. Deze zijn vergelijkbaar met de FOX LED maar vervaardigd uit aluminium waardoor het toestel zwaardere wattages aankan. De MIX LED is verkrijgbaar in verschillende groottes, lumenoutputs en IP-waardes.

Le **MIX LED** et le **MIX LED MINI** sont les downlights standards de notre gamme. Comparable au FOX LED mais conçu en aluminium. Grâce à cela il supporte des puissances plus importantes. Il reprend toutes les qualités de nos meilleurs produits et propose un large éventail d'options : dimensions, lumens, valeurs IP,...



MIX

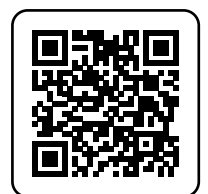



MIX

ALGEMEEN / GÉNÉRALITÉS

TYPE inbouw muur, plafond / encastrément mur, plafond

MATERIAL aluminium / polymethyl methacrylate

OPTION dimming: push | DALI

KENMERKEN / CARACTÉRISTIQUES

W	CT	Lm	COLOUR	€ PRICE
10,5W	2700K 3000K 4000K	1525 1650 1675	☐	105
15,5W	2700K 3000K 4000K	2100 2275 2300	☐	110
22W	2700K 3000K 4000K	2800 3025 3075	☐	116
27W	3000K 4000K	4050 4100	☐	154



option

option

102°

Ø 205

option

L80B10
>60.000h



Ø222

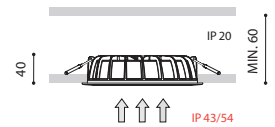

MIX MINI

KENMERKEN / CARACTÉRISTIQUES

W	CT	Lm	COLOUR	€ PRICE
7W	2700K 3000K 4000K	975 1050 1075	☐	87
10W	2700K 3000K 4000K	1275 1375 1400	☐	92



option

option

97°

Ø122

option

L80B10
>60.000h



Ø136

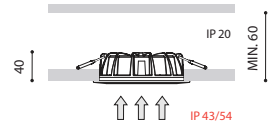



4 BAZA

NEW

De **BAZA** is een technische downlight met meerdere mogelijkheden naar vermogen, diameter, reflector en wattages. Daarnaast zijn er ook vergrotringen beschikbaar specifiek voor relighting

Le **BAZA** est un downlight offrant de multiples options en termes de puissances, diamètres et réflecteurs. De plus, des collerettes spéciales relighting sont également disponibles.

BAZA





BAZA

ALGEMEEN / GÉNÉRALITÉS

TYPE	inbouw plafond / encastrément plafond
MATERIAL	aluminium
CT	3000K 4000K
OPTION	dimming: DALI witte reflector / reflecteur blanc hoogglans reflector / réflecteur

Ø 110 mm

KENMERKEN / CARACTÉRISTIQUES

W	CT	Lm	DRIVER	COLOUR	€ PRICE
8,5W	3000K	735	200mA	<input type="checkbox"/>	103
8,7W	4000K	766	200mA	<input type="checkbox"/>	103
13,6W	3000K	1189	350mA	<input type="checkbox"/>	103
14,1W	4000K	1232	350mA	<input type="checkbox"/>	103
20,3W	3000K	1620	500mA	<input type="checkbox"/>	103
20,7W	4000K	1668	500mA	<input type="checkbox"/>	103

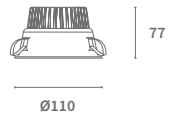

Ø 140 mm

KENMERKEN / CARACTÉRISTIQUES

W	CT	Lm	DRIVER	COLOUR	€ PRICE
9W	3000K	921	225mA	<input type="checkbox"/>	130
8,9W	4000K	991	225mA	<input type="checkbox"/>	130
12,4W	3000K	1387	350mA	<input type="checkbox"/>	130
12,3W	4000K	1488	350mA	<input type="checkbox"/>	130
18,2W	3000K	1988	500mA	<input type="checkbox"/>	130
18W	4000K	2128	500mA	<input type="checkbox"/>	130
21,1W	3000K	2281	600mA	<input type="checkbox"/>	130
20,8W	4000K	2452	600mA	<input type="checkbox"/>	130

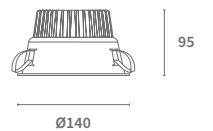



Ø 165 mm

KENMERKEN / CARACTÉRISTIQUES

W	CT	Lm	DRIVER	COLOUR	€ PRICE
9,1W	3000K	988Lm	225mA	☐	157
9,1W	4000K	994Lm	225mA	☐	157
12,7W	3000K	1433Lm	350mA	☐	157
13,2W	4000K	1441Lm	350mA	☐	157
18,3W	3000K	2007Lm	500mA	☐	157
19,2W	4000K	2048Lm	500mA	☐	157
21,5W	3000K	2319Lm	600mA	☐	157
22,3W	4000K	2348Lm	600mA	☐	157
26,2W	3000K	2747Lm	700mA	☐	157
27,3W	4000K	2781Lm	700mA	☐	157
30,4W	3000K	3106Lm	800mA	☐	157
31W	4000K	3136Lm	800mA	☐	157

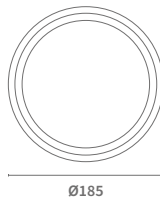
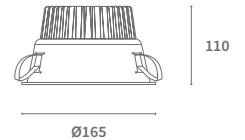

ACCESSOIRES

Vergrootring / Anneau de recouvrement 185 mm



Ø 190 mm

KENMERKEN / CARACTÉRISTIQUES

W	CT	Lm	DRIVER	COLOUR	€ PRICE
9,1W	3000K	988Lm	225mA	☐	173
9,4W	4000K	1034Lm	225mA	☐	Ø185
12,8W	3000K	1424Lm	350mA	☐	173
13,1W	4000K	1482Lm	350mA	☐	173
18,7W	3000K	2024Lm	500mA	☐	173
19,2W	4000K	2177Lm	500mA	☐	173
21,5W	3000K	2304Lm	600mA	☐	173
22,5W	4000K	2442Lm	600mA	☐	173
26,4W	3000K	2735Lm	700mA	☐	173
27,6W	4000K	2889Lm	700mA	☐	173
30,3W	3000K	3106Lm	800mA	☐	173
31,6W	4000K	3251Lm	800mA	☐	173

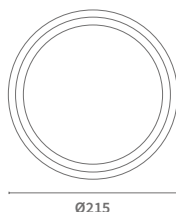
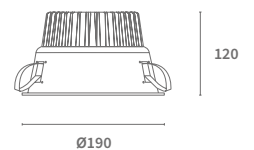

ACCESSOIRES

Vergrootring / Anneau de recouvrement 215 mm



Ø 230 mm

KENMERKEN / CARACTÉRISTIQUES

W	CT	Lm	DRIVER	COLOUR	€ PRICE
12,6W	3000K	1508Lm	350mA	☐	187
13,1W	4000K	1542Lm	350mA	☐	187
18,5W	3000K	2139Lm	500mA	☐	187
19,1W	4000K	2175Lm	500mA	☐	187
21,6W	3000K	2461Lm	600mA	☐	187
22,4W	4000K	2509Lm	600mA	☐	187
26,2W	3000K	2916Lm	700mA	☐	187
27,3W	4000K	2976Lm	700mA	☐	187
30,5W	3000K	3322Lm	800mA	☐	187
31,3W	4000K	3497Lm	800mA	☐	187

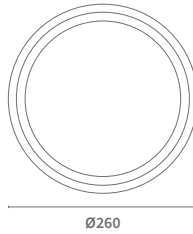
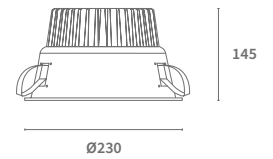

ACCESSOIRES

Vergrootring / Anneau de recouvrement 260 mm

Noodunit / Unité de secours





5 OCLA

De **OCLA** is een standaard downlight met gunstige prijs-kwaliteitverhouding verkrijgbaar in drie maten met verschillende reflectormogelijkheden.

L' **OCLA** est un downlight standard avec un rapport qualité-prix avantageux, disponible en trois tailles avec différents réflecteurs.

NEW

OCLA



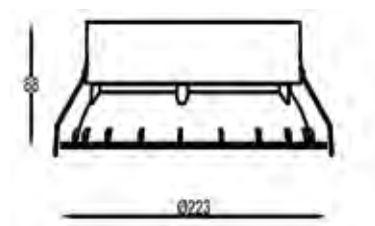
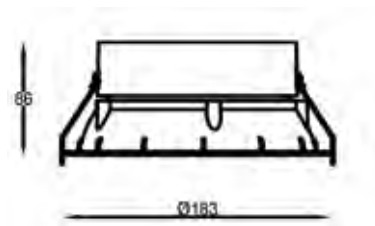
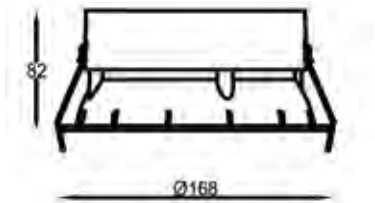
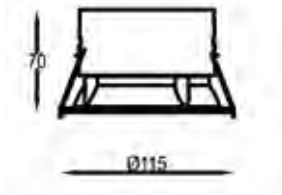

OCLA

ALGEMEEN / GÉNÉRALITÉS

TYPE inbouw plafond / encastrément plafond

MATERIAL aluminium

OPTION dimming: DALI | Casambi
witte reflector / réflecteur blanc | hoogglans reflector / réflecteur brillant

Ø 115 mm

KENMERKEN / CARACTÉRISTIQUES

W	CT	Lm	DRIVER	COLOUR	€ PRICE
8,7W	3000K 4000K	782 815	200mA	□	96
13,3W	3000K 4000K	1265 1310	350mA	□	96



Ø 168 mm

KENMERKEN / CARACTÉRISTIQUES

W	CT	Lm	DRIVER	COLOUR	€ PRICE
13,3W	3000K 4000K	1518 1540	350mA	□	124
18,3W	3000K 4000K	2127 2170	500mA	□	124
21,5W	3000K 4000K	2458 2488	600mA	□	124



Ø 183 mm

KENMERKEN / CARACTÉRISTIQUES

W	CT	Lm	DRIVER	COLOUR	€ PRICE
13,3W	3000K 4000K	1552 1615	350mA	■ □	129
18,3W	3000K 4000K	2207 2498	500mA	■ □	129
21,5W	3000K 4000K	2498 2117	600mA	■ □	129



Ø 223 mm

KENMERKEN / CARACTÉRISTIQUES

W	CT	Lm	DRIVER	COLOUR	€ PRICE
13,3W	3000K 4000K	1658 1696	350mA	■ □	139
18,3W	3000K 4000K	2477 2392	500mA	■ □	139
21,5W	3000K 4000K	2707 2759	600mA	■ □	139
26,5W	3000K 4000K	3207 3273	700mA	■ □	139





6 LEX

LEX ECO is een ideaal toestel voor algemene verlichting met een diepliggende lamp en opvallend lage UGR-waarden (12,4-14,9).

OPTIE: **LEX ECO BLUE**: blauw sfeerlicht in de rand die een accent geeft wanneer het toestel gedoofd is.

LEX ECO est l'appareil idéal pour l'éclairage général avec une source lumineuse en retrait et des valeurs UGR remarquablement basses (12,4-14,9).

OPTION : **LEX ECO BLUE** : lumière d'ambiance bleutée au niveau du rebord, celle-ci donne un accent particulier lorsque l'appareil est éteint.

LEX ECO





LEX

ALGEMEEN / GÉNÉRALITÉS

TYPE inbouw muur, plafond / encastrément mur, plafond

MATERIAL aluminium | polycarbonate

OPTION dimming: push | DALI

KENMERKEN / CARACTÉRISTIQUES

W	K	Lm	COLOUR	€ PRICE
10W	2700K 3000K 4000K	1370 1420 1440		147
17W	2700K 3000K 4000K	2070 2150 2180		158
24W	2700K 3000K 4000K	2690 2800 2840		174



L80B10
>60.000h

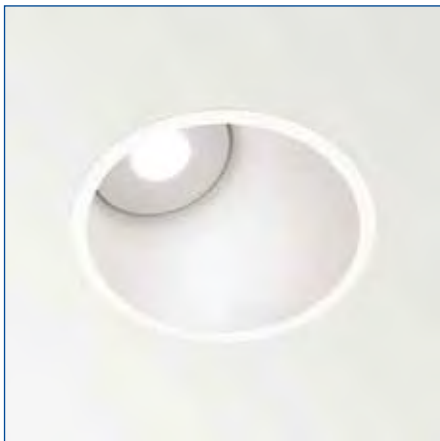
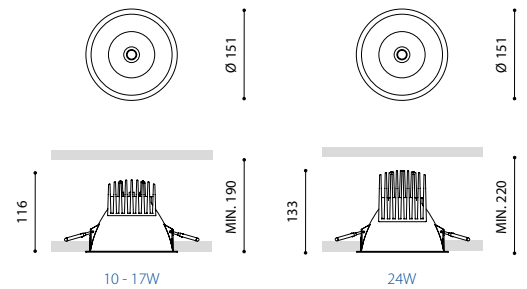

LEX ASYMMETRIC

ALGEMEEN / GÉNÉRALITÉS

TYPE inbouw muur, plafond / encastrément mur, plafond

MATERIAL aluminium | polycarbonate

OPTION dimming: push | DALI

KENMERKEN / CARACTÉRISTIQUES

W	CT	Lm	COLOUR	€ PRICE
10W	2700K 3000K 4000K	1370 1420 1440		153
17W	2700K 3000K 4000K	2070 2150 2180		162
24W	2700K 3000K 4000K	2690 2800 2840		180



L80B10
>60.000h

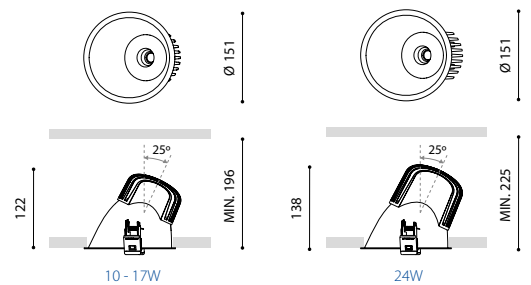



LEX MINI

ALGEMEEN / GÉNÉRALITÉS

TYPE inbouw muur, plafond / encastrément mur, plafond

MATERIAL aluminium | polycarbonate

OPTION dimming: push | DALI

KENMERKEN / CARACTÉRISTIQUES

W	CT	Lm	COLOUR	€ PRICE
6,5W	2700K 3000K 4000K	910 940 960	<input type="checkbox"/> <input type="checkbox"/> <input type="checkbox"/> <input type="checkbox"/> <input type="checkbox"/> <input type="checkbox"/>	125
12W	2700K 3000K 4000K	1400 1460 1480	<input type="checkbox"/> <input type="checkbox"/> <input type="checkbox"/> <input type="checkbox"/> <input type="checkbox"/> <input type="checkbox"/>	137



L80B10
>60.000h

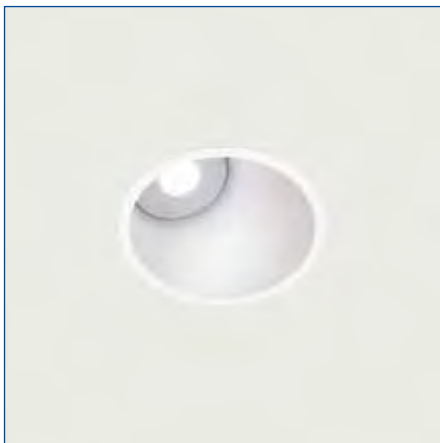
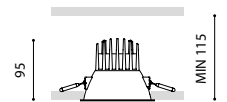

LEX MINI ASYMMETRIC

ALGEMEEN / GÉNÉRALITÉS

TYPE inbouw muur, plafond / encastrément mur, plafond

MATERIAL aluminium | polycarbonate

OPTION dimming: push | DALI

KENMERKEN / CARACTÉRISTIQUES

W	CT	Lm	COLOUR	€ PRICE
6,5W	2700K 3000K 4000K	910 940 960	<input type="checkbox"/> <input type="checkbox"/> <input type="checkbox"/> <input type="checkbox"/> <input type="checkbox"/> <input type="checkbox"/>	128
12W	2700K 3000K 4000K	1400 1460 1480	<input type="checkbox"/> <input type="checkbox"/> <input type="checkbox"/> <input type="checkbox"/> <input type="checkbox"/> <input type="checkbox"/>	140



L80B10
>60.000h

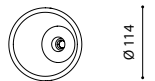





7 DEEP

De **DEEP** maakt deel uit van een breed ontwikkeld gamma van downlights met technisch erg correcte waarden, geschikt voor algemene verlichting van bijvoorbeeld bureaus, residentiële toepassingen en retail.

Le **DEEP** provient d'une large gamme de downlights avec des valeurs techniques très correctes, adapté à l'éclairage général des bureaux, applications résidentielles et vente au détail.



DEEP





DEEP

ALGEMEEN / GÉNÉRALITÉS

TYPE inbouw muur, plafond / encastrément mur, plafond

MATERIAL aluminium | polymethyl methacrylate

OPTION dimming: push | 1-10V | DALI

DEEP MAXI

KENMERKEN / CARACTÉRISTIQUES

W	CT	Lm	COLOUR	€ PRICE
15W	3000K 4000K	2450 2500	☐	350
22W	3000K 4000K	3450 3500	☐	363
31W	3000K 4000K	4700 4775	☐	375
40W	3000K 4000K	5825 5925	☐	404



L80B10
>60.000h

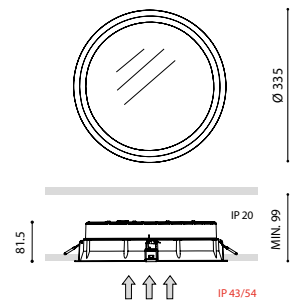

DEEP

KENMERKEN / CARACTÉRISTIQUES

W	CT	Lm	COLOUR	€ PRICE
10,5W	2700K 3000K 4000K	1525 1650 1675	☐	177
15,5W	2700K 3000K 4000K	2100 2275 2300	☐	183
22W	2700K 3000K 4000K	2800 3025 3075	☐	192
27W	3000K 4000K	4050 4100	☐	261



L80B10
>60.000h

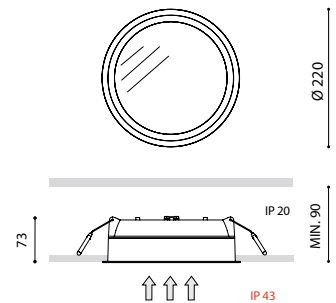





DEEP MINI

KENMERKEN / CARACTÉRISTIQUES

W	CT	Lm	COLOUR	€ PRICE
7W	2700K 3000K 4000K	975 1050 1075	□	123
10W	2700K 3000K 4000K	1275 1375 1400	□	129



L80B10
>60,000h

option

option

89°

Ø 122

option

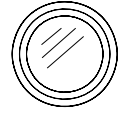

Ø 135

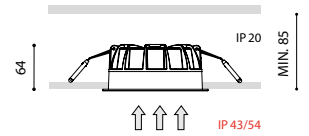

IP 43/54





8 BARI DL LED

De **BARI DL LED** is een moderne en universele downlight met sterke technische eigenschappen. Toepassing: kantoren, hotels, restaurants, zalen, winkelcentra,...

Le **BARI DL LED** est un downlight moderne et universel avec des caractéristiques techniques élevées. Applications : bureaux, restaurants, hôtels, couloirs, galeries, etc.

BARI DL





BARI MINI DL LED

ALGEMEEN / GÉNÉRALITÉS

TYPE inbouw muur, plafond / encastrément mur, plafond

MATERIAL aluminium

OPTION dimming: DALI

KENMERKEN / CARACTÉRISTIQUES

Ø	W	CT	Lm	A	COLOUR	€ PRICE
120	13W	3000K 4000K	1400 1470	20° 30° 50°	□	97



L90B10
>56.000h

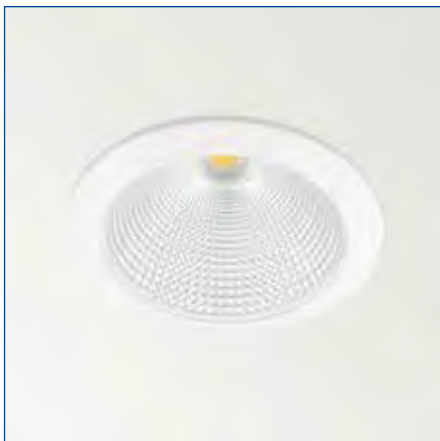
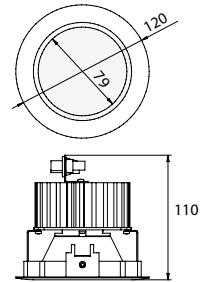

BARI DL LED

KENMERKEN / CARACTÉRISTIQUES

Ø	W	CT	Lm	A	COLOUR	€ PRICE
155	15W	3000K 4000K	1670 1720	45°	□	119
155	21W	3000K 4000K	2300 2370	45°	□	119
195	15W	3000K 4000K	1710 1760	55°	□	131
195	21W	3000K 4000K	2360 2430	55°	□	131
195	29W	3000K 4000K	3170 3260	55°	□	131
230	15W	3000K 4000K	1690 1740	50°	□	135
230	21W	3000K 4000K	2330 2400	50°	□	135
230	29W	3000K 4000K	3130 3220	50°	□	135



L90B10
>60.000h

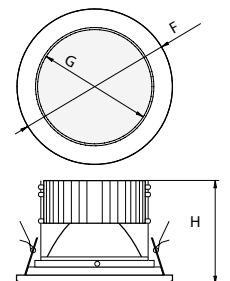

	H	F	G
Ø136	115	155	113
Ø175	120	195	150
Ø212	120	230	185



BARI DL MOVE LED

KENMERKEN / CARACTÉRISTIQUES

Ø	W	CT	Lm		COLOUR	€ PRICE
135	15W	3000K 4000K	1610 1660	55°	<input type="checkbox"/>	112
135	21W	3000K 4000K	2220 2290	55°	<input type="checkbox"/>	112
160	15W	3000K 4000K	1530 1580	45°	<input type="checkbox"/>	120
160	21W	3000K 4000K	2110 2180	45°	<input type="checkbox"/>	120



L90B10
>60.000h

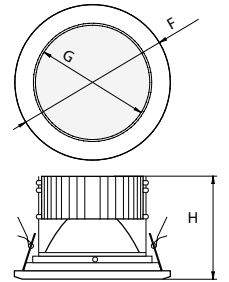

	H	F	G
Ø118	120	135	79
Ø144	130	160	95



BARI ECO DL LED

KENMERKEN / CARACTÉRISTIQUES

Ø	W	CT	Lm	COLOUR	€ PRICE
195	10W	3000K 4000K	1140 1160	<input type="checkbox"/>	72
195	15W	3000K 4000K	1560 1590	<input type="checkbox"/>	83
235	15W	3000K 4000K	1620 1660	<input type="checkbox"/>	84
235	19W	3000K 4000K	2060 2090	<input type="checkbox"/>	84
235	28W	3000K 4000K	2780 2830	<input type="checkbox"/>	84



L80B10
>72.000h

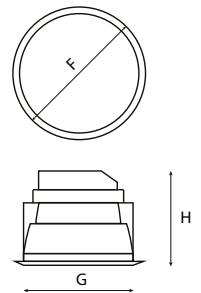

	H	F	G
Ø180	102	195	160
Ø220	111	235	210



BARI DL IP65 LED

KENMERKEN / CARACTÉRISTIQUES

Ø	W	CT	Lm	COLOUR	€ PRICE
245	15W	3000K 4000K	1670 - 1720	☐	173
245	21W	3000K 4000K	2300 - 2380	☐	173
245	29W	3000K 4000K	3090 - 3190	☐	176



option

option

Ø 212

option

L90B10

>60.000h

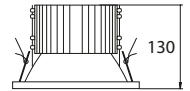
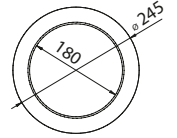



9 BARI Q LED

NEW

De **BARI Q LED** is de meest recente uitbreiding van de BARI-reeks. Door middel van een interessante prijs biedt de **BARI Q LED** een budgetvriendelijke oplossing voor standaardtoepassingen.

Le **BARI Q LED** est l'extension la plus récente de la gamme BARI. Avec un prix attractif, le BARI Q LED offre une solution économique pour les applications standards.

BARI Q LED



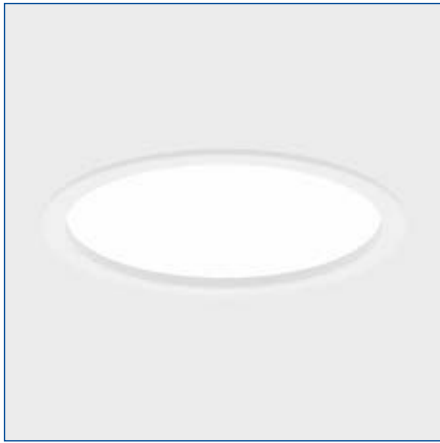

BARI Q LED

ALGEMEEN / GÉNÉRALITÉS

TYPE inbouw plafond / encastrément plafond

MATERIAL aluminium

DIFFUSER OPAL

OPTION dimming: DALI

KENMERKEN / CARACTÉRISTIQUES

Ø	W	CT	Lm	COLOR	€ PRICE
155	11W	3000K 4000K	1480 1510	☐	64
155	16W	3000K 4000K	2040 2090	☐	64
225	17W	3000K 4000K	2410 2460	☐	68
225	22W	3000K 4000K	2950 3020	☐	68
225	26W	3000K 4000K	3510 3590	☐	68



L70B10
>50.000h

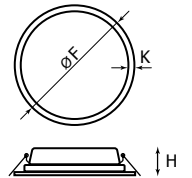

	H	F	K
Ø135	40	155	15
Ø205	40	225	15



ACCESSOIRES

	Ø	H	COLOUR	€ PRICE
Surface mounting housing IP20	Ø155	75	☐	39
Surface mounting housing IP20	Ø225	79	☐	39
Surface mounting housing IP44	Ø160	75	☐ ■	44
Surface mounting housing IP44	Ø228	75	☐ ■	52



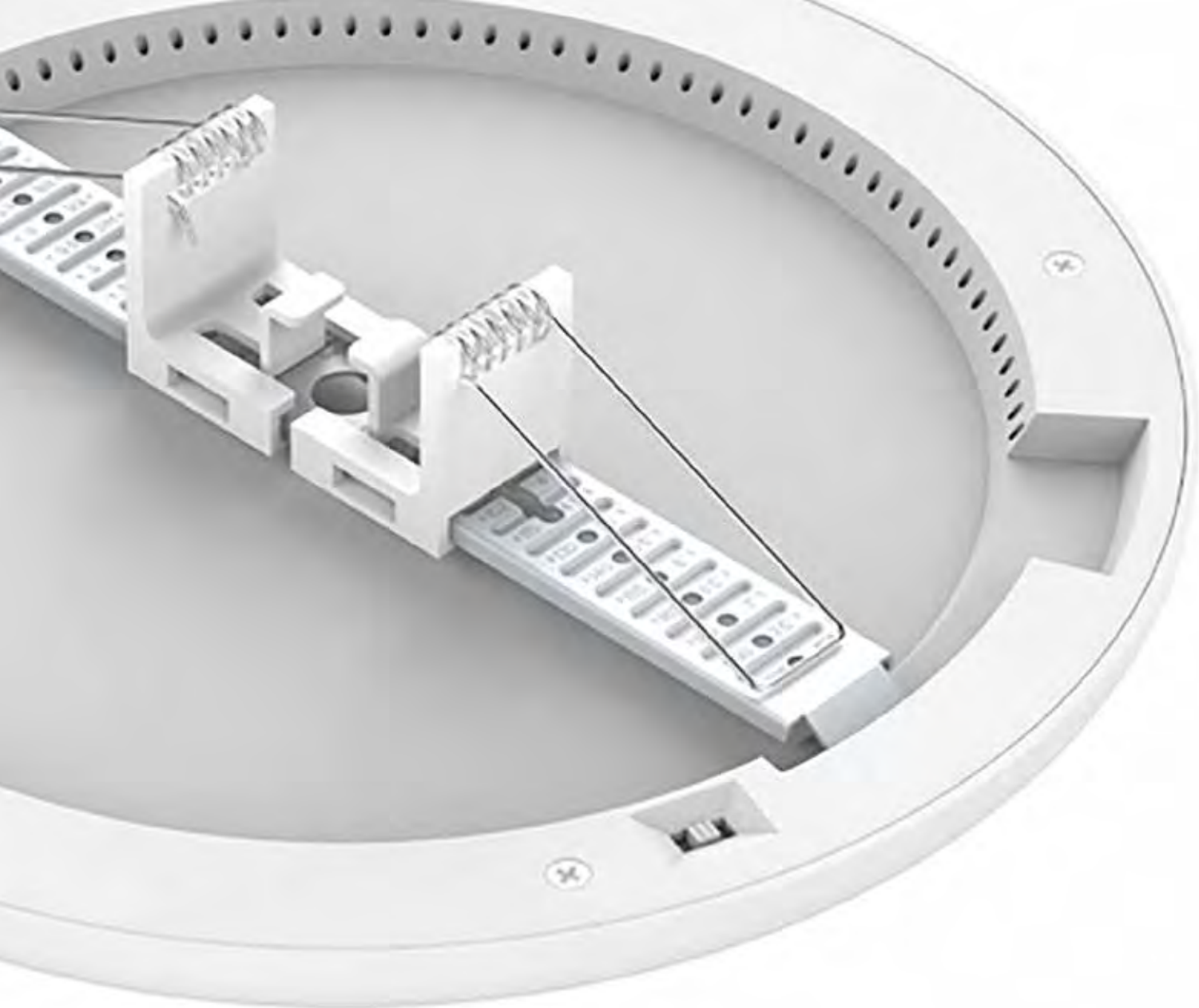

10 KAMELEON

Deze inbouw- en opbouwspot heeft een instelbare inbouwopening (65 mm-205 mm). Uitgerust met SMD Led voor een hoge lumenoutput en gelijkmatige lichtopbrengst. Dit toestel wordt geleverd met een instelbare kleurtemperatuur (3000/4000/5700K). Superslanke afdekring in aluminium. Alsook het wattage (10/13/16W) kan naar wens ingesteld worden in hetzelfde toestel

Ce spot encastré/apparent a une ouverture encastrée réglable (65 mm-205 mm). Equipé de LED SMD pour un flux Lumineux élevé et uniforme. Cet appareil est fourni avec une température réglable (3000K/4000K/5700K). Anneau ultra mince en aluminium. Les puissances (10/13/16W) peuvent également être programmées dans le même appareil selon vos souhaits.

KAMELEON



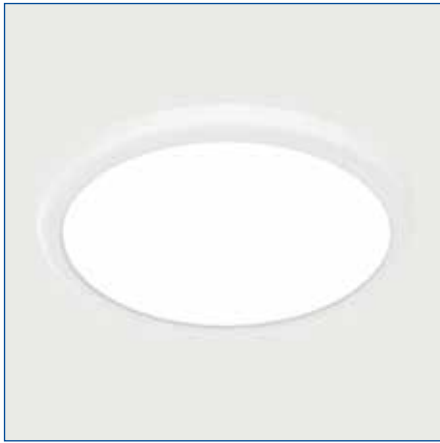

KAMELEON ROUND

ALGEMEEN / GÉNÉRALITÉS

TYPE inbouw muur, plafond / encastrément mur, plafond

MATERIAL PC / aluminium

CT instelbaar / réglable 3000K | 4000 K | 5700K

KENMERKEN / CARACTÉRISTIQUES

W	instelbaar / réglable	Lm	COLOUR	€ PRICE
10W	3000K 4000K 5700K	950 1000	☐	44
13W	3000K 4000K 5700K	1200 1450	☐	44
16W	3000K 4000K 5700K	1500 1800	☐	44



L90B10
>50.000h

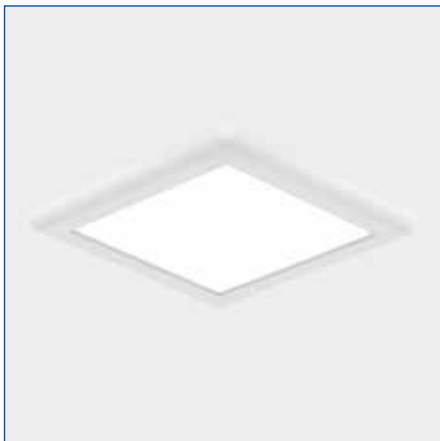
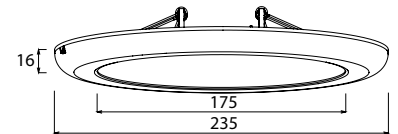

KAMELEON SQUARE

KENMERKEN / CARACTÉRISTIQUES

W	instelbaar / réglable	Lm	COLOUR	€ PRICE
10W	3000K 4000K 5700K	950 1000	☐	44
13W	3000K 4000K 5700K	1200 1450	☐	44
16W	3000K 4000K 5700K	1500 1800	☐	44



L90B10
>50.000h

NEW

F(L)ood concept

Een goede lichtkwaliteit helpt de klant om de juiste beslissingen te nemen bij de aankoop van hun voeding. Naast zijn functionele waarde heeft licht een sleutelfunctie bij het creëren van een onderscheidende winkel. Het is niet alleen belangrijk om de producten te onderscheiden maar ook een aangenaam algemeen gevoel te geven binnen in de winkel.

Licht met verschillende lichttemperaturen en kleurweergave wisselen de aantrekkelijkheid van de producten bij het ondersteunen van hun natuurlijke kleuren.

Fruit & groenten



De fruit- en groentenafdeling zijn vaak het centraal punt van de winkel bevindt zich vaak helemaal vooraan. De kleuren van fris, vers en smakelijk uitziende fruit & groenten overtuigt de klant tot kopen en geeft een eerste positieve indruk van het geheel.

Brood/Kaas



Weinig dingen zien er op een zondagochtend zo verleidelijk uit als pas afgebakken broodjes en goudgeel gerijpte kaas. De GOLD-modules geven een extra warmgouden kleur.

Vlees/Gevogelte



Lichtbronnen met "**vlees**"-module zijn ideaal om de versheid van het uitgestalde vlees te benadrukken. Hiervoor wordt gebruik gemaakt van extra rode tonen.

Vis/diepvriesproducten



Vis- en diepvriesproducten worden tentoongesteld op speciale plaatsen waar lage temperaturen worden behouden. Koud wit licht is de basis van de "**fish**"-module om de perceptie van versheid te behouden.



F(L)ood concept

Une bonne qualité de lumière aide le client à prendre les bonnes décisions lors de l'achat de sa nourriture.

En plus de sa valeur fonctionnelle, la lumière a un rôle clé dans la création d'un magasin distinctif.

Il est important, non seulement de mettre l'accent sur les produits, mais aussi de créer un sentiment agréable à l'intérieur du magasin.

La lumière avec différentes couleurs de températures et un rendu des couleurs différentes augmente l'attractivité des produits tout en accentuant leurs couleurs naturelles.

Fruits et légumes



La division des fruits et légumes est souvent le point central du magasin, surtout près de l'entrée. La couleur des fruits et légumes frais et savoureux va convaincre le client à acheter et donne également une première impression positive de l'ensemble.

Viande/Volaille



Les sources lumineuses avec **le module «viande»** sont idéales pour souligner la fraîcheur de la viande exposée, tout en utilisant des tons rouges supplémentaires.

Pain/Fromage



Le dimanche matin, il y a peu de choses qui semblent plus attirantes que des petits pains chauds et du fromage bien doré. Les modules GOLD donnent une extra couleur dorée chaude.

Poisson/produits surgelés



Ces produits sont présentés dans des endroits spéciaux où de basses températures doivent être maintenues. La lumière blanche froide est à la base **du module «poisson»** pour maintenir cette sensation de fraîcheur.





11 FLO fix

Deze **FLO LED** is een vast inbouwtoestel met een vermogen van 17W of 24W. Dit toestel heeft een lichtsterkte van 2400 tot 3500Lm en is leverbaar met een 15°, 24° of 60° reflector. De FLO LED bestaat in ronde of vierkante uitvoering en vaste of kantelbare uitvoering.

Ce **FLO LED** est un appareil fixe encastré d'une puissance de 17W ou 24W, avec un réflecteur de 36°. Cet appareil a une intensité lumineuse de 2400 à 3500Lm et est disponible avec un réflecteur de 15°, 24° ou 60° en option. Le FLO LED existe en version ronde ou carrée et fixe ou orientable.

FLO

ALGEMEEN / GÉNÉRALITÉS

TYPE inbouw plafond / encastrément plafond

MATERIAL aluminium | polymethyl methacrylaat

OPTION dimming

KENMERKEN / CARACTÉRISTIQUES

W	CT	Lm	COLOUR	€ PRICE
17W	3000K 4000K	2200 2300	□ ■ ■	140
24W	3000K 4000K	3100 3250	□ ■ ■	140
32W	3000K 4000K	4350 4550	□ ■ ■	145



L80B10
>50.000h

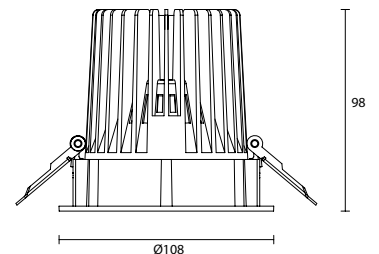

FLO



12 FLO move

Deze **FLO LED** is een richtbaar inbouwtoestel met een vermogen van 17W of 24W. Dit toestel heeft een lichtsterkte van 2200 tot 4350Lm en is leverbaar met een 15°, 24° of 60° reflector. De FLO LED bestaat in ronde of vierkante uitvoering en vaste of kantelbare uitvoering.

Ce **FLO LED** est un luminaire encastré LED orientable, réflecteur de 36°. Existe en rond ou carré. L'appareil carré existe également en module double, 17W ou 24W. De 2200 à 4350Lm, rendement allant jusqu'à 145Lm/W. Réflecteurs de 15°, 24° ou 60° en option.

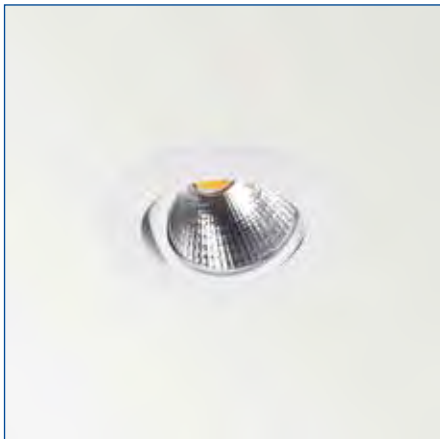

FLO

ALGEMEEN / GÉNÉRALITÉS

TYPE inbouw plafond / encastrément plafond

MATERIAL aluminium | polymethyl methacrylaat

OPTION dimming

FLO ROUND

KENMERKEN / CARACTÉRISTIQUES

W	CT	Lm	COLOUR	€ PRICE
17W	3000K 4000K	2200 2400	<input type="checkbox"/> <input type="checkbox"/> <input type="checkbox"/>	146
24W	3000K 4000K	3100 3250	<input type="checkbox"/> <input type="checkbox"/> <input type="checkbox"/>	146
32W	3000K 4000K	4350 4530	<input type="checkbox"/> <input type="checkbox"/> <input type="checkbox"/>	150

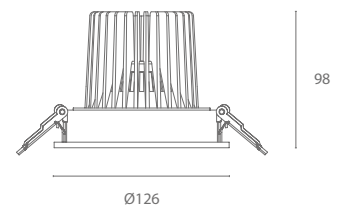

FLO ROUND



FLO SQUARE





FLO SQUARE SINGLE

KENMERKEN / CARACTÉRISTIQUES

W	CT	Lm	COLOUR	€ PRICE
17W	3000K 4000K	2100 2300	□ ■ ■	146
24W	3000K 4000K	2900 3200	□ ■ ■	146

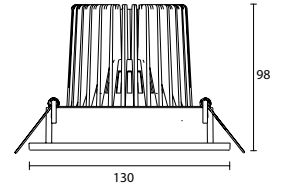

FLO SQUARE DOUBLE

KENMERKEN / CARACTÉRISTIQUES

W	CT	Lm	COLOUR	€ PRICE
2 x 17W	2700K 3000K 4000K	2 x 2200	□ ■ ■	254
2 x 24W	2700K 3000K 4000K	2 x 3100	□ ■ ■	254

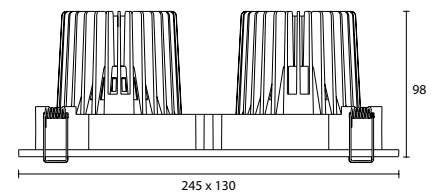



13 FLOX fix

FLOX Fix is een hoge rendement downlight met reflector om de lumenoutput te versterken. Deze downlight is leverbaar in grijs, wit of zwart en met een reflector van 18°, 28° of 60°. Deze is leverbaar met dimbare driver en kan het uitgerust worden met een speciale chips voor de voedings- of retailsector.

Le **FLOX Fix** est un downlight à haut rendement avec réflecteur afin de renforcer le lumenoutput. Il est disponible en gris, blanc ou noir et avec des réflecteurs optionnels de 18°, 28° ou 60°. Egalement disponible avec un driver dimmable. Peut être équipé de chips spéciaux pour l'industrie alimentaire ou le secteur de la vente au détail.

FLOX

ALGEMEEN / GÉNÉRALITÉS

TYPE inbouw plafond / encastrément plafond

MATERIAL aluminium | polymethyl methacrylaat

OPTION dimming

KENMERKEN / CARACTÉRISTIQUES

W	CT	Lm	COLOUR	€ PRICE
24W	3000K 4000K	3100 3250	☐ ■ ■	184
42W	3000K 4000K	5300 5450	☐ ■ ■	189



L80B10
>50.000h

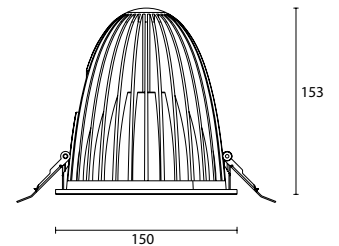

FLOX



14 FLOX move

De **FLOX move** is een hoge rendement downlight, leverbaar in grijs, wit of zwart met een reflector van 18°, 28° of 60°. Het toestel is leverbaar met een dimbare driver en kan uitgerust worden met een speciale reflector voor de voedings- of retailsector.

Le **FLOX move** est un downlight orientable à haut rendement avec réflecteur afin de renforcer le lumenoutput. Il est disponible en gris, blanc ou noir et avec des réflecteurs optionnels de 18°, 28° ou 60°. Egalement disponible avec un driver dimmable. Peut être équipé de filtres spéciaux pour l'industrie alimentaire ou le secteur de la vente au détail.



FLOX

ALGEMEEN / GÉNÉRALITÉS

TYPE inbouw plafond / encastrément plafond

MATERIAL aluminium | polymethyl methacrylaat

OPTION dimming: 1-10V | DALI

KENMERKEN / CARACTÉRISTIQUES

W	CT	Lm	COLOUR	€ PRICE
24W	3000K 4000K	3100 3250	□ ■ ■	189
42W	3000K 4000K	5300 5500	□ ■ ■	193



L80B10
>50.000h

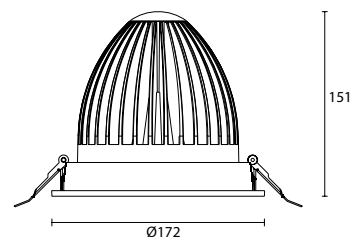

FLOX





15 MOVIMENTO

De **MOVIMENTO LED** is een LED inbouwtoestel met dubbele ring waardoor men in alle richtingen kan richten. Dit toestel heeft een vermogen van 24W of 42W en lichtsterkte tussen de 2400 en 3500Lm. Dit toestel is leverbaar met een 16° of 24° reflector.

Le **MOVIMENTO LED** est un luminaire encastré LED avec anneau double permettant une orientation dans toutes les directions, réflecteur de 42°. 24W / 42W, de 2400 à 3500Lm, rendement allant jusqu'à 148lm/W et des réflecteurs de 16° ou 24° en option.

MOVIMENTO

ALGEMEEN / GÉNÉRALITÉS

TYPE inbouw plafond / encastrément plafond

MATERIAL aluminium | polymethyl methacrylaat

OPTION dimming

KENMERKEN / CARACTÉRISTIQUES

W	CT	Lm	COLOUR	€ PRICE
24W	2700K 3000K 4000K	2950 3100 3300	☐	243
48W	2700K 3000K 4000K	5050 5300 5700	☐	247



L80B10
>50.000h

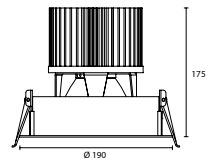

MOVIMENTO



16 LEAN DL

De **LEAN DL** downlight is een banaanspot; perfect richtbaar in alle richtingen en hierdoor ideaal om rekken en muren uit te lichten. De LEAN is verkrijgbaar met verschillende filters, lumenoutputs, wattages en kleuren. Daarnaast is het toestel ook verkrijgbaar als LEAN DL MINI.

Le downlight **LEAN DL** est un spot « banane », entièrement conçu en aluminium moulé sous pression. Parfaitement réglable dans toutes les directions et donc très performant pour l'éclairage de murs ou d'étagères. Il est disponible avec différents filtres, puissances, couleurs, ... Egalement disponible en plus petit: LEAN DL MINI.

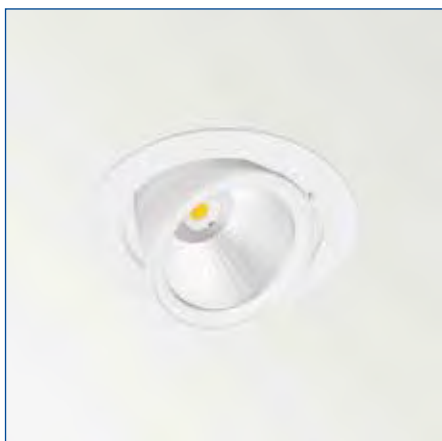

LEAN DL

ALGEMEEN / GÉNÉRALITÉS

TYPE	inbouw plafond / encastrément plafond
MATERIAL	die cast aluminium
CT	2700K 4000K 5000K
OPTION	dimming: push DALI

KENMERKEN / CARACTÉRISTIQUES

W	CT	Lm	CRI	COLOUR	€ PRICE
42W	3000K	3898	>80	<input type="checkbox"/> <input type="checkbox"/> <input type="checkbox"/>	157
55W	3000K	5736	>90	<input type="checkbox"/> <input type="checkbox"/> <input type="checkbox"/>	169



LEAN DL MINI

KENMERKEN / CARACTÉRISTIQUES

W	CT	Lm	CRI	COLOUR	€ PRICE
36W	3000K	2931	>80	<input type="checkbox"/> <input type="checkbox"/> <input type="checkbox"/>	112



L80B10
>50.000h

LEAN DL



17 FIRST

FIRST is een kardan inbouwdownlight. Deze is speciaal voor de retail ontworpen en is verkrijgbaar met verschillende filters, lumenoutputs, wattages, kleuren, ... Ze vervangen perfect de klassieke gasontladingsarmaturen. De FIRST bestaat in een ronde of vierkante uitvoering.

FIRST est downlight en aluminium moulé sous pression à encastrer. Il est conçu spécifiquement pour les magasins et est disponible avec différents filtres, puissances, couleurs, ... et peut être utilisé soit comme éclairage général soit comme éclairage d'accentuation. Il remplace parfaitement les luminaires à décharge classique. Le FIRST existe également un version ronde ou carrée.



FIRST

ALGEMEEN / GÉNÉRALITÉS

TYPE inbouw plafond / encastrément plafond

MATERIAL die cast aluminium

OPTION dimming: DALI

FIRST CIRCLE

KENMERKEN / CARACTÉRISTIQUES

W	CT	Lm	COLOUR	€ PRICE
42W	3000K 4000K	3982 4300	□ ■ ●	140
55W	3000K 4000K	5027 5500	□ ■ ●	140



L80B10
>50.000h

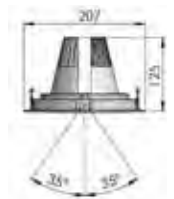

FIRST CIRCLE





FIRST SINGLE

KENMERKEN / CARACTÉRISTIQUES

W	CT	Lm	COLOUR	€ PRICE
20W	2700K 3000K 4000K	2725 2850	□ ■ ●	140
35W	2700K 3000K 4000K	4425	□ ■ ●	120
43W	2700K 3000K 4000K	4975	□ ■ ●	140



L80B10
>50.000h

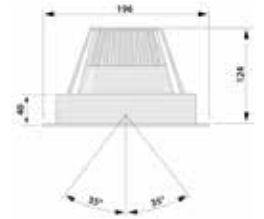

FIRST DUO

KENMERKEN / CARACTÉRISTIQUES

W	CT	Lm	COLOUR	€ PRICE
2 x 20W	2700K 3000K 4000K	2 x 2850	□ ■ ●	280
2 x 35W	2700K 3000K 4000K	2 x 4425	□ ■ ●	280
2 x 43W	2700K 3000K 4000K	2 x 4975	□ ■ ●	280



L80B10
>50.000h



FIRST TRIO

KENMERKEN / CARACTÉRISTIQUES

W	CT	Lm	COLOUR	€ PRICE
3 x 20W	2700K 3000K 4000K	3 x 2850	□ ■ ●	360
3 x 35W	2700K 3000K 4000K	3 x 4425	□ ■ ●	360
3 x 43W	2700K 3000K 4000K	3 x 4975	□ ■ ●	360



L80B10
>50.000h



18 WALLY

De **WALLY** is een kantelbare ledspot om muren uit te lichten, verkrijgbaar in klein en groot formaat. Daarnaast zijn er modules beschikbaar voor zowel voedings- als retailsector. Op aanvraag is ook CRI90 mogelijk.

Le **WALLY** est un spot LED inclinable destiné à éclairer des murs. L'appareil existe en 2 grandeurs différentes. La quantité de lumière émise est de plus de 5100Lm. Des modules pour l'alimentation et le secteur vestimentaire sont disponibles. CRI90 possible sur demande.



WALLY

ALGEMEEN / GÉNÉRALITÉS

TYPE inbouw plafond / encastrément plafond

MATERIAL aluminium | polymethyl methacrylaat

WALLY MEDIUM

KENMERKEN / CARACTÉRISTIQUES

W	K	Lm	COLOUR	€ PRICE
28W	2700K 3000K	3312 3659	□ ■	200



78°x100° 218x125 MODULES

L80B10
>50.000h

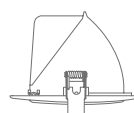

145

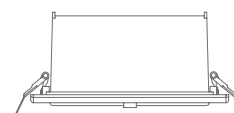

100

100

238



WALLY MAXI

KENMERKEN / CARACTÉRISTIQUES

W	K	Lm	COLOUR	€ PRICE
42W	2700K 3000K	5100 5300	□ ■ ■	281



70°x75° 225x135 MODULES

L80B10
>50.000h

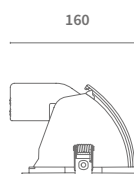

145

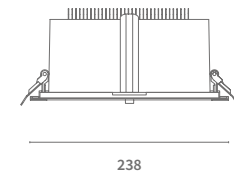

107

114

238

WALLY





19 SWAP

De **SWAP**-familie bevat een erg breed uitgewerkt aanbod aan inbouw LED spots. Het is een leuke, eenvoudige spot om mee te werken en de toepassingen zijn erg divers. Vooreerst zijn er 4 maten (S, M, L, XL) en 2 vormen (rond & vierkant), naast een symmetrische versie is er ook een asymmetrische versie beschikbaar maar ook een IP65-variant voor badkamers. De SWAP is reeds een interessante spot gebleken bij relighting-projecten. Er past namelijk steeds een SWAP in een bestaand gat (Ø 62mm-126mm).

La famille **SWAP** propose une très large gamme de spots encastrés LED. C'est un spot sympa et simple à utiliser, avec un large domaine d'applications. Tout d'abord il existe en 4 tailles (S, M, L, XL) et 2 formes (rond et carré), à côté de la version symétrique, il existe aussi une version asymétrique, mais également une variante IP65 pour les salles de bains. Le SWAP s'est déjà avéré être un spot intéressant pour les projets de relighting. Il y a toujours un SWAP qui s'adapte à un trou existant (diamètre 62mm-126mm).



SWAP



SWAP SQUARE





SWAP S

ALGEMEEN / GÉNÉRALITÉS

TYPE inbouw plafond / encastrément plafond

MATERIAL aluminium | polycarbonate

OPTION dimming: push | phase cut | DALI

KENMERKEN / CARACTÉRISTIQUES

W	CT	Lm	COLOUR	€ PRICE IP20	€ PRICE IP65
5W	2700K	675	☐ ■ ■ ■ ■ ■ ■ ■ ■	59	70
5W	3000K	700	☐ ■ ■ ■ ■ ■ ■ ■ ■	59	70
5W	4000K	710	☐ ■ ■ ■ ■ ■ ■ ■ ■	59	70
7W	2700K	910	☐ ■ ■ ■ ■ ■ ■ ■ ■	69	80
7W	3000K	940	☐ ■ ■ ■ ■ ■ ■ ■ ■	69	80
7W	4000K	960	☐ ■ ■ ■ ■ ■ ■ ■ ■	69	80



L80B10
>60.000h

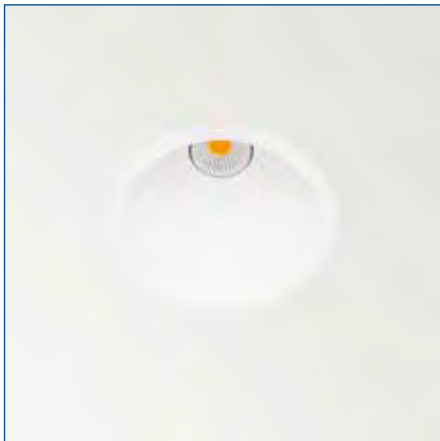
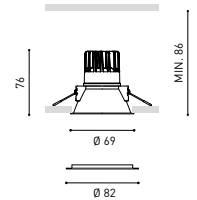

SWAP M

KENMERKEN / CARACTÉRISTIQUES

W	CT	Lm	COLOUR	€ PRICE IP20	€ PRICE IP65
5W	2700K	675	☐ ■ ■ ■ ■ ■ ■ ■ ■	60	71
5W	3000K	700	☐ ■ ■ ■ ■ ■ ■ ■ ■	60	71
5W	4000K	710	☐ ■ ■ ■ ■ ■ ■ ■ ■	60	71
7W	2700K	910	☐ ■ ■ ■ ■ ■ ■ ■ ■	70	82
7W	3000K	940	☐ ■ ■ ■ ■ ■ ■ ■ ■	70	82
7W	4000K	960	☐ ■ ■ ■ ■ ■ ■ ■ ■	70	82



L80B10
>60.000h

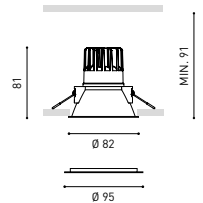



SWAP L

KENMERKEN / CARACTÉRISTIQUES

W	CT	Lm	COLOUR	€ PRICE IP20	€ PRICE IP65
5W	2700K	675	☐ ■ ■ ■ ■ ■ ■	61	73
5W	3000K	700	☐ ■ ■ ■ ■ ■ ■	61	73
5W	4000K	710	☐ ■ ■ ■ ■ ■ ■	61	73
7W	2700K	910	☐ ■ ■ ■ ■ ■ ■	71	83
7W	3000K	940	☐ ■ ■ ■ ■ ■ ■	71	83
7W	4000K	960	☐ ■ ■ ■ ■ ■ ■	71	83



L80B10
>60.000h

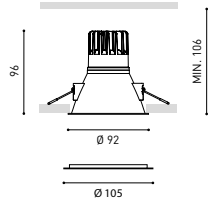

SWAP XL

KENMERKEN / CARACTÉRISTIQUES

W	CT	Lm	COLOUR	€ PRICE IP20	€ PRICE IP65
5W	2700K	675	☐ ■ ■ ■ ■ ■ ■	64	75
5W	3000K	700	☐ ■ ■ ■ ■ ■ ■	64	75
5W	4000K	710	☐ ■ ■ ■ ■ ■ ■	64	75
7W	2700K	910	☐ ■ ■ ■ ■ ■ ■	74	85
7W	3000K	940	☐ ■ ■ ■ ■ ■ ■	74	85
7W	4000K	960	☐ ■ ■ ■ ■ ■ ■	74	85



L80B10
>60.000h

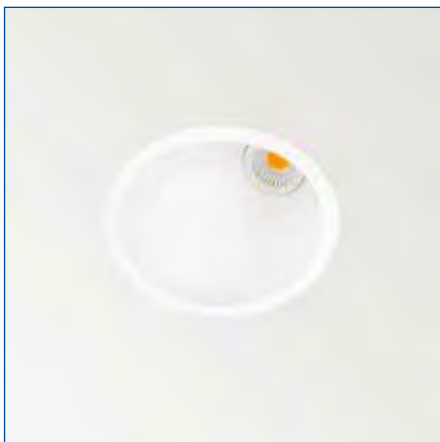
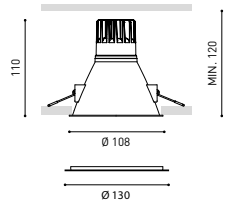

SWAP M ASYMMETRIC

KENMERKEN / CARACTÉRISTIQUES

W	CT	Lm	COLOUR	€ PRICE IP20	€ PRICE IP65
5W	2700K	675	☐ ■ ■ ■ ■ ■ ■	61	73
5W	3000K	700	☐ ■ ■ ■ ■ ■ ■	61	73
5W	4000K	710	☐ ■ ■ ■ ■ ■ ■	61	73
7W	2700K	910	☐ ■ ■ ■ ■ ■ ■	71	83
7W	3000K	940	☐ ■ ■ ■ ■ ■ ■	71	83
7W	4000K	960	☐ ■ ■ ■ ■ ■ ■	71	83



L80B10
>60.000h

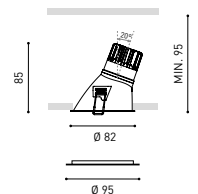



SWAP L ASYMMETRIC

KENMERKEN / CARACTÉRISTIQUES

W	CT	Lm	COLOUR	€ PRICE IP20	€ PRICE IP65
5W	2700K	675	□ ■ ■ ■ ■ ■	62	74
5W	3000K	700	□ ■ ■ ■ ■ ■	62	74
5W	4000K	710	□ ■ ■ ■ ■ ■	62	74
7W	2700K	910	□ ■ ■ ■ ■ ■	73	84
7W	3000K	940	□ ■ ■ ■ ■ ■	73	84
7W	4000K	960	□ ■ ■ ■ ■ ■	73	84



L80B10
>60.000h

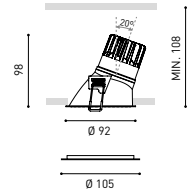

SWAP SQUARE

KENMERKEN / CARACTÉRISTIQUES

W	CT	Lm	COLOUR	€ PRICE IP20	€ PRICE IP65
5W	2700K	675	□ ■ ■ ■ ■ ■	62	74
5W	3000K	700	□ ■ ■ ■ ■ ■	62	74
5W	4000K	710	□ ■ ■ ■ ■ ■	62	74
7W	2700K	910	□ ■ ■ ■ ■ ■	73	84
7W	3000K	940	□ ■ ■ ■ ■ ■	73	84
7W	4000K	960	□ ■ ■ ■ ■ ■	73	84



L80B10
>60.000h

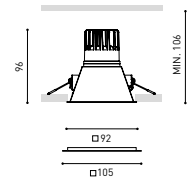

SWAP SQUARE ASYMMETRIC

KENMERKEN / CARACTÉRISTIQUES

W	CT	Lm	COLOUR	€ PRICE IP20	€ PRICE IP65
5W	2700K	675	□ ■ ■ ■ ■ ■	64	75
5W	3000K	700	□ ■ ■ ■ ■ ■	64	75
5W	4000K	710	□ ■ ■ ■ ■ ■	64	75
7W	2700K	910	□ ■ ■ ■ ■ ■	74	85
7W	3000K	940	□ ■ ■ ■ ■ ■	74	85
7W	4000K	960	□ ■ ■ ■ ■ ■	74	85



L80B10
>60.000h

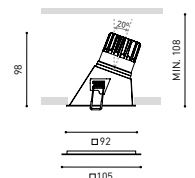



20 SHOT LIGHT

De **SHOT LIGHT** is een inbouwspot; ontworpen om zo klein en discreet mogelijk te verlichten. Het unieke aan deze spot met minimale afmetingen zit hem in het feit dat deze spot de lichtbron zo onzichtbaar mogelijk maakt. Hiervoor is de SHOT LIGHT uitgerust met een anti-verblindend oppervlak en een speciaal ontworpen micro-reflector die de lichtstralen perfect geleid zonder dat deze de zijkanten raken.

Un luminaire conçu pour constituer un point d'éclairage discret et de petite taille au plafond, permettant de masquer la source de l'éclairage tout en cherchant le meilleur confort visuel. Pour ce faire, il est équipé d'un écran anti-éblouissement et d'un micro-réflecteur (spécialement conçu) produisant un faisceau lumineux parfaitement défini.



SHOT LIGHT



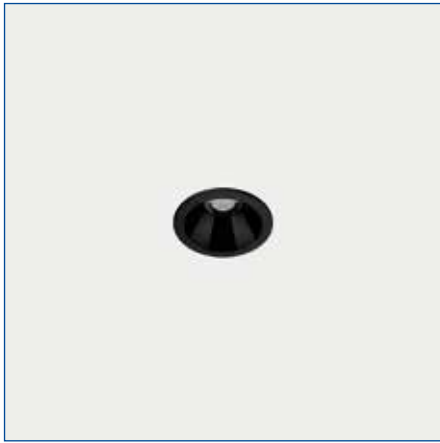

SHOT LIGHT

ALGEMEEN / GÉNÉRALITÉS

TYPE inbouw plafond / encastrément plafond

MATERIAL aluminium | acrylonitrile butadiene styrene

OPTION dimming: DALI

KENMERKEN / CARACTÉRISTIQUES

W	CT	Lm	A	COLOUR	€ PRICE
2,1W	2700K	190	17° 35°	☐ ■	87
2,1W	3000K	210	17° 35°	☐ ■	87
2,1W	4000K	250	17° 35°	☐ ■	87



L80B10
>41.000h

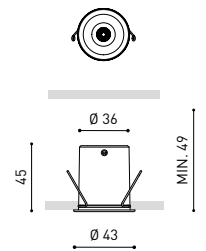

SHOT LIGHT TRIMLESS

KENMERKEN / CARACTÉRISTIQUES

W	CT	Lm	A	COLOUR	€ PRICE
2,1W	2700K	190	19° 38°	☐ ■	87
2,1W	3000K	210	19° 38°	☐ ■	87
2,1W	4000K	250	19° 38°	☐ ■	87



L80B10
>41.000h

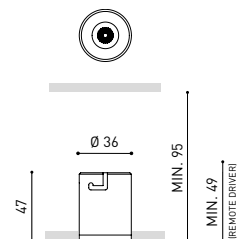

ACCESSOIRES

Trimless accessoire CODE € PRICE
 A269-00-00 € 11



Trimless accessoire 2 A269-00-02 € 24



Trimless accessoire 3 A269-00-03 € 32

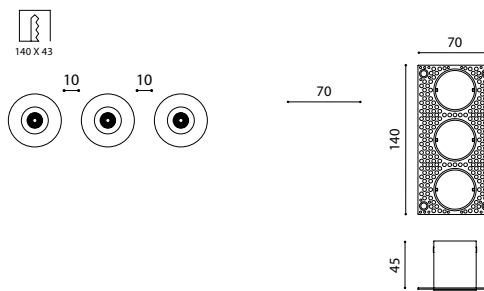

Trimless accessoire 4 2x A269-00-02 € 48

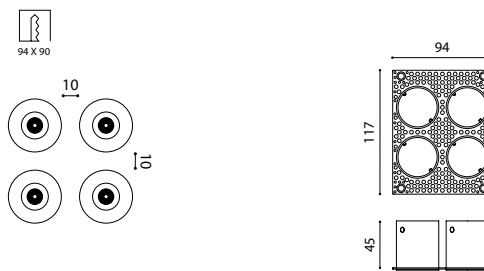



SHOT LIGHT M

KENMERKEN / CARACTÉRISTIQUES

W	CT	Lm	COLOUR	€ PRICE
5W	2700K	675	☐ ■	110
5W	3000K	700	☐ ■	110
5W	4000K	710	☐ ■	110
6,5W	2700K	910	☐ ■	117
6,5W	3000K	940	☐ ■	117
6,5W	4000K	960	☐ ■	117



L80B10
>60.000h

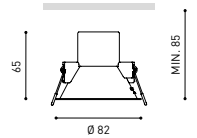
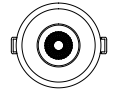

SHOT LIGHT M TRIMLESS

KENMERKEN / CARACTÉRISTIQUES

W	CT	Lm	COLOUR	€ PRICE
5W	2700K	675	☐ ■	111
5W	3000K	700	☐ ■	111
5W	4000K	710	☐ ■	111
6,5W	2700K	910	☐ ■	119
6,5W	3000K	940	☐ ■	119
6,5W	4000K	960	☐ ■	119



L80B10
>60.000h

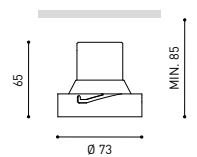

ACCESSOIRES

	CODE	€ PRICE
Trimless accessoire	A2980000	€ 14

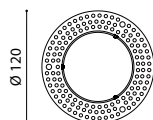



21 BLACK FOSTER

De **BLACK FOSTER** is een lineair inbouw- of trimlessstoestel die de "invisible black" eigenschappen deelt met de SHOT LIGHT familie (p. 60). Dit effect wordt verkregen doordat de behuizing de dieperliggende ledbron zo onzichtbaar mogelijk maakt. Hiervoor is de BLACK FOSTER uitgerust met een anti-verblindend oppervlak en speciaal ontworpen microreflector die de lichtstralen perfect geleid zonder dat deze de zijkanten raken. De BLACK FOSTER is ook verkrijgbaar als opbouwversie (zie pagina 112), alsook trimless inbouw.

Le **BLACK FOSTER** est un appareil linéaire encastré ou trimless qui partage les propriétés de l'«invisible black» avec la famille d'appareils SHOT LIGHT (p. 60). Cet effet est obtenu grâce au corps de l'appareil ou la source LED est implantée le plus profondément possible ; ce qui rend donc cette dernière invisible. Pour cela, le BLACK FOSTER est équipé d'une surface anti-éblouissement et d'un micro-réflecteur spécialement conçu pour guider parfaitement les rayons lumineux sans qu'ils n'heurtent les côtés. Le BLACK FOSTER est également disponible en version apparente (voir page 112), ainsi qu'en trimless.



BLACK FOSTER





BLACK FOSTER Recessed 1

ALGEMEEN / GÉNÉRALITÉS

TYPE inbouw plafond / encastrément plafond

MATERIAL PC | aluminium

OPTIONS dimming: push | DALI

KENMERKEN / CARACTÉRISTIQUES

W	CT	Lm	COLOUR	€ PRICE
2,1W	2700K	190	■	98
2,1W	3000K	210	■	98
2,1W	4000K	250	■	98



L80B10
>60.000h

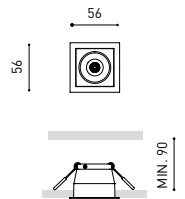

BLACK FOSTER Recessed 2

KENMERKEN / CARACTÉRISTIQUES

W	CT	Lm	COLOUR	€ PRICE
4,2W	2700K	380	■	153
4,2W	3000K	420	■	153
4,2W	4000K	500	■	153



L80B10
>60.000h

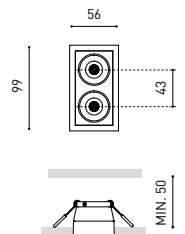

BLACK FOSTER HL Asymmetric Recessed 2

KENMERKEN / CARACTÉRISTIQUES

W	K	Lm	COLOUR	€ PRICE
4,2W	2700K	380	■	171
4,2W	3000K	420	■	171
4,2W	4000K	500	■	171



L80B10
>60.000h

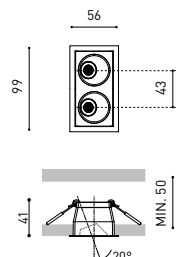



BLACK FOSTER Recessed 3

KENMERKEN / CARACTÉRISTIQUES

W	CT	Lm	COLOUR	€ PRICE
6,3W	2700K	570	■	168
6,3W	3000K	630	■	168
6,3W	4000K	750	■	168



L80B10
>60.000h

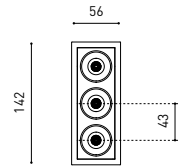

BLACK FOSTER HL Asymmetric Recessed 3

KENMERKEN / CARACTÉRISTIQUES

W	CT	Lm	COLOUR	€ PRICE
6,3W	2700K	570	■	189
6,3W	3000K	630	■	189
6,3W	4000K	750	■	189



L80B10
>60.000h

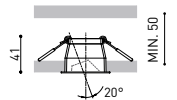
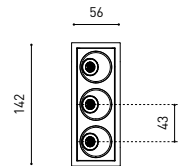

BLACK FOSTER Recessed 5

KENMERKEN / CARACTÉRISTIQUES

W	CT	Lm	COLOUR	€ PRICE
10,5W	2700K	950	■	204
10,5W	3000K	1050	■	204
10,5W	4000K	1250	■	204



L80B10
>60.000h

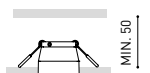
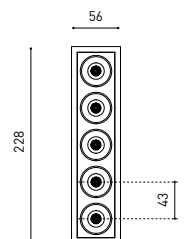



BLACK FOSTER HL Asymmetric Recessed 5

KENMERKEN / CARACTÉRISTIQUES

W	CT	Lm	COLOUR	€ PRICE
10,5W	2700K	950	■	204
10,5W	3000K	1050	■	204
10,5W	4000K	1250	■	204



option 38° 50x222 option

L80B10

>60.000h

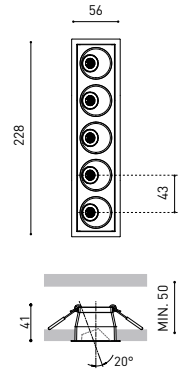

VARIATIES / VARIATIONS

Montage trimless





22 PUCK RECESSED

De **PUCK RECESSED** werd oorspronkelijk ontworpen als design opbouwtoestel voor algemene verlichting. Het typerende design met de breedstralende lens vervaardigd uit glas werd nu ook als inbouwversie uitgebracht.

Le **PUCK RECESSED** a été conçu à l'origine comme un appareil apparent design pour l'éclairage général. Le design atypique avec l'objectif grand angle en verre a maintenant également été révisité en version encastré.



PUCK RECESSED



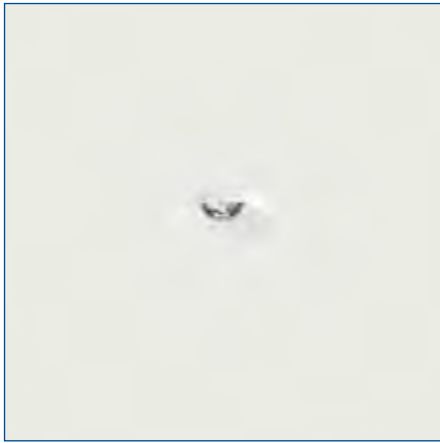

PUCK S HL Recessed

ALGEMEEN / GÉNÉRALITÉS

TYPE inbouw plafond / encastrément plafond

MATERIAL aluminium

OPTION dimming: push | DALI

KENMERKEN / CARACTÉRISTIQUES

W	CT	Lm	COLOUR	€ PRICE
5W	2700K	670	☐ ■	170
5W	3000K	700	☐ ■	170
5W	4000K	710	☐ ■	170



L80B10
>60.000h

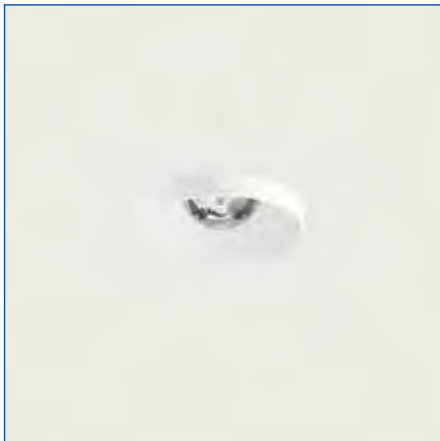
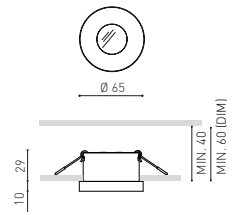

PUCK M HL Recessed

KENMERKEN / CARACTÉRISTIQUES

W	CT	Lm	COLOUR	€ PRICE
9W	2700K	1040	☐ ■	194
9W	3000K	1080	☐ ■	194
9W	4000K	1100	☐ ■	194



L80B10
>60.000h

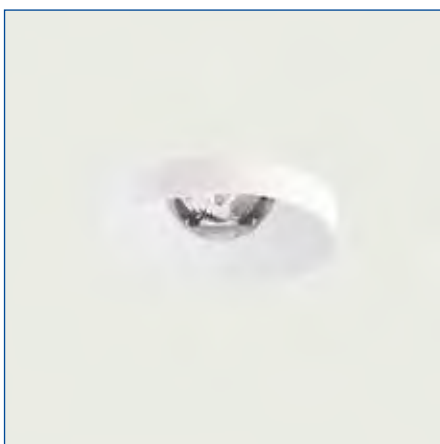
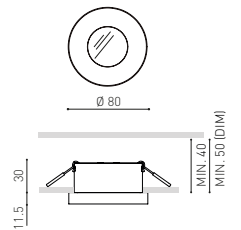

PUCK L HL Recessed

KENMERKEN / CARACTÉRISTIQUES

W	CT	Lm	COLOUR	€ PRICE
12W	2700K	1550	☐ ■	230
12W	3000K	1610	☐ ■	230
12W	4000K	1640	☐ ■	230



L80B10
>60.000h

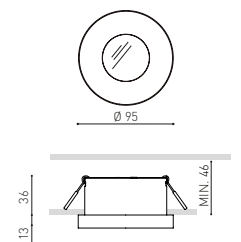



23 DUOMO

De **DUOMO** is een elegante IP65 inbouwdownlight met hoog vermogen tot 41W-5200Lm geschikt voor buitentoepassingen. Daarnaast wordt met de typerende lensoptiek, ondanks het hoge vermogen, een zeer lage UGR<19 behaald.

Le **DUOMO** est un downlight IP65 encastré élégant avec une puissance élevée jusqu'à 41W-5200Lm adapté pour l'extérieur. Malgré la puissance élevée, un UGR <19 très bas est obtenu grâce à l'optique spécifique des lentilles.



DUOMO

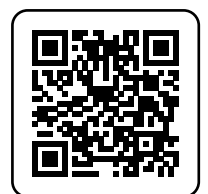



DUOMO

ALGEMEEN / GÉNÉRALITÉS

TYPE inbouw plafond / encastrément plafond

MATERIAL aluminium | PC

OPTION dimming: push | DALI

KENMERKEN / CARACTÉRISTIQUES

IP	W	CT	Lm	COLOUR	€ PRICE
IP65/IP20	16,5W	3000K	2450	☐	309
IP65/IP20	16,5W	4000K	2500	☐	309
IP65/IP20	41W	3000K	5100	☐	342
IP65/IP20	41W	4000K	5200	☐	342



option 42° Ø 177

L80B10

>60.000h

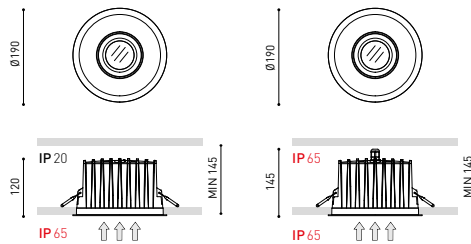



24 KURA X1 | X3 | X5

NEW

De **KURA** is een strak en elegant inbouwtoestel, beschikbaar met 1, 3 of 5 lichtpunten.

Het toestel is IP65 en dus geschikt voor zowel binnen- als buitentoepassingen.

Le **KURA** est une appareil encastrée élégante et raffinée, disponible avec 1, 3 ou 5 points lumineux.

L'appareil est conforme à la norme IP65 et convient donc aux applications intérieures et extérieures.

KURA X1|X3|X5



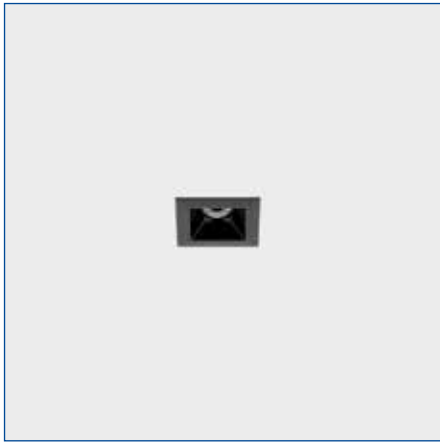

KURA X1

ALGEMEEN / GÉNÉRALITÉS

TYPE inbouw plafond / encastrément plafond

MATERIAL polycarbonate

DIFFUSER PMMA

OPTION dimming: push | 1-10V | DALI

KENMERKEN / CARACTÉRISTIQUES

W	CT	Lm	COLOUR	€ PRICE
3W	2700K 3000K 4000K	180	□ ■	66



KURA X3

KENMERKEN / CARACTÉRISTIQUES

W	CT	Lm	COLOUR	€ PRICE
7,5W	2700K 3000K 4000K	540	□ ■	115

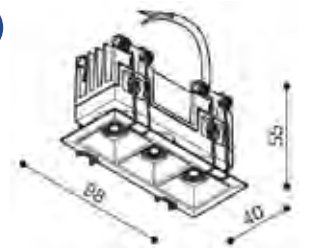

KURA X5

KENMERKEN / CARACTÉRISTIQUES

W	CT	Lm	COLOUR	€ PRICE
12,5W	2700K 3000K 4000K	900	□ ■	147

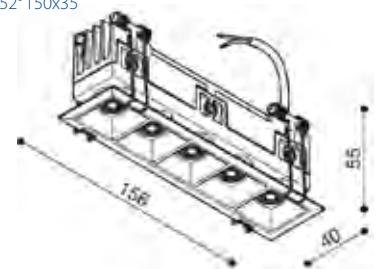



25 POP UP

De **POP UP** is één van de kleinste richtbare inbouwspots ter wereld. Zijn zuivere lijnen en beperkte afmetingen maken de POP-UP tot het ideale toestel om te plaatsen in krappe ruimtes. De lichtopbrengst is dermate hoog dat het te belichten object voldoende geaccentueerd kan worden vanuit het plafond.

Le **POP UP** est un des plus petits spots encastrés orientables au monde. Ses dimensions réduites et ses lignes épurées en font un luminaire idéal pour être placé dans des espaces où un encombrement minime est recherché. Grâce à son flux lumineux, le POP UP est capable d'assurer des fonctions d'éclairage d'accentuation à partir du plafond.

EUROPEAN
PRODUCT
DESIGN
AWARD



POP UP



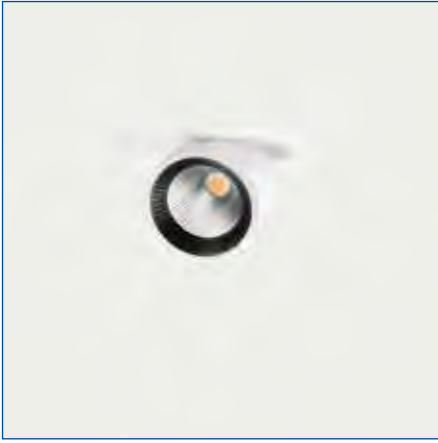

POP UP

ALGEMEEN / GÉNÉRALITÉS

TYPE inbouw plafond / encastrément plafond

MATERIAL aluminium | polycarbonate

OPTION dimming: push | DALI

KENMERKEN / CARACTÉRISTIQUES

W	CT	Lm	A	COLOUR	€ PRICE
6,5W	2700K	610	20° 30° 56°	□ ■	192
6,5W	3000K	640	20° 30° 56°	□ ■	192
6,5W	4000K	660	20° 30° 56°	□ ■	192



option Ø 79 20-30-56°

L80B10
>60.000h

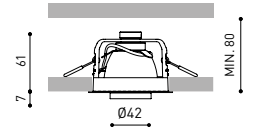



26 NEO

NEW

De **NEO** heeft een herkenbaar cilindervormig design en maakt deel uit van een volledige familie voor inbouw-, opbouw-, pendel- en railtoepassingen.

Le **NEO** a un design cylindrique caractéristique et fait partie d'une famille complète pour diverses applications: encastré, apparent, suspendu ou sur rail 48V.

NEO IN



NEO POINT





NEO

ALGEMEEN / GÉNÉRALITÉS

TYPE inbouw plafond / encastrément plafond

MATERIAL aluminium

OPTION dimming: DALI

NEO IN

KENMERKEN / CARACTÉRISTIQUES

Type	W	CT	Lm	COLOUR	€ PRICE
M	16W	2700K 3000K	1109 1163	□ ■	225
L	20,1W	2700K 3000K	1476 1569	□ ■	225

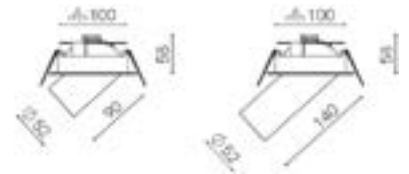

NEO POINT

KENMERKEN / CARACTÉRISTIQUES

Type	W	CT	Lm	COLOUR	€ PRICE
S	6,2W	2700K 3000K	390 411	□ ■	143
M	16W	2700K 3000K	1109 1163	□ ■	218
L	20,1W	2700K 3000K	1476 1569	□ ■	221
XL	32,5W	2700K 3000K	2432 2545	□ ■	285

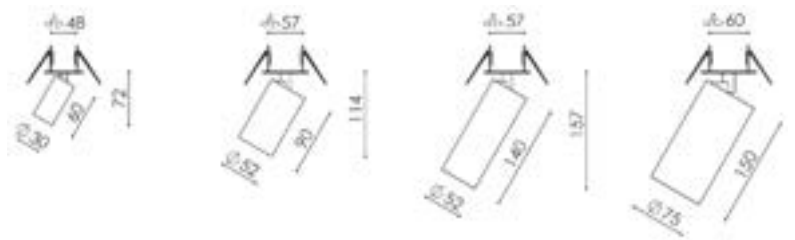

ACCESSOIRES

Inner ring - Gold

Inner ring - White

Honeycomb

Reflectors: 15° | 50°



27 FIT RECESSED

De **FIT RECESSED** is een inbouwspot, verkrijgbaar in dia 50 en 62 mm. Het toestel onderscheidt zich ondanks zijn cilindervormige geometrie en sobere vormgeving door zijn minimalisme en functionaliteit.

Le **FIT RECESSED** est un spot encastré, disponible en diamètres 50 et 62 mm. Malgré sa géométrie cylindrique et son design sobre, l'appareil se distingue par son minimalisme et sa fonctionnalité.

FIT RECESSED





FIT RECESSED

ALGEMEEN / GÉNÉRALITÉS

TYPE inbouw plafond / encastrément plafond

MATERIAL aluminium | polycarbonate

CT 2700K | 3000K | 4000K

OPTION dimming: DALI

Ø 50 mm

KENMERKEN / CARACTÉRISTIQUES

W	CT	Lm	COLOUR	€ PRICE
12W	2700K	1040	☐ ■	296
12W	3000K	1120	☐ ■	296
12W	4000K	1040	☐ ■	296



L80B10
>60.000h

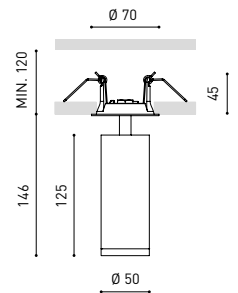

Ø 35 mm

KENMERKEN / CARACTÉRISTIQUES

W	CT	Lm	COLOUR	€ PRICE
5,5W	2700K	590	☐ ■	190
5,5W	3000K	630	☐ ■	190
5,5W	4000K	590	☐ ■	190



L80B10
>60.000h

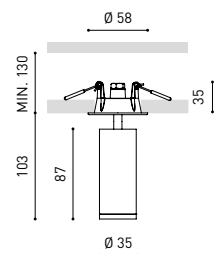



28 PLUS RECESSED

De **PLUS RECESSED** is een richtbare inbouwspot met verstelbare gradenbundel. Hierdoor is het toestel uitermate geschikt om kunstwerken of accent op de muur uit te lichten.

Le **PLUS RECESSED** est un projecteur encastré avec une ouverture du faisceau de lumière réglable. Cette fonctionnalité en fait un appareil particulièrement adapté pour l'éclairage des œuvres d'art ou pour mettre d'autres accents en valeur sur un mur.

PLUS RECESSED





PLUS RECESSED

ALGEMEEN / GÉNÉRALITÉS

TYPE inbouw plafond / encastrément plafond

MATERIAL aluminium

DIFFUSER optisch polymethylmethacrylaat / polyméthacrylate de méthyle optique

OPTION dimming: 1-10V | DALI | push

KENMERKEN / CARACTÉRISTIQUES

W	K	Lm	COLOUR	€ PRICE
18W	2700K	1920	☐ ■	342
18W	3000K	2000	☐ ■	342
18W	4000K	2030	☐ ■	342



L80B10
>60.000h

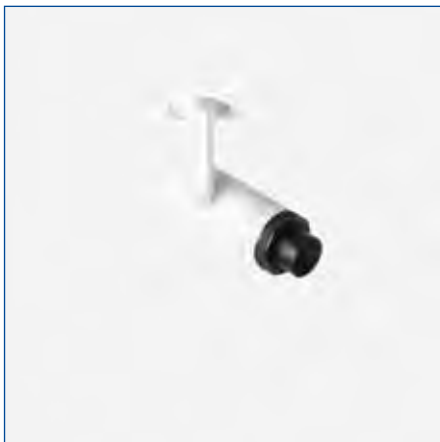
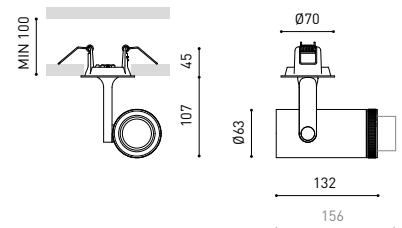

PLUS MINI RECESSED

ALGEMEEN / GÉNÉRALITÉS

TYPE inbouw plafond / encastrément plafond

MATERIAL aluminium

DIFFUSER optisch polymethylmethacrylaat / polyméthacrylate de méthyle optique

OPTION dimming: DALI

KENMERKEN / CARACTÉRISTIQUES

W	K	Lm	COLOUR	€ PRICE
6,5W	2700K	630	☐ ■	293
6,5W	3000K	660	☐ ■	293
6,5W	4000K	680	☐ ■	293



L80B10
>60.000h

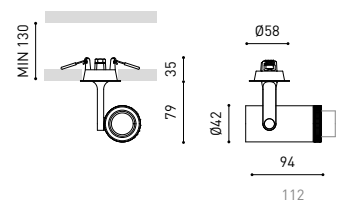



29 SUN LED

De **SUN LED** is een modern verlichtingstoestel met een hoge lichtefficiëntie en een lage verblindingsfactor.

Le **SUN LED** est un appareil d'éclairage moderne avec un rendement élevé et un facteur d'éblouissement faible.

SUN LED





SUN LED

ALGEMEEN / GÉNÉRALITÉS

TYPE inbouw plafond / encastrément plafond

MATERIAL staalplaat / tôle d'acier

DIFFUSER transparant MPRM / MPRM transparente

OPTION dimming: DALI

KENMERKEN / CARACTÉRISTIQUES

DIMENSIONS	W	CT	Lm	COLOUR	€ PRICE
600 x 600	30W	3000K	3610	☐	126
600 x 600	30W	4000K	3680	☐	126
300 x 1200	30W	3000K	3670	☐	128
300 x 1200	30W	4000K	3760	☐	128



L80B10
>72.000h

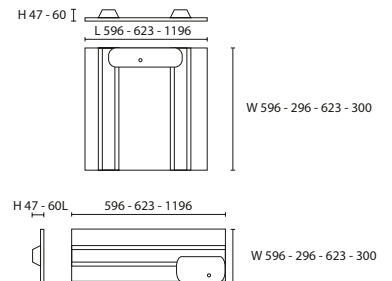

VARIATIES / VARIATIONS

Montage in pleisterplafonds / Montage dans plafond carton-plâtre



30 ELEMENT

NEW

De **ELEMENT** is de standaard ledtegel binnen ons gamma. Het toestel is optioneel DALI dimbaar of verkrijgbaar met niet-dimbare driver met aanpasbaar vermogen.

L' **ELEMENT** est la dalle LED standard de notre gamme. L'appareil est disponible en option avec un driver DALI dimmable ou avec un "multi-driver" non dimmable avec une puissance ajustable.



ELEMENT





ELEMENT

ALGEMEEN / GÉNÉRALITÉS

TYPE modulair plafond / plafond modulaire 600 x 600 mm

MATERIAL aluminium | polycarbonate

OPTION dimming: DALI | connector

KENMERKEN / CARACTÉRISTIQUES

DIMENSIONS	W	CT	Lm	COLOUR	€ PRICE
595 x 595	35W	3000K	3895	□	83
595 x 595	35W	4000K	4006	□	83
295 x 1195	35W	3000K	3704	□	91
295 x 1195	35W	4000K	3950	□	91



option

L90B10

>50.000h

ACCESSOIRES

Inbouwkader voor pleisterplafonds / Cadre encastré pour plafond carton-plâtre

Opbouwkader / Cadre apparent



31 PARABOLIC LED

De **PARABOLIC LED** is een 60x60 of 120x30 tegel die ook als opbouwtoestel verkrijgbaar is. Om verblinding zo veel mogelijk tegen te gaan maakt de PARABOLIC gebruik van een parabolische reflector om het licht te verspreiden. Dit zorgt ervoor dat het toestel erg geschikt is voor klaslokalen, kantoren, vergaderzalen, ... Kortom, op alle plaatsen waar gebruik gemaakt wordt van schermen.

Le **PARABOLIC LED** est une dalle 60x60 ou 120x30, également disponible en tant qu'appareil apparent. Pour réduire autant que possible l'éblouissement, le PARABOLIC LED est muni d'un réflecteur parabolique pour mieux diffuser la lumière. De ce fait, l'appareil est adapté aux salles de classe, bureaux, salles de réunion, ... En bref, dans tous les endroits où des écrans sont utilisés.



PARABOLIC LED



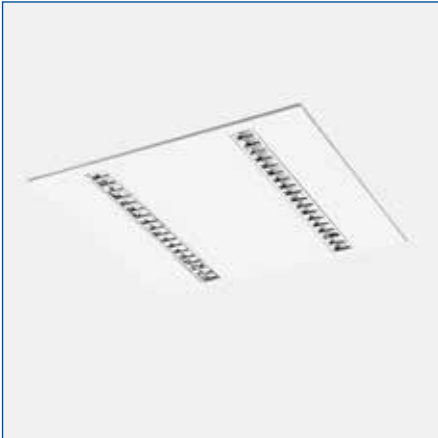

PARABOLIC LED

ALGEMEEN / GÉNÉRALITÉS

TYPE modulair plafond / plafond modulaire 600 x 600 mm

MATERIAL staalplaat / tôle d'acier

DIFFUSER parabolisch / parabolique

OPTION dimming: DALI

KENMERKEN / CARACTÉRISTIQUES

DIMENSIONS	W	CT	Lm	COLOUR	€ PRICE
300 x 1200	27W	3000K	3250	☐	146
300 x 1200	27W	4000K	3320	☐	146
600 x 600	27W	3000K	3250	☐	142
600 x 600	27W	4000K	3320	☐	142
600 x 600	40W	3000K	4880	☐	193
600 x 600	40W	4000K	4980	☐	193



L80B10
>72.000h

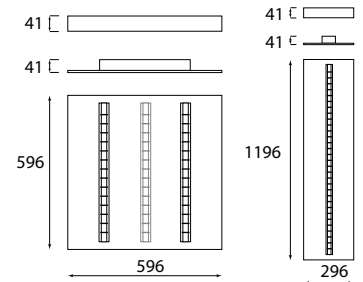

VARIATIES / VARIATIONS

Montage in pleisterplafonds / Montage dans plafond carton-plâtre



32 PARABOLIC SLIM LED

De **PARABOLIC SLIM LED** beschikt over gelijkaardige eigenschappen als de hiervoor genoemde Parabolic Led. Doordat de Parabolic Slim Led gebruik maakt van compactere LED-bronnen en dus ook kleinere wattages kan een minimalistisch design worden behouden.

Le **PARABOLIC SLIM LED** a des caractéristiques similaires au PARABOLIC LED mentionné ci-dessus. Du fait que le PARABOLIC SLIM LED utilise des sources LED plus compactes et donc aussi de plus petits wattages, un design minimaliste peut être maintenu.

PARABOLIC SLIM
LED





PARABOLIC SLIM LED

ALGEMEEN / GÉNÉRALITÉS

TYPE modulair plafond / plafond modulaire 600 x 600 mm

MATERIAL staalplaat / tôle d'acier

DIFFUSER parabolisch / parabolique

OPTION dimming: DALI

KENMERKEN / CARACTÉRISTIQUES

DIMENSIONS	W	CT	Lm	COLOUR	€ PRICE
600 x 600	28W	3000K	3190	☐	134
600 x 600	28W	4000K	3290	☐	134
600 x 600	37W	3000K	4300	☐	154
600 x 600	37W	4000K	4420	☐	154
300 x 1200	19W	3000K	2090	☐	114
300 x 1200	19W	4000K	2150	☐	114
300 x 1200	37W	3000K	4300	☐	158
300 x 1200	37W	4000K	4420	☐	158



option option option

L80B10
>72.000h

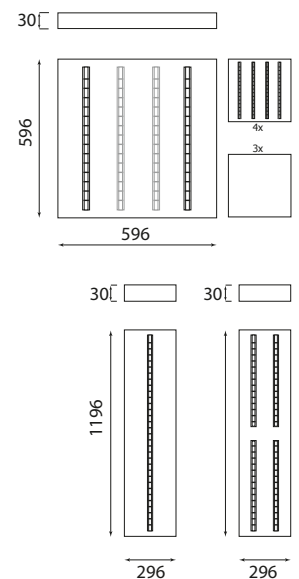

VARIATIES / VARIATIONS

Montage in pleisterplafonds / Montage dans plafond carton-plâtre

Witte parabolische diffuser / Diffuseur parabolique blanc



33 ROMA LED

NEW

ROMA LED is een armatuur die zich kenmerkt door hoge lichtparameters, een snelle installatie en een gelijkmatige verlichting op het oppervlak van de diffusor. Het toestel is ontworpen voor montage in plafonds 600 x 600 mm.

ROMA LED est un luminaire caractérisé par de bons paramètres d'éclairage, une installation rapide et un éclairage uniforme à la surface du diffuseur. Il est conçu pour être monté dans des plafonds de 600 x 600 mm.

ROMA LED



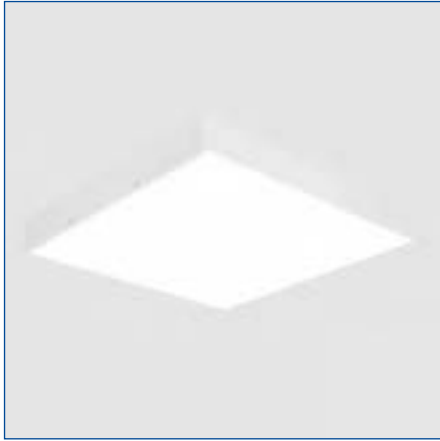

ROMA LED

ALGEMEEN / GÉNÉRALITÉS

TYPE	modulair plafond / plafond modulaire 600 x 600 mm
MATERIAL	gepoederlakte staalplaat / tôle d'acier peinte en poudre
DIFFUSER	OPAL MPRM option: MPRM
OPTION	dimming: DALI

KENMERKEN / CARACTÉRISTIQUES

DIMENSIONS	DIFFUSER	W	CT	Lm	COLOUR	€ PRICE
596 x 596	OPAL	24W	3000K	2640	☐	115
596 x 596	OPAL	24W	4000K	2700	☐	115
596 x 596	OPAL	38W	3000K	4370	☐	117
596 x 596	OPAL	38W	4000K	4460	☐	117
295 x 1195	OPAL	27W	3000K	2600	☐	157
295 x 1195	OPAL	27W	4000K	2650	☐	157
295 x 1195	OPAL	43W	3000K	4300	☐	159
295 x 1195	OPAL	43W	4000K	4390	☐	159
595 x 1195	OPAL	46W	3000K	6010	☐	238
595 x 1195	OPAL	46W	4000K	6130	☐	238
595 x 1195	OPAL	76W	3000K	9980	☐	252
595 x 1195	OPAL	76W	4000K	10190	☐	252
295 x 596	OPAL	16W	3000K	1210	☐	97
295 x 596	OPAL	16W	4000K	1230	☐	97
295 x 596	OPAL	24W	3000K	2010	☐	98
295 x 596	OPAL	24W	4000K	2050	☐	98



L80B10
>72.000h

H	W	L
595	595	90
295	1195	90
595	1195	90
295	596	90

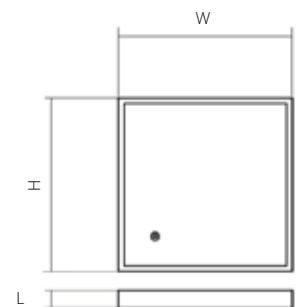

VARIATIES / VARIATIONS

Microprismatische diffuser MPRM / Diffuseur microprismatique MPRM

Noodunit geïntegreerd / Unité de secours intégré

Montage in pleisterplafond / Montage dans plafond carton-plâtre



34 ROMA CLEAN IP65

NEW

De **ROMA CLEAN IP65** is een 60x60 | 120x30 toestel specifiek ontworpen voor cleanrooms. Opvallend hierbij is een lichtopbrengst tot 11430Lm.

Le **ROMA CLEAN IP 65** est un appareil 60x60 / 120x30 spécialement conçu pour les salles blanches. Une caractéristique frappante ici est un rendement lumineux allant jusqu'à 11430 Lm.

ROMA CLEAN
IP65





ROMA CLEAN IP65

ALGEMEEN / GÉNÉRALITÉS

TYPE inbouw plafond / encastrément plafond

MATERIAL staalplaat / tôle d'acier

DIFFUSER opal | option: MPRM / PAR

OPTION dimming: DALI

KENMERKEN / CARACTÉRISTIQUES

DIMENSIONS	DIFFUSER	W	CT	Lm	COLOUR	€ PRICE
600 x 600	OPAL	43W	3000K	4950	☐	263
600 x 600	OPAL	43W	4000K	5100	☐	263
600 x 600	OPAL	100W	3000K	11430	☐	355
600 x 600	OPAL	100W	4000K	11430	☐	355
1200 x 300	OPAL	43W	3000K	4760	☐	270
1200 x 300	OPAL	43W	4000K	4910	☐	270
1200 x 600	OPAL	84W	3000K	9530	☐	452
1200 x 600	OPAL	84W	4000K	9820	☐	452



option option

L80B10
>72.000h

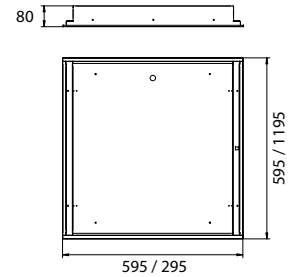

VARIATIES / VARIATIONS

Microprismatische MPRM of parabolische PAR diffuser / Diffuseur microprismatique MPRM ou parabolique PAR

Glazen diffuser SM MAT / Diffuseur en verre SM MAT



35 SPORT LED

De **SPORT LED** is bestemd voor het gebruik in sportzalen waar een risico bestaat op de impact van een bal. Het toestel is geschikt voor tegelplafonds maar ook is de **SPORT LED** beschikbaar met bevestigingen voor gyprocplafonds. Alle toestellen zijn gemaakt uit 0,5 mm dik staal en zijn uitgerust met een beschermingsgrille. Als optie kan een polycarbonaat plexi, aluminium grille of een gepolierde MIRO reflector geplaatst worden om een betere efficiëntie te behalen. Louvre-versie: wordt versterkt met 3 stalen draden in een witte kleur. De **GRID**-uitvoering beschikt over dezelfde eigenschappen als de **LOUVRE**. Daarnaast is deze versterkt met een extra rooster bovenop de (aluminium) reflector.

Ces luminaires sont destinés à l'usage dans les salles de sport avec un risque de choc à causer par des ballons. Les luminaires sont destinés au montage dans les plafonds modulaires type M600 et pour ouvertures de plafond découpées. Luminaires utilisant la source avancée type LED. Equipé de sources lumineuses led d'Osram, Philips ou Samsung selon les disponibilités. Tous les appareils **SPORT LED** sont fabriqués à partir d'acier de 0,5 mm d'épaisseur et équipés d'une grille de protection. En option, un plexi en polycarbonate, une grille en aluminium ou un réflecteur MIRO poli peuvent être utilisés afin d'obtenir une meilleure efficacité. La version « **GRID** » présente les mêmes caractéristiques que la version « **LOUVRE** ». En outre, celle-ci est renforcée avec une grille supplémentaire par-dessus le réflecteur (en aluminium).



SPORT LOUVRE



SPORT GRID





SPORT LED

ALGEMEEN / GÉNÉRALITÉS

TYPE	inbouw plafond / encastrément plafond
MATERIAL	staalplaat / tôle d'acier
CT	3000K op aanvraag / sur demande
OPTION	dimming: DALI - noodverlichting / éclairage de secours

SPORT LOUVRE 4G

KENMERKEN / CARACTÉRISTIQUES

DIMENSIONS	W	CT	Lm	COLOUR	€ PRICE
595x595x85	47W	4000K	5974	<input type="checkbox"/>	358
595x595x85	95W	4000K	11590	<input type="checkbox"/>	363
295x1195x85	47W	4000K	6018	<input type="checkbox"/>	358
295x1195x85	95W	4000K	11590	<input type="checkbox"/>	363
595x1195x85	132W	4000K	16368	<input type="checkbox"/>	580
595x1195x85	190W	4000K	22040	<input type="checkbox"/>	613
295x1495x85	70W	4000K	9662	<input type="checkbox"/>	394
295x1495x85	102W	4000K	13496	<input type="checkbox"/>	394
295x1495x85	142W	4000K	17986	<input type="checkbox"/>	403



SPORT GRID

KENMERKEN / CARACTÉRISTIQUES

DIMENSIONS	W	K	Lm	COLOUR	€ PRICE
595x595x85	47W	4000K	6125	<input type="checkbox"/>	388
595x595x85	95W	4000K	12495	<input type="checkbox"/>	394
295x1195x85	47W	4000K	6125	<input type="checkbox"/>	388
295x1195x85	95W	4000K	12495	<input type="checkbox"/>	394
595x1195x85	132W	4000K	16630	<input type="checkbox"/>	672
595x1195x85	190W	4000K	24453	<input type="checkbox"/>	676
295x1495x85	70W	4000K	9075	<input type="checkbox"/>	430
295x1495x85	102W	4000K	12840	<input type="checkbox"/>	430
295x1495x85	142W	4000K	16934	<input type="checkbox"/>	445



L90B20
>50.000h

VARIATIES / VARIATIONS

Opbouw montage / Montage apparent



36 SQUARE LED

De **SQUARE LED** is een hoogwaardig LED-armatuur die een subtiel en gelijkmatig licht uitstraalt, diffuus over de contouren van de armatuur. Het toestel beschikt over een opaal glas met centraal gemonteerd plafondpaneel, harmonieus geïntegreerd in tegelplafonds 600 x 600. Let op: het centraal gemonteerd plafondpaneel maakt geen deel uit van het toestel.

Luminaire LED de qualité supérieure, émettant une lumière subtile et uniforme, diffuse sur le contour du luminaire. Luminaire avec glace opalisée et panneau de plafond placé centralement, harmonieusement intégré à la surface de plafond 600 x 600. Remarque: le panneau de plafond placé centralement ne fait pas partie d'un luminaire.

SQUARE LED



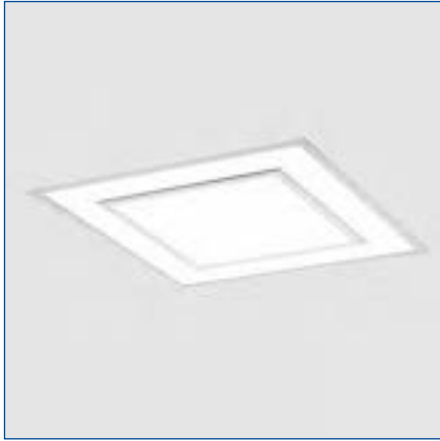

SQUARE LED

ALGEMEEN / GÉNÉRALITÉS

TYPE modulaire plafond 600 x 600 mm | gipskartonplafond /
plafond modulaire 600 x 600 mm | plafond en gyproc

MATERIAL staalplaat / tôle d'acier

DIFUSSER OPAL

OPTION dimming: DALI - noodverlichting / éclairage de secours

KENMERKEN / CARACTÉRISTIQUES

DIMENSIONS	W	CT	Lm	COLOUR	€ PRICE
595 x 595	38W	3000K	4280	□	211
595 x 595	38W	4000K	4370	□	211



L80B10
>72.000h

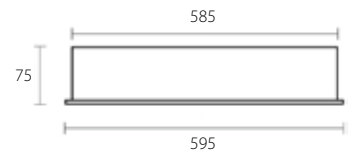

VARIATIES / VARIATIONS

Opbouwmontage / Montage apparent

37 SIMPLE ARC LED

De **SIMPLE ARC** is een modulair toestel, geschikt voor plaatsing in tegelplafonds. Waar een tegelplafond doorgaans sober is laat de combinatie van rechte stukken en 90° bochten een creatieve interpretatie toe om het geheel een modern en speels karakter mee te geven.

Le **SIMPLE ARC** est un appareil modulaire, adapté à l'installation dans des plafonds en dalles. Là où un plafond à dalles est généralement sobre, la combinaison de pièces droites et à 90° permet une interprétation créative pour donner à l'ensemble un caractère moderne et ludique.

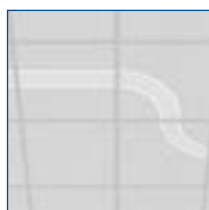

SIMPLE ARC LED

ALGEMEEN / GÉNÉRALITÉS

TYPE modulair plafond 600 x 600 / plafond modulaire 600 x 600

MATERIAL gepoederlakte staalplaat / tôle d'acier

DIFUSSER OPAL

OPTION dimming: DALI

KENMERKEN / CARACTÉRISTIQUES

W	CT	Lm	COLOUR	€ PRICE
14W	3000K	1220	☐	137
14W	4000K	1260	☐	137



L80B10
>72.000h

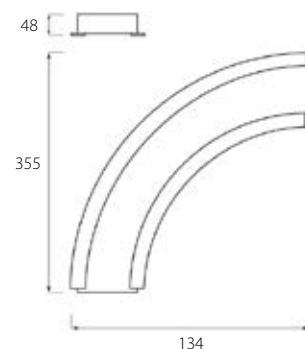

SIMPLE ARC LED



De vermelde prijzen zijn indicatieve brutoprijzen zonder mogelijke opties of meerprijzen.
Deze zijn bedoeld om een vlugge budgettering te kunnen maken of te kunnen inschatten in welke prijsrichting het artikel zich bevindt.
Voor een nauwkeurige prijsofferte/ev. lichtstudie staat ons team ter uwer beschikking.

Les prix indiqués sont des prix bruts indicatifs sans les options possibles ou suppléments de prix.
Le but étant de pouvoir faire une budgétisation rapide ou d'estimer dans quelle échelle de prix l'article se situe.
Notre équipe est à votre disposition pour une offre de prix précise ou une éventuelle étude d'éclairage.

DOWNLIGHTS | SPOTS
OPBOUW | APPARENT



1 BARI ECO DLN LED

Moderne en universele LED-downlight voor kantoren, hotels, restaurants, zalen, winkelcentra, ...

Downlight LED moderne et universel. Application: bureaux, hôtels, restaurants, halls, centres commerciaux, ...

BARI ECO DLN
LED





BARI ECO DLN LED

ALGEMEEN / GÉNÉRALITÉS

TYPE opbouw plafond / apparent plafond

MATERIAL aluminium

OPTION dimming: DALI

KENMERKEN / CARACTÉRISTIQUES

W	CT	Lm	COLOUR	€ PRICE
10W	3000K 4000K	1140 1160	<input type="checkbox"/> <input checked="" type="checkbox"/>	129
15W	3000K 4000K	1560 1590	<input type="checkbox"/> <input checked="" type="checkbox"/>	136
19W	3000K 4000K	1990 2030	<input type="checkbox"/> <input checked="" type="checkbox"/>	136
28W	3000K 4000K	2690 2750	<input type="checkbox"/> <input checked="" type="checkbox"/>	136



L80B10
>72.000h

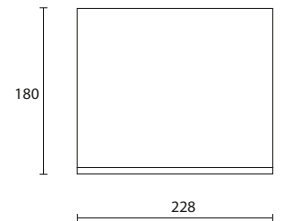

BARI ECO DLN IP65 LED

ALGEMEEN / GÉNÉRALITÉS

TYPE opbouw plafond / apparent plafond

MATERIAL aluminium

OPTION dimming: DALI

KENMERKEN / CARACTÉRISTIQUES

W	CT	Lm	COLOUR	€ PRICE
10W	3000K 4000K	1140 1160	<input type="checkbox"/>	169
15W	3000K 4000K	1560 1590	<input type="checkbox"/>	176
19W	3000K 4000K	1990 2030	<input type="checkbox"/>	176
28W	3000K 4000K	2690 2750	<input type="checkbox"/>	176



L80B10
>72.000h

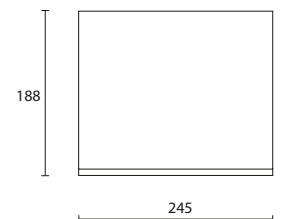



2 PUCK

De **PUCK** is een vast opbouwtoestel, vervaardigd uit aluminium. Door het gebruik van de lens wordt het licht egaal verspreid. Gezien de lumenoutput is de PUCK het perfecte alternatief op plaatsen waar een standaard inbouwspot niet kan geplaatst worden.

Le **PUCK** est un appareil apparent fixe en aluminium. Grâce à l'utilisation d'une lentille, la lumière est répartie égale. Compte tenu de son efficacité, le PUCK est l'alternative parfaite aux endroits où un downlight standard ne peut pas être placé.



PUCK



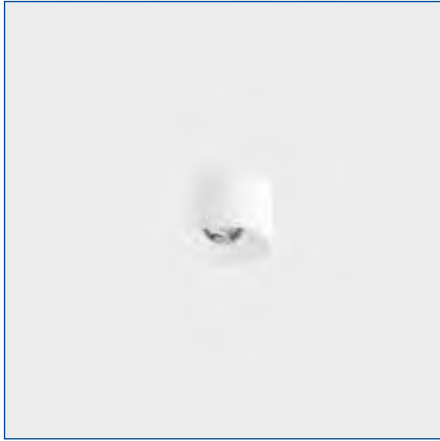

PUCK S

ALGEMEEN / GÉNÉRALITÉS

TYPE opbouw plafond / apparent plafond

MATERIAL aluminium | optical glass

OPTION afwerking in koper- en goudkleur / finition cuivre et or

KENMERKEN / CARACTÉRISTIQUES

W	CT	Lm	COLOUR	€ PRICE
8W	2700K	600	□ ■ ■ ■	153
8W	3000K	640	□ ■ ■ ■	153
8W	4000K	670	□ ■ ■ ■	153



L70B50
>36.000h

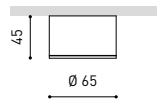

PUCK M

KENMERKEN / CARACTÉRISTIQUES

W	CT	Lm	COLOUR	€ PRICE
12W	2700K	960	□ ■ ■ ■	188
12W	3000K	1020	□ ■ ■ ■	188
12W	4000K	1080	□ ■ ■ ■	188



L70B50
>36.000h

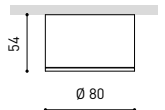

PUCK L

KENMERKEN / CARACTÉRISTIQUES

W	CT	Lm	COLOUR	€ PRICE
20W	2700K	1500	□ ■ ■ ■	215
20W	3000K	1600	□ ■ ■ ■	215
20W	4000K	1660	□ ■ ■ ■	215



L70B50
>36.000h

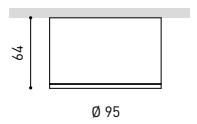
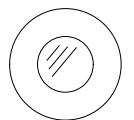







3 STRAM SURFACE

De **STRAM SURFACE** is een opbouw downlight met dezelfde karakteristieken als de STRAM voor ruimtes waar het onmogelijk is om in het plafond te bouwen. De opstaande rand zorgt voor een herkenbaar en onderscheidend design

Le **STRAM SURFACE** est un downlight apparent qui conserve l'esthétique et les effets lumineux du STRAM dans des espaces où il est impossible d'encastrer dans le plafond. La particularité de sa collerette en fait un luminaire offrant des flux lumineux élevés tout en restant élégant.



STRAM SURFACE





STRAM SURFACE

ALGEMEEN / GÉNÉRALITÉS

TYPE opbouw plafond / apparent plafond

MATERIAL aluminium | polymethyl methacrylate

OPTION dimming: push | 1-10V | DALI

KENMERKEN / CARACTÉRISTIQUES

W	CT	Lm	COLOUR	€ PRICE
10,5W	2700K	1525	☐ ■	242
10,5W	3000K	1650	☐ ■	242
10,5W	4000K	1675	☐ ■	242
15,5W	2700K	2100	☐ ■	246
15,5W	3000K	2275	☐ ■	246
15,5W	4000K	2300	☐ ■	246
22W	2700K	2800	☐ ■	263
22W	3000K	3025	☐ ■	263
22W	4000K	3075	☐ ■	263



L80B10
>60.000h

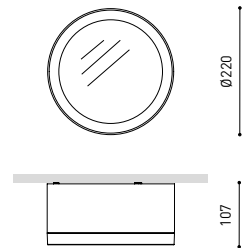

STRAM SURFACE MINI

ALGEMEEN / GÉNÉRALITÉS

TYPE opbouw plafond / apparent plafond

MATERIAL aluminium | polymethyl methacrylate

OPTION dimming: phase cut

KENMERKEN / CARACTÉRISTIQUES

W	CT	Lm	COLOUR	€ PRICE
7W	2700K	975	☐ ■	167
7W	3000K	1050	☐ ■	167
7W	4000K	1075	☐ ■	167
10W	2700K	1275	☐ ■	183
10W	3000K	1375	☐ ■	183
10W	4000K	1400	☐ ■	183



L80B10
>60.000h

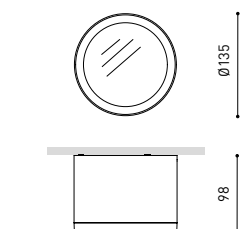



4 TOP

De **TOP** is een eenvoudige opbouwspot die accenten legt in het interieur. De minimale afmetingen en het design zorgen voor rust op plaatsen waar dat gewenst is.

Le **TOP** est un spot apparent qui donne des accents de lumière à l'intérieur. Ses dimensions miniatures et son design donnent une certaine présence discrète dans les endroits souhaités.





TOP

ALGEMEEN / GÉNÉRALITÉS

TYPE opbouw plafond / apparent plafond

MATERIAL aluminium | polycarbonate

KENMERKEN / CARACTÉRISTIQUES

W	CT	I	Lm		COLOUR	€ PRICE
4,5W	2700K	500mA	480	20° 30° 56°	<input type="checkbox"/> <input checked="" type="checkbox"/>	132
4,5W	3000K	500mA	500	20° 30° 56°	<input type="checkbox"/> <input checked="" type="checkbox"/>	132
4,5W	4000K	500mA	515	20° 30° 56°	<input type="checkbox"/> <input checked="" type="checkbox"/>	132



L80B10
>60.000h

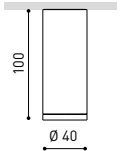

TOP MINI

ALGEMEEN / GÉNÉRALITÉS

TYPE opbouw plafond / apparent plafond (remote driver)

MATERIAL aluminium | polycarbonate

OPTION dimming: Push | 1-10V | DALI

KENMERKEN / CARACTÉRISTIQUES

W	CT	Lm		COLOUR	€ PRICE
4,5W	2700K	480	20° 30° 56°	<input type="checkbox"/> <input checked="" type="checkbox"/>	90
4,5W	3000K	500	20° 30° 56°	<input type="checkbox"/> <input checked="" type="checkbox"/>	90
4,5W	4000K	515	20° 30° 56°	<input type="checkbox"/> <input checked="" type="checkbox"/>	90
6,5W	2700K	610	20° 30° 56°	<input type="checkbox"/> <input checked="" type="checkbox"/>	90
6,5W	3000K	640	20° 30° 56°	<input type="checkbox"/> <input checked="" type="checkbox"/>	90
6,5W	4000K	655	20° 30° 56°	<input type="checkbox"/> <input checked="" type="checkbox"/>	90



L80B10
>60.000h

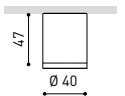

ACCESSOIRES



HIGH CHROMATIC LED



BEAM MIXER DIFFUSER



ANTI-GLARE HONEYCOMB LOUVER



DRIVER OPTIONS

DRIVER OPTIONS

		P	€ PRICE
no dim	1-4 Top Mini	4,5W	53
no dim	1-4 Top Mini	6,5W	53
push 1-10V	1-4 Top Mini	4,5W	90
push 1-10V	1-4 Top Mini	6,5W	90
DALI	1-4 Top Mini	4,5W	107
DALI	1-4 Top Mini	6,5W	107



5 NEO ON

NEW

De **NEO** heeft een herkenbaar cilindervormig design en maakt deel uit van een volledige familie voor inbouw-, opbouw-, pendel- en railtoepassingen.

Le **NEO ON** a un design cylindrique caractéristique et fait partie d'une famille complète pour applications encastrées, apparentes, suspendues ou sur rail.

NEO ON





NEO ON

ALGEMEEN / GÉNÉRALITÉS

TYPE opbouw plafond / encastrément plafond

MATERIAL aluminium

OPTION dimming: DALI

KENMERKEN / CARACTÉRISTIQUES

Type	W	CT	Lm	COLOUR	€ PRICE
M	16,2W	2700K	1109	☐ ■	173
M	16,2W	3000K	1163	☐ ■	173
L	20,1W	2700K	1476	☐ ■	158
L	20,3W	3000K	1569	☐ ■	158
XL	32,5W	2700K	2432	☐ ■	248
XL	32,5W	3000K	2545	☐ ■	248

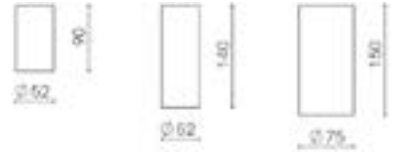

ACCESSOIRES

Inner ring - Gold

Inner ring - White

Honeycomb

reflectors: 15° | 50°







6 BLACK FOSTER SURFACE

De **BLACK FOSTER SURFACE** is een lineair opbouwtoestel die de "invisible black" eigenschappen deelt met de Shot Light familie (pagina 60). Dit effect wordt verkregen doordat de behuizing de dieperliggende ledbron zo onzichtbaar mogelijk maakt. Hiervoor is de BLACK FOSTER uitgerust met een anti-verblindend oppervlak en speciaal ontworpen micro-reflector die de lichtstralen perfect geleid zonder dat deze de zijkanten raken. De BLACK FOSTER is ook verkrijgbaar als inbouw- en trimlessversie (zie pagina 64).

Le **BLACK FOSTER SURFACE** est un appareil linéaire apparent qui partage les propriétés de l'«invisible black» avec la famille d'appareils Shot light (page 60). Cet effet est obtenu grâce au corps de l'appareil ou la source LED est implantée le plus profondément possible ; ce qui rend donc cette dernière invisible. Pour cela, le BLACK FOSTER est équipé d'une surface anti-éblouissement et d'un micro-réflecteur spécialement conçu pour guider parfaitement les rayons lumineux sans qu'ils n'heurtent les côtés. Le BLACK FOSTER est également disponible en version encastré et trimless (voir page 64).



BLACK FOSTER
SURFACE





BLACK FOSTER HL Surface 1

ALGEMEEN / GÉNÉRALITÉS

TYPE opbouw plafond / apparent plafond

MATERIAL aluminium

OPTION dimming: push | DALI

KENMERKEN / CARACTÉRISTIQUES

W	K	Lm	COLOUR	€ PRICE
2,1W	2700K	190		213
2,1W	3000K	210		213
2,1W	4000K	250		213



L90B10
>102.000h

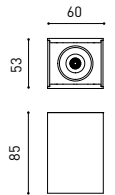

BLACK FOSTER HL Surface 2

KENMERKEN / CARACTÉRISTIQUES

W	K	Lm	COLOUR	€ PRICE
4,2W	2700K	380		296
4,2W	3000K	420		296
4,2W	4000K	500		296



L90B10
>102.000h

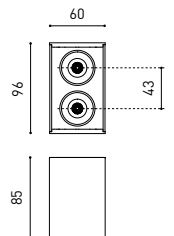

BLACK FOSTER HL Surface 3

KENMERKEN / CARACTÉRISTIQUES

W	K	Lm	COLOUR	€ PRICE
6,3W	2700K	570		333
6,3W	3000K	630		333
6,3W	4000K	750		333



L90B10
>102.000h

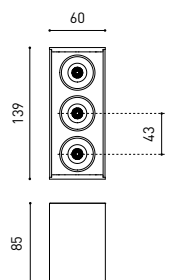



BLACK FOSTER HL Surface 5

KENMERKEN / CARACTÉRISTIQUES

W	K	Lm	COLOUR	€ PRICE
10,5W	2700K	950	☐ ■ ▨ ▩	339
10,5W	3000K	1050	☐ ■ ▨ ▩	339
10,5W	4000K	1250	☐ ■ ▨ ▩	339



L90B10
>102.000h



BLACK FOSTER HL Surface 10

KENMERKEN / CARACTÉRISTIQUES

W	K	Lm	COLOUR	€ PRICE
21W	2700K	1900	☐ ■ ▨ ▩	501
21W	3000K	2100	☐ ■ ▨ ▩	501
21W	4000K	2500	☐ ■ ▨ ▩	501



L90B10
>102.000h



BLACK FOSTER HL Surface 15

KENMERKEN / CARACTÉRISTIQUES

W	K	Lm	COLOUR	€ PRICE
31,5W	2700K	2850	☐ ■ ▨ ▩	663
31,5W	3000K	3150	☐ ■ ▨ ▩	663
31,5W	4000K	3750	☐ ■ ▨ ▩	663



L90B10
>102.000h

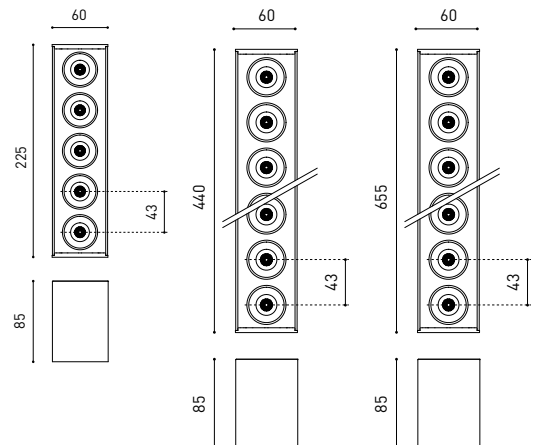





7 CAJA

De **CAJA** is een elegant en verfijnd toestel vervaardigd uit aluminium. Door de richtbare spots en de dimbare driver leent de CAJA zich perfect tot het belichten van accenten.

Le **CAJA** est un appareil élégant et raffiné en aluminium. Grâce à ses spots réglables et au driver dimmable, le CAJA se prête parfaitement aux éclairages d'accentuation.

CAJA



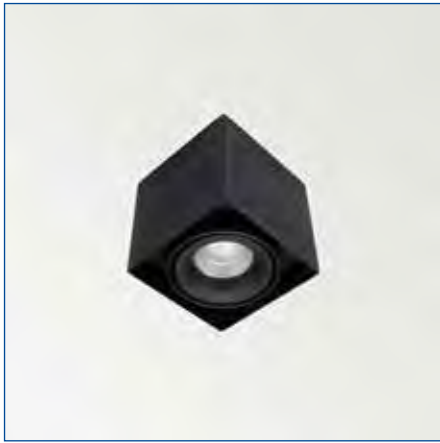

CAJA 1

ALGEMEEN / GÉNÉRALITÉS

TYPE opbouw plafond / apparent plafond

MATERIAL aluminium

STANDARD dimming: phase cut

KENMERKEN / CARACTÉRISTIQUES

W	K	Lm	COLOUR	€ PRICE
10W	2700K	660	□ ■ ■	113
10W	3000K	700	□ ■ ■	113
10W	4000K	850	□ ■ ■	113



L80B10
>50.000h

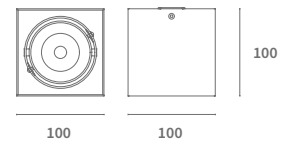

CAJA 2

KENMERKEN / CARACTÉRISTIQUES

W	K	Lm	COLOUR	€ PRICE
20W	2700K	1320	□ ■ ■	189
20W	3000K	1400	□ ■ ■	189
20W	4000K	1700	□ ■ ■	189



L80B10
>50.000h

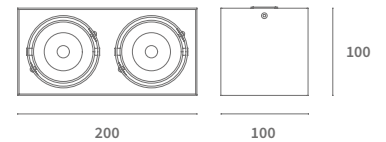



8 iO SURFACE

De **iO SURFACE** is een heel compacte opbouw LED-spot, niet hoger dan 5 cm. Het toestel is ontworpen als accentverlichting en komt vooral in een meer residentiële sfeer en verfijnde retail omgeving perfect tot zijn recht. Ook kan de iO eventueel in combinatie met andere spots op een railsysteem gemonteerd worden.

L'**iO SURFACE** est un spot LED apparent extrêmement compact, pas plus haut que 5 cm. L'iO a été conçu comme éclairage d'accentuation et est particulièrement apprécié dans une atmosphère plus résidentielle ou dans un commerce de détail raffiné. L'iO peut éventuellement aussi être monté sur un système de rail en combinaison avec d'autres spots.



iO SURFACE





iO SURFACE

ALGEMEEN / GÉNÉRALITÉS

TYPE opbouw plafond / apparent plafond

MATERIAL aluminium | polycarbonate

KENMERKEN / CARACTÉRISTIQUES

W	CT	Lm	COLOUR	€ PRICE
4,5W	2700K	485	☐ ■	144
4,5W	3000K	505	☐ ■	144
4,5W	4000K	520	☐ ■	144



355° 20-30-56°

L90B10
>55.000h

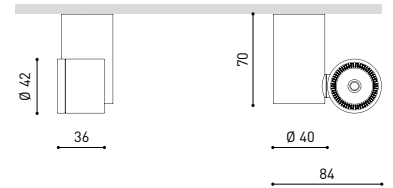

ACCESSOIRES



HIGH CHROMATIC LED



BEAM MIXER DIFFUSER



ANTI-GLARE HONEYCOMB LOUVER





9 FLO Q | FLO T

De **FLO** is een strak design opbouwtoestel geschikt voor wand en plafondmontage. De behuizing is vervaardigd uit aluminium in diverse afwerkingskleuren met een krasbestendige opaal polycarbonaat diffusor. Het PMMA LGP-paneel zorgt voor een homogene lichtverspreiding zonder zichtbare leds. De FLO is daarnaast verkrijgbaar met noodunit wat deze erg geschikt maakt voor toepassingen in gangen en traphallen.

Le **FLO** est un appareil apparent, au design élégant, adapté au montage mural et au plafond. Le boîtier est en aluminium, dans différentes couleurs de finition, avec un diffuseur en polycarbonate opalin résistant aux rayures. Le panneau PMMA LGP assure une distribution lumineuse homogène sans LED visibles. Le FLO est également disponible avec une unité de secours, ce qui le rend particulièrement utile pour une installation dans des couloirs ou cages d'escalier.

FLO



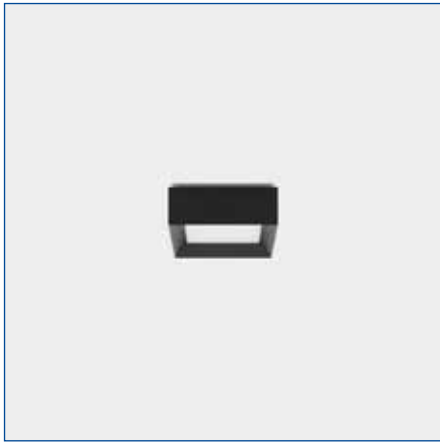

FLO Q 150

ALGEMEEN / GÉNÉRALITÉS

TYPE opbouw plafond, wand / apparent plafond, mur

MATERIAL geëxtrudeerd aluminium / aluminium extrudé

DIFFUSER opaal polycarbonaat / polycarbonate opal

OPTION dimming: 1-10V | DALI | push

KENMERKEN / CARACTÉRISTIQUES

W	CT	Lm	COLOUR	€ PRICE
10W	2700K	434	□ ■ ● ●	127
10W	3000K	456	□ ■ ● ●	127
10W	4000K	481	□ ■ ● ●	127



L80B20
>50.000h

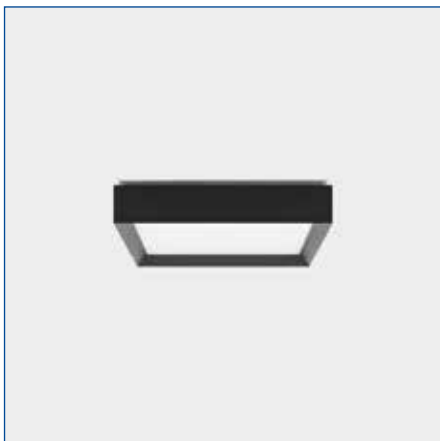

FLO Q 300

ALGEMEEN / GÉNÉRALITÉS

TYPE opbouw plafond, wand / apparent plafond, mur

MATERIAL geëxtrudeerd aluminium / aluminium extrudé

DIFFUSER opaal polycarbonaat / polycarbonate opal

OPTION dimming: 1-10V | DALI | push

KENMERKEN / CARACTÉRISTIQUES

W	CT	Lm	COLOUR	€ PRICE
30W	2700K	1957	□ ■ ● ●	207
30W	3000K	2060	□ ■ ● ●	207
30W	4000K	2169	□ ■ ● ●	207



L80B20
>50.000h

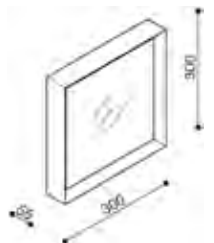

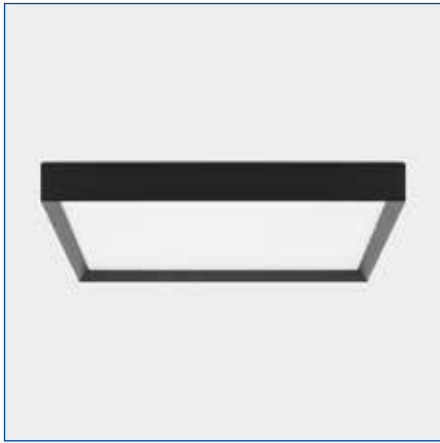

FLO Q 500

ALGEMEEN / GÉNÉRALITÉS

TYPE opbouw plafond, wand / apparent plafond, mur

MATERIAL geëxtrudeerd aluminium / aluminium extrudé

DIFFUSER opaal polycarbonaat / polycarbonate opal

OPTION dimming: 1-10V | DALI | push

KENMERKEN / CARACTÉRISTIQUES

W	CT	Lm	COLOUR	€ PRICE
39W	2700K	2930	□ ■ ● ●	353
39W	3000K	3084	□ ■ ● ●	353
39W	4000K	3247	□ ■ ● ●	353



L80B20
>50.000h

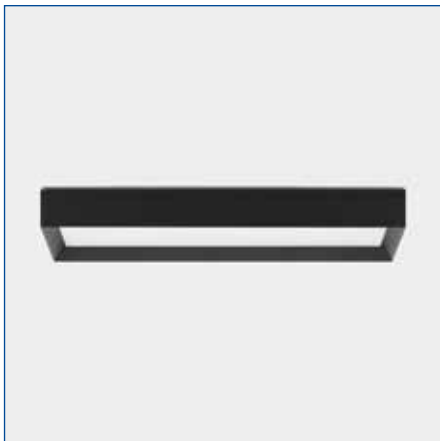
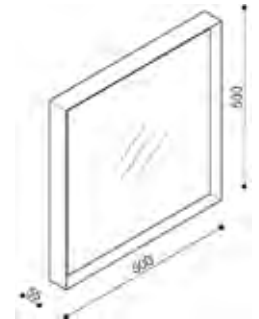

FLO R

ALGEMEEN / GÉNÉRALITÉS

TYPE opbouw plafond, wand / apparent plafond, mur

MATERIAL geëxtrudeerd aluminium / aluminium extrudé

DIFFUSER opaal polycarbonaat / polycarbonate opal

OPTION dimming: 1-10V | DALI | push

KENMERKEN / CARACTÉRISTIQUES

W	CT	Lm	COLOUR	€ PRICE
39W	2700K	1971	□ ■ ● ●	240
39W	3000K	2074	□ ■ ● ●	240
39W	4000K	2184	□ ■ ● ●	240



L80B20
>50.000h

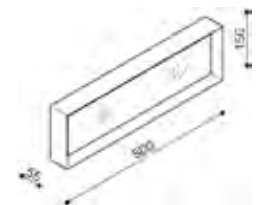



FLO T 300

ALGEMEEN / GÉNÉRALITÉS

TYPE opbouw plafond, wand / apparent plafond, mur

MATERIAL aluminium

DIFFUSER polycarbonaat / polycarbonate

OPTION dimming: 1-10V | DALI | push

KENMERKEN / CARACTÉRISTIQUES

W	CT	Lm	COLOUR	€ PRICE
30W	2700K	1927	□ ■ ● ●	207
30W	3000K	2029	□ ■ ● ●	207
30W	4000K	2136	□ ■ ● ●	207



option option option

L80B20
>50.000h



FLO T 500

KENMERKEN / CARACTÉRISTIQUES

W	CT	Lm	COLOUR	€ PRICE
39W	2700K	3174	□ ■ ● ●	353
39W	3000K	3341	□ ■ ● ●	353
39W	4000K	3517	□ ■ ● ●	353



option option option

L80B20
>50.000h





10 FINESTRA RING LED

De **FINESTRA RING LED** is de ronde versie van de FINESTRA, verkrijgbaar in een diameter tot 1065 mm. Ook hier wordt het toestel vaak toegepast in winkelcentra, hotels, zalen, etc. In tegenstelling tot de vierkante Finestra is de ringversie niet verkrijgbaar met een IP44 beschermingsgraad.

UPDATE

Le **FINESTRA RING LED** est la version ronde du FINESTRA, disponible dans des diamètres allant jusqu'à 1065 mm. Ici aussi, l'appareil est souvent utilisé dans les centres commerciaux, les hôtels, les salles, etc. Contrairement au Finestra carré, la version ronde n'est pas disponible avec un degré de protection IP44.

FINESTRA RING



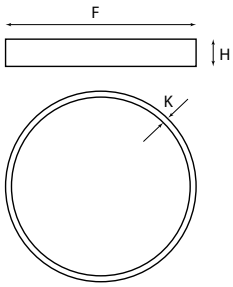

H	F	K
66	320	13
66	440	13
66	520	13
110	630	13
110	800	13
110	1065	13

FINESTRA RING LED

ALGEMEEN / GÉNÉRALITÉS

TYPE opbouw, pendel / apparent, suspendu

MATERIAL aluminium

DIFFUSER OPAL | option: microprismatisch / microprismatique MPRM

OPTION dimming: DALI

KENMERKEN / CARACTÉRISTIQUES

DIMENSIONS	W	CT	Lm	COLOUR	€ PRICE
Ø 320 x h 66	16W	3000K 4000K	1700 1750	☐ ■ ●	166
Ø 440 x h 66	37W	3000K 4000K	3760 3870	☐ ■ ●	208
Ø 520 x h 66	37W	3000K 4000K	4150 4400	☐ ■ ●	282
Ø 630 x h 110	37W	3000K 4000K	4150 4400	☐ ■ ●	284
Ø 800 x h 110	57W	3000K 4000K	6180 6370	☐ ■ ●	374
Ø 1065 x h 110	100W	3000K 4000K	11880 12250	☐ ■ ●	573



L80B10
>72.000h

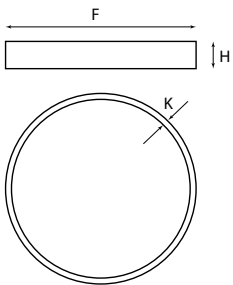
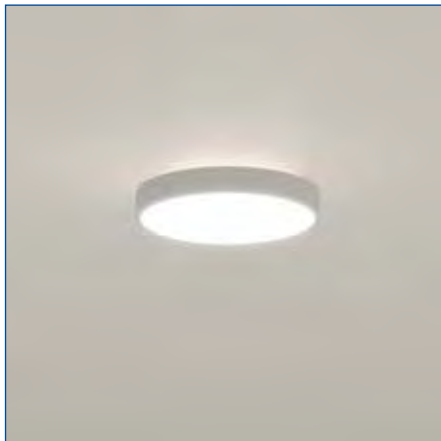

H	F	K
66	320	13
66	440	13
66	520	13
110	630	13
110	800	13
110	1065	13

FINESTRA RING GLOW LED

ALGEMEEN / GÉNÉRALITÉS

TYPE opbouw / apparent

MATERIAL aluminium

DIFFUSER OPAL | option: microprismatisch / microprismatique MPRM

OPTION dimming: DALI

KENMERKEN / CARACTÉRISTIQUES

DIMENSIONS	W	CT	Lm	COLOUR	€ PRICE
Ø 440 x h 80	43W	3000K 4000K	4130 4245	☐ ■ ●	396
Ø 520 x h 80	43W	3000K 4000K	4400 34525	☐ ■ ●	505
Ø 630 x h 124	47W	3000K 4000K	5025 5165	☐ ■ ●	570
Ø 800 x h 124	70W	3000K 4000K	6960 7100	☐ ■ ●	645



L80B10
>72.000h

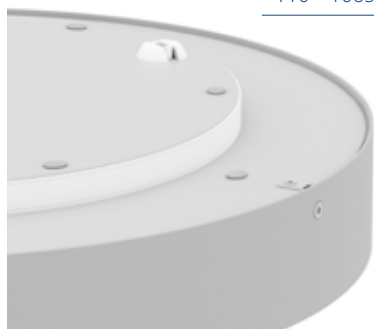

ACCESSOIRES

Electrical suspension | Grey, White

Recessed frame Finestra Ring

Finestra Ring 3x Suspension set | 1500, 3000 mm | Grey

Simple suspension



11 FINESTRA Q LED

NEW

De **FINESTRA Q LED** is een decoratief opbouwtoestel met een moderne en elegante afwerking. Het toestel is door zijn universele, sobere vormgeving en type montage zeer breed toepasbaar.

Le **FINESTRA Q LED** est un appareil décoratif apparent avec une finition moderne et élégante. En raison de sa conception universelle, sobre, et de son type de montage, l'appareil convient pour de nombreuses applications.

FINESTRA Q LED





FINESTRA Q LED

ALGEMEEN / GÉNÉRALITÉS

TYPE opbouw muur, plafond | pendel / apparent mur, plafond | suspendu

MATERIAL gepoederlakte staalplaat / tôle d'acier peinte en poudre

DIFFUSER OPAL

FINESTRA Q LED

KENMERKEN / CARACTÉRISTIQUES

Dimensions	W	CT	Lm	€ PRICE
307x307	18W	3000K 4000K	1960 2020	85
407x407	23W	3000K 4000K	2760 2850	99
595x295	28W	3000K 4000K	3310 3420	104
595x295	36W	3000K 4000K	4250 4380	122



option option

L80B10
>72.000h

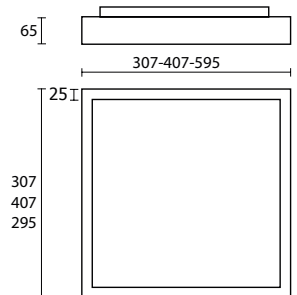



12 FINESTRA IP44 LED

De **FINESTRA IP44 LED** is een modern en universeel opbouwtoestel. Het toestel komt het best tot zijn recht in winkelcentra, hotels, zalen, etc.

Le **FINESTRA LED IP44** est un appareil moderne et universel. L'appareil convient le plus dans les centres commerciaux, les hôtels, les salles, etc.

UPDATE

FINESTRA IP44



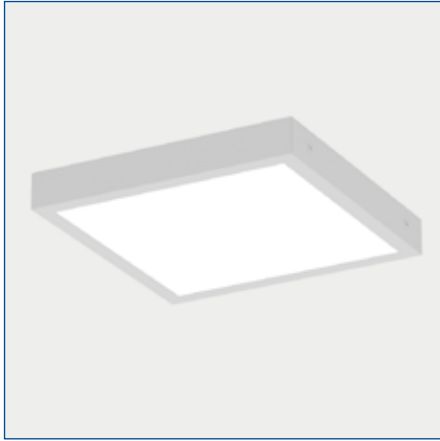

FINESTRA IP44

ALGEMEEN / GÉNÉRALITÉS

TYPE opbouw / apparent

MATERIAL staalplaat / tôle d'acier

OPTION dimming: DALI

KENMERKEN / CARACTÉRISTIQUES

Dimensions	CT	Lm	W	COLOUR	€ PRICE
307x307	3000K 4000K	1660 1710	19W	□ ■ ■	118
407x407	3000K 4000K	2890 2950	32W	□ ■ ■	146
295x595	3000K 4000K	3430 3500	38W	□ ■ ■	165
595x595	3000K 4000K	4120 4200	39W	□ ■ ■	245
595x595	3000K 4000K	6860 7000	67W	□ ■ ■	257
295x1195	3000K 4000K	4120 4200	44W	□ ■ ■	255
295x1195	3000K 4000K	6860 7000	71W	□ ■ ■	266



L80B10
>72.000h

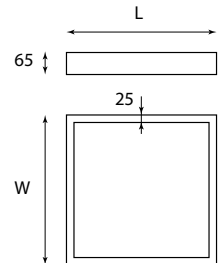



13 SIENA

NEW

De **SIENA** is een IP65 opbouwtoestel, verkrijgbaar met sensor en nood.

Hierdoor is de SIENA ook geschikt voor gangen en traphallen en biedt het toestel een esthetisch alternatief op de SHINE.

Le **SIENA** est un appareil apparent IP65, disponible avec détecteur et secours.

Le SIENA est une alternative esthétique au SHINE et convient donc particulièrement à une installation dans des couloirs et cages d'escalier.

SIENA



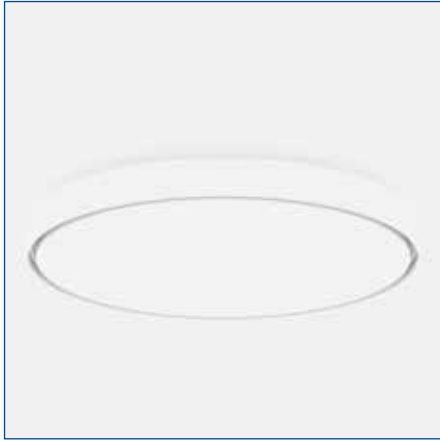

SIENA



ALGEMEEN / GÉNÉRALITÉS

TYPE opbouw / apparent

MATERIAL pvc

OPTION dimming: DALI

KENMERKEN / CARACTÉRISTIQUES

W	CT	Lm	()		COLOUR	€ PRICE
11W	3000K 4000K	1580 1660			<input type="checkbox"/> <input checked="" type="checkbox"/>	104
11W	3000K 4000K	1580 1660	●		<input type="checkbox"/> <input checked="" type="checkbox"/>	137
11W	3000K 4000K	1580 1660		● 1h 3h	<input type="checkbox"/> <input checked="" type="checkbox"/>	205 241
11W	3000K 4000K	1580 1660	●	● 1h 3h	<input type="checkbox"/> <input checked="" type="checkbox"/>	238 247
18W	3000K 4000K	2505 2630			<input type="checkbox"/> <input checked="" type="checkbox"/>	107
18W	3000K 4000K	2505 2630	●		<input type="checkbox"/> <input checked="" type="checkbox"/>	140
18W	3000K 4000K	2505 2630		● 1h 3h	<input type="checkbox"/> <input checked="" type="checkbox"/>	208 244
18W	3000K 4000K	2505 2630	●	● 1h 3h	<input type="checkbox"/> <input checked="" type="checkbox"/>	241 277
23W	3000K 4000K	3440 3610			<input type="checkbox"/> <input checked="" type="checkbox"/>	107
23W	3000K 4000K	3440 3610	●		<input type="checkbox"/> <input checked="" type="checkbox"/>	140
23W	3000K 4000K	3440 3610		● 1h 3h	<input type="checkbox"/> <input checked="" type="checkbox"/>	208 244
23W	3000K 4000K	3440 3610	●	● 1h 3h	<input type="checkbox"/> <input checked="" type="checkbox"/>	241 277



option

L80B10
>72.000h

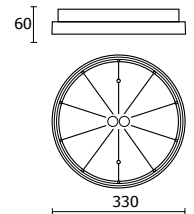



14 SANI

De **SANI** is een standaard opbouw mini-downlight. Het toestel is fase-afsnijding dimbaar en IP54. Hierdoor is het toestel ook geschikt om te plaatsen in badkamers of buiten onder een dakoversteek.

Le **SANI** est un mini downlight standard apparent. L'appareil est dimmable par coupure de phase et IP54. Grâce à cela, l'appareil est également adapté à une utilisation dans des salles de bains ou à l'extérieur sous un auvent.

SANI





SANI

ALGEMEEN / GÉNÉRALITÉS

TYPE opbouw plafond / apparent plafond

MATERIAL aluminium

STANDARD dimming: Triac

KENMERKEN / CARACTÉRISTIQUES

W	CT	Lm	COLOUR	€ PRICE
15W	3000K	1300	□ ■	76

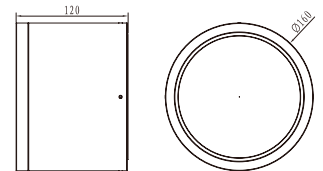



15 MIRROR LED | VIP WALL LED

LED-wandarmatuur met opale plexi diffusor, IP44, 230V aanbevolen voor vochtige ruimtes zoals badkamers. Elektrostatisch gelakt aluminium profiel (standaard grijze kleur).

Applique murale à LED avec diffuseur en plexi opale, IP44, 230V recommandé pour les zones humides telles que les salles de bains. Profilé en aluminium peint électrostatique (couleur grise standard).

MIRROR LED



VIP WALL



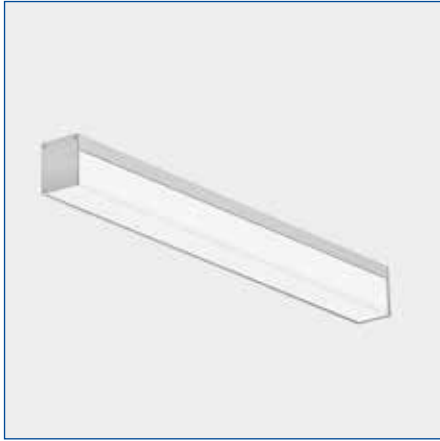

MIRROR LED

ALGEMEEN / GÉNÉRALITÉS

TYPE opbouw plafond, muur / apparent plafond, mur

MATERIAL gelakt aluminium profiel / profil en aluminium peint

OPTION dimming: DALI

KENMERKEN / CARACTÉRISTIQUES

L (mm)	W	CT	Lm	COLOUR	€ PRICE
592	11W	3000K 4000K	1350 1390	□ ■ ▒	95
882	16W	3000K 4000K	2020 2090	□ ■ ▒	147
1172	22W	3000K 4000K	2700 2780	□ ■ ▒	160



option

L80B10
>72.000h

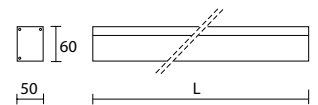

VIP WALL IP44 LED

ALGEMEEN / GÉNÉRALITÉS

TYPE opbouw wand / apparent mur

MATERIAL aluminium

OPTION dimming: DALI

KENMERKEN / CARACTÉRISTIQUES

W	CT	Lm	COLOUR	€ PRICE
13W	3000K 4000K	1235 1265	■	85



option

L80B10
>72.000h

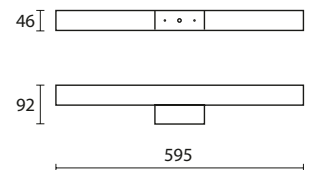



16 LINEA

UPDATE

De **LINEA** wordt onder andere toegepast als algemene of individuele verlichting in gangen, flatgebouwen en sanitaire ruimtes. Het toestel is IK10, IP54 en kan uitgerust worden met sensor, nood en DALI en corridorfunctie.

Le **LINEA** est le plus couramment utilisé comme éclairage général ou individuel dans les couloirs, les immeubles et les locaux sanitaires. L'appareil est IK10, IP54 et peut être équipé d'un détecteur, d'un secours ou d'un driver DALI et fonction corridor.



LINEA ROUND



LINEA SQUARE





LINEA ROUND

ALGEMEEN / GÉNÉRALITÉS

TYPE opbouw wand, plafond / apparent mur, plafond

MATERIAL polycarbonaat / polycarbonate

OPTION dimming: DALI | 3000K

KENMERKEN / CARACTÉRISTIQUES

W	CT	Lm	COLOUR	€ PRICE
10W	4000K	1550	☐	67
12W	4000K	1900	☐	67
14W	4000K	2200	☐	67
16W	4000K	2500	☐	67
24W	4000K	3600	☐	84



L90B10
>50.000h

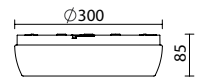

LINEA SQUARE

ALGEMEEN / GÉNÉRALITÉS

TYPE opbouw wand, plafond / apparent mur, plafond

MATERIAL polycarbonaat / polycarbonate

OPTION dimming: DALI | 3000K

KENMERKEN / CARACTÉRISTIQUES

W	CT	Lm	COLOUR	€ PRICE
10W	4000K	1550	☐	76
12W	4000K	1900	☐	76
14W	4000K	2200	☐	76
16W	4000K	2500	☐	76
24W	4000K	3600	☐	94



L90B10
>50.000h

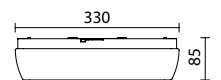



17 SHINE

De **SHINE** is door zijn goede prijs/kwaliteitverhouding uitgegroeid tot een bestseller binnen het gamma. Het toestel is vervaardigd uit een polycarbonaat behuizing en acrylaat diffuser. Onder andere hierdoor biedt de SHINE een IK08 slagvastheid en IP54-beschermingsgraad. Naast de standaardversie is het toestel ook verkrijgbaar met sensor, nood en sensor + nood.

Le **SHINE** est devenu un best-seller dans la gamme en raison de son excellent rapport qualité/prix. L'appareil est constitué d'un boîtier en polycarbonate et d'un diffuseur en acrylate. Le SHINE a, entre autres, une résistance aux chocs IK08 et un degré de protection IP54. En plus de la version standard, l'appareil est également disponible avec détecteur, détecteur + secours ou secours.

SHINE





SHINE

ALGEMEEN / GÉNÉRALITÉS

TYPE opbouw plafond / apparent plafond

MATERIAL polycarbonaat methacrylaat / polyméthacrylate de méthyle

KENMERKEN / CARACTÉRISTIQUES

W	CT	Lm	(Wi)	EMERGENCY	COLOUR	€ PRICE
25W	3000K	2200			□	78
25W	3000K	2200	●		□	112
25W	3000K	2200	●	●	□	158
25W	4000K	2300			□	78
25W	4000K	2300	●		□	112
25W	4000K	2300	●	●	□	158

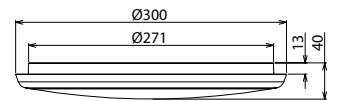

SHINE MINI

KENMERKEN / CARACTÉRISTIQUES

W	CT	Lm	(Wi)	EMERGENCY	COLOUR	€ PRICE
12W	3000K	1080			□	48
12W	4000K	1250			□	48

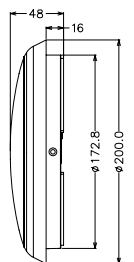



18 NOA 50 | 100 TOP

De **NOA 50 TOP / NOA 100 TOP** is een vaste ronde IP66 opbouwspot geschikt voor vochtige binnenomgevingen zoals badkamers of buitenomgevingen. De behuizing is vervaardigd uit aluminium met polyesterharscoating voor een hoge weerstand tegen oxidatie. De Noa is standaard uitgerust met een overspanningsbeveiliging (1KW), G1/2 kabelwartel, osmotisch ventiel en sluitdop voor een ultieme bescherming tegen waterschade.

Le **NOA 50 TOP / NOA 100 TOP** est un spot fixe apparent IP66 pour les environnements intérieurs humides tels que les salles de bains ou les environnements extérieurs. Le boîtier est en aluminium avec revêtement en résine polyester pour une haute résistance à l'oxydation. Le Noa est équipé en standard d'une protection contre les surtensions (1KW), d'un presse-étoupe G1/2, d'une vanne osmotique et d'un bouchon étanche pour une protection ultime contre les dégâts d'eau.

NOA TOP





NOA 50 TOP

ALGEMEEN / GÉNÉRALITÉS

TYPE	opbouw plafond, wand, vloer / apparent plafond, mur, sol
MATERIAL	die-cast aluminium
DIFFUSER	gehard en gezeefdrukt glas / verre trempé et sérigraphié
OPTIC	diff. 25° 40° 60°
STANDARD	dimming: TRIAC

KENMERKEN / CARACTÉRISTIQUES

W	CT	Lm	COLOUR	€ PRICE
9W	2700K	676	□ ■ ■ ■	129
9W	3000K	712	□ ■ ■ ■	129
9W	4000K	750	□ ■ ■ ■	129



L80B20
>50.000h

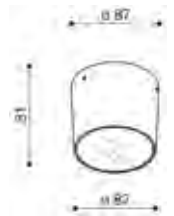

NOA 100 TOP

KENMERKEN / CARACTÉRISTIQUES

W	CT	Lm	COLOUR	€ PRICE
16W	2700K	1083	□ ■ ■ ■	146
16W	3000K	1140	□ ■ ■ ■	146
16W	4000K	1200	□ ■ ■ ■	146



L80B20
>50.000h



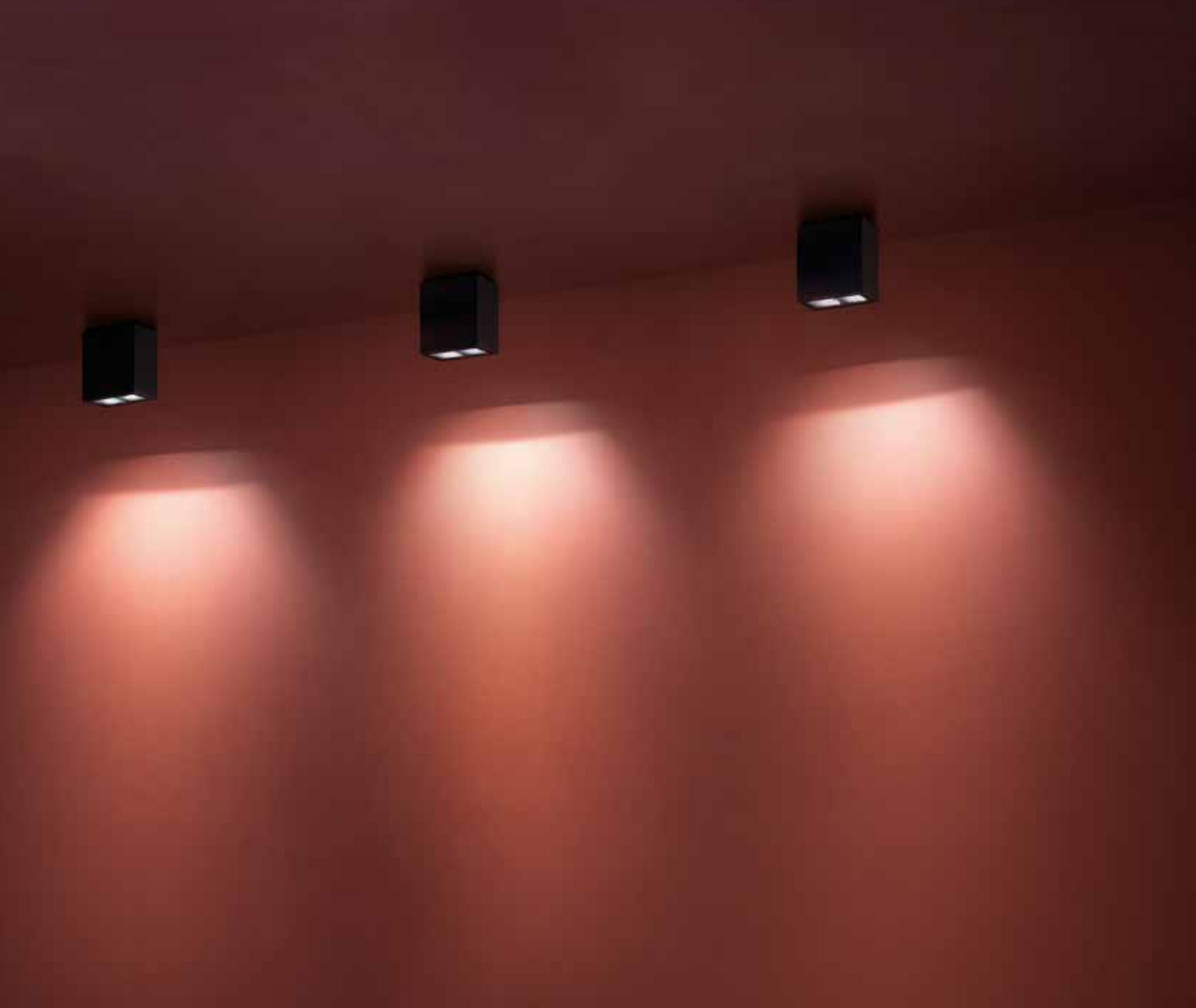

19 KURA TOP

NEW

De **KURA TOP** is een strak en elegant opbouwtoestel, beschikbaar met 1, 2 of 5 lichtpunten. Het toestel is IP65 en dus geschikt voor zowel binnen- als buitentoepassingen.

De **KURA TOP** is vervaardigd uit aluminium en zowel beschikbaar als vast- en richtbare uitvoering.

Le **KURA TOP** est un appareil apparent épuré et élégant, disponible avec 1, 2 ou 5 points lumineux. L'appareil est IP65 et donc adapté aux applications intérieures et extérieures.

Le **KURA TOP** est fabriqué en aluminium et disponible en version fixe et réglable.

KURA TOP





KURA TOP X1

ALGEMEEN / GÉNÉRALITÉS

TYPE	opbouw plafond, wand/ apparent plafond, mur
MATERIAL	aluminium roestvrij staal / aluminium acier inoxydable
DIFFUSER	gehard en gezeefdrukt glas / verre trempé et sérigraphié

KENMERKEN / CARACTÉRISTIQUES

W	Lm	A	COLOUR	€ PRICE
2W	180	18°		83
2W	180	28°		83
2W	180	52°		83



L80B20
>50.000h

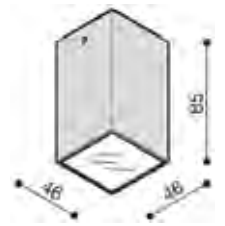

KURA TOP X2

KENMERKEN / CARACTÉRISTIQUES

W	Lm	A	COLOUR	€ PRICE
4W	360	18°		126
4W	360	28°		126
4W	360	52°		126



L80B20
>50.000h

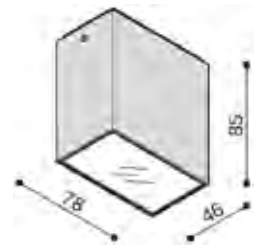

KURA TOP X5

KENMERKEN / CARACTÉRISTIQUES

W	Lm	A	COLOUR	€ PRICE
10W	900	18°		161
10W	900	28°		161
10W	900	52°		161



L80B20
>50.000h

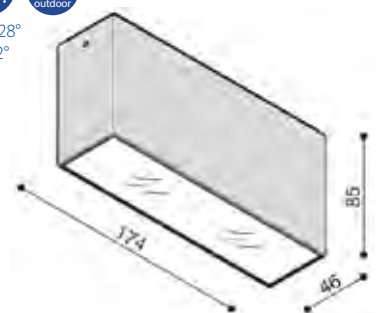



20 ART

Stijl door eenvoud. De **ART** is designtechnisch een eenvoudig vormgegeven toestel uit polycarbonaat. De ART wordt van binnenuit perfect egaal verlicht en beschikt daarnaast over technisch optimale eigenschappen (IP66, IK10) voor buitenmontage onder bijvoorbeeld een afdak. De **ART** kan eventueel afgewerkt worden met een decoratieve afdekking die naar wens individueel gepersonaliseerd kan worden.

Distingué grâce à sa simplicité. L'**ART** est un appareil design technique en polycarbonate. L'ART est uniformément éclairé de l'intérieur et possède également des propriétés techniques optimales (IP66, IK10) pour une installation en extérieur, par exemple sous un auvent. L'**ART** peut éventuellement être habillé d'un couvercle décoratif qui, selon vos souhaits, peut également être personnalisé individuellement.

ART





ART 250

ALGEMEEN / GÉNÉRALITÉS

TYPE opbouw wand, plafond / apparent mur, plafond

MATERIAL polycarbonaat / polycarbonate

KENMERKEN / CARACTÉRISTIQUES

W	CT	Lm	COLOUR	€ PRICE
20W	2700K	1573	□	112
20W	3000K	1573	□	112
20W	4000K	1656	□	112



L80B20
>50.000h

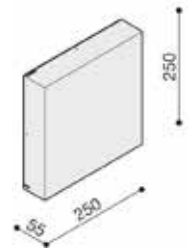

ART 250 MASK

ALGEMEEN / GÉNÉRALITÉS

TYPE opbouw wand, plafond / apparent mur, plafond

MATERIAL polycarbonaat / polycarbonate

OPTION dimming: DALI

KENMERKEN / CARACTÉRISTIQUES

W	CT	Lm	COLOUR	€ PRICE
17W	2700K	1231	□ ■ □ ■ ■ ■ ■	138
17W	3000K	1231	□ ■ □ ■ ■ ■ ■	138
17W	4000K	1296	□ ■ □ ■ ■ ■ ■	138



L80B20
>50.000h

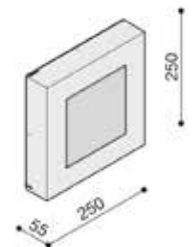





ART 100

ALGEMEEN / GÉNÉRALITÉS

TYPE opbouw plafond, wand / apparent plafond, mur

MATERIAL polycarbonaat / polycarbonate

KENMERKEN / CARACTÉRISTIQUES

W	CT	Lm	COLOUR	€ PRICE
10W	2700K	762	□	78
10W	3000K	762	□	78
10W	4000K	802	□	78



L80B20
>50.000h

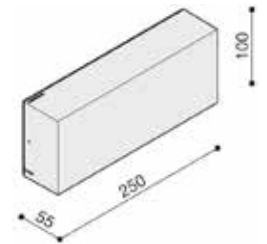

ART 100 TOP

ALGEMEEN / GÉNÉRALITÉS

TYPE opbouw wand / apparent mur

MATERIAL polycarbonaat / polycarbonate

KENMERKEN / CARACTÉRISTIQUES

W	CT	Lm	COLOUR	€ PRICE
10W	2700K	460	□ ■ ▒ ▒ ▒	91
10W	3000K	460	□ ■ ▒ ▒ ▒	91
10W	4000K	484	□ ■ ▒ ▒ ▒	91



L80B20
>50.000h

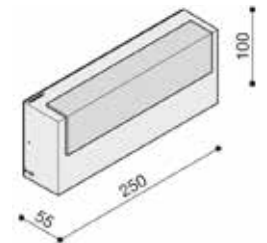



21 NOA 50 | 100 WALL

De **NOA 50 / NOA 100** is een richtbare IP66 spot voor plafond- of wandmontage. Door de diverse diffusors en anti-reflectiefilter (optie) is de NOA 50/100 uitermate geschikt als accentspot. De behuizing is vervaardigd uit aluminium met polyesterharscoating voor een hoge weerstand tegen oxidatie. De Noa is standaard uitgerust met een overspanningsbeveiliging (1KW), G1/2 kabelwartel, osmotisch ventiel en sluitdop voor een ultieme bescherming tegen waterschade.

Le **NOA 50 / NOA 100** est un spot orientable IP66 pour un montage au plafond ou au mur. Grâce aux différents diffuseurs et filtre antireflets (option), le NOA 50/100 est parfaitement adapté comme projecteur d'accentuation. Le boîtier est en aluminium avec revêtement en résine polyester pour une haute résistance à l'oxydation. Le Noa est équipé en standard d'une protection contre les surtensions (1KW), d'un presse-étoupe G1/2, d'une vanne osmotique et d'un bouchon étanche pour une protection ultime contre les dégâts d'eau.

NOA WALL





NOA 50 WALL

ALGEMEEN / GÉNÉRALITÉS

TYPE opbouw plafond, wand / apparent plafond, mur

MATERIAL aluminium

DIFFUSER gehard en gezeefdrukt glas / verre trempé et sérigraphié

OPTIC diff. | 25° | 40° | 60°

STANDARD dimming: TRIAC

KENMERKEN / CARACTÉRISTIQUES

W	CT	Lm	COLOUR	€ PRICE
9W	2700K	708		146
9W	3000K	712		146
9W	4000K	750		146



L80B20
>50.000h



NOA 100 WALL

KENMERKEN / CARACTÉRISTIQUES

W	CT	Lm	COLOUR	€ PRICE
16W	2700K	1083		163
16W	3000K	1140		163
16W	4000K	1200		163



L80B20
>50.000h



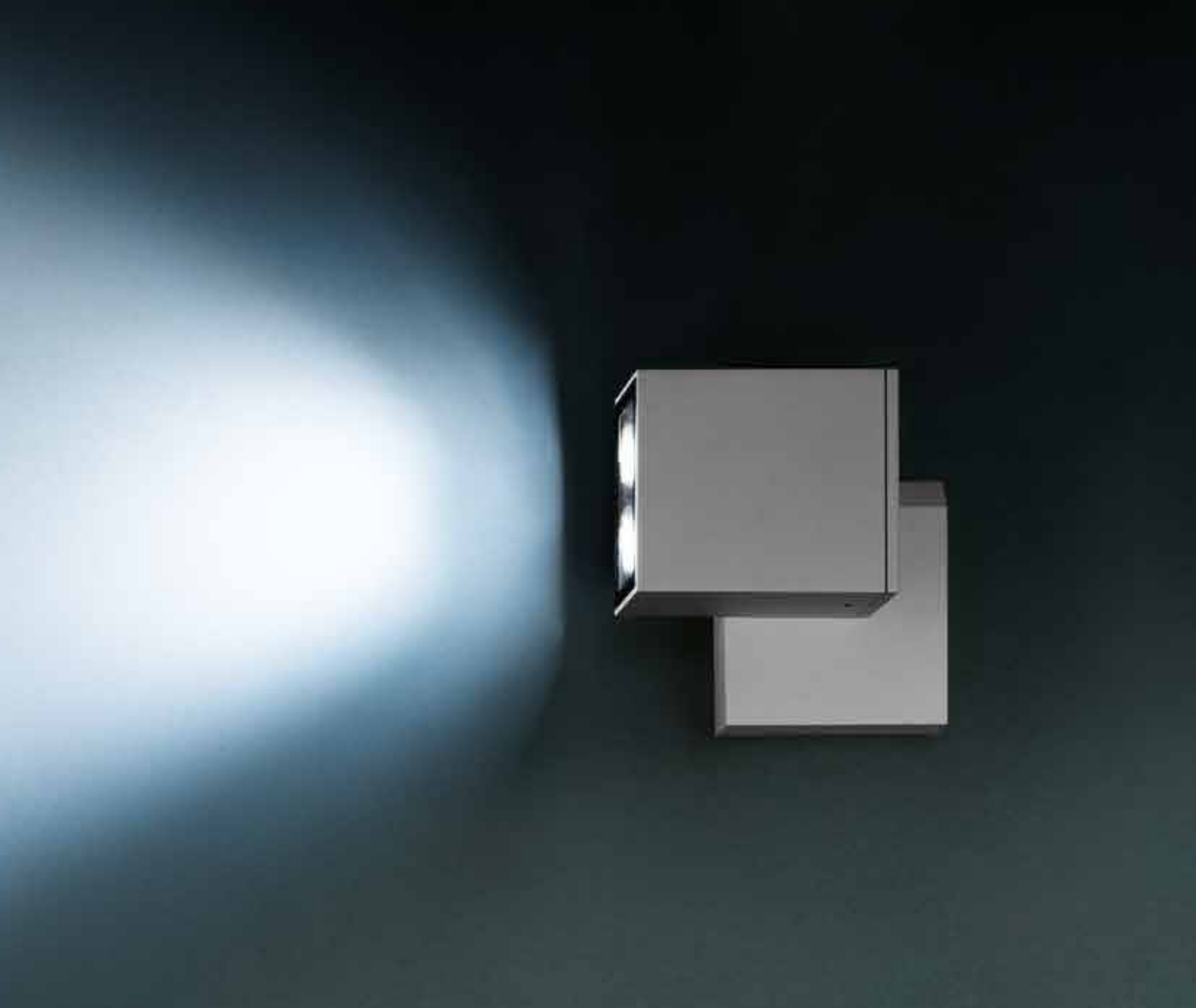

22 KURA REG X2

NEW

De **KURA REG** is een richtbare IP65 opbouwspot voor wandmontage. De behuizing is vervaardigd uit aluminium met een diffuser uit gehard zeefdrukglas.

Het toestel is zowel horizontaal als verticaal richtbaar.

Le **KURA REG** est un spot apparent orientable IP65 pour montage mural. Le boîtier est en aluminium avec un diffuseur en verre trempé sérigraphié.

L'appareil peut être orienté aussi bien horizontalement que verticalement.

KURA REG X2





KURA REG X2

ALGEMEEN / GÉNÉRALITÉS

TYPE	opbouw plafond, wand / apparent plafond, mur
MATERIAL	aluminium roestvrij staal / aluminium acier inoxydable
DIFFUSER	gehard en gezeefdrukt glas / verre trempé et sérigraphié

KENMERKEN / CARACTÉRISTIQUES

W	CT	Lm	COLOUR	€ PRICE
4W	2700K 3000K 4000K	360	<input type="checkbox"/> <input type="checkbox"/> <input type="checkbox"/> <input type="checkbox"/>	209



L80B20
>50.000h

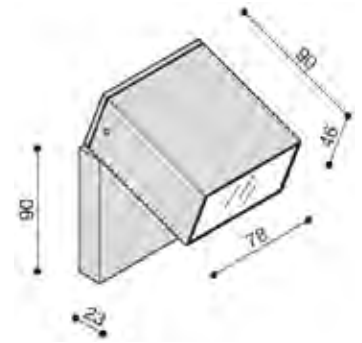



23 TAPE

NEW

De **TAPE** is een elegant en sober wandtoestel zowel geschikt voor plaatsing binnen als buiten.
Het toestel is vervaardigd uit aluminium en een diffuser uit mat glas.
Door middel van elektroforese en een polyester coating is het toestel uitermate bestand tegen oxidatie en UV-stralen.

Le **TAPE** est une applique mural élégant et sobre, adapté à un usage intérieur et extérieur.
L'appareil est composé d'aluminium et d'un diffuseur en verre trempé.
Grâce à l'électrophorèse et à un revêtement en polyester, le dispositif est extrêmement résistant à l'oxydation et aux rayons UV.

TAPE





TAPE 80

ALGEMEEN / GÉNÉRALITÉS

TYPE	opbouw plafond, wand / apparent plafond, mur
MATERIAL	aluminium roestvrij staal / aluminium acier inoxydable
DIFFUSER	mat glas / verre dépoli

KENMERKEN / CARACTÉRISTIQUES

W	CT	Lm	COLOUR	€ PRICE
2W	2700K 3000K 4000K	248 248 248	□ ■ ■ ■ ■	91



L80B20
>50.000h

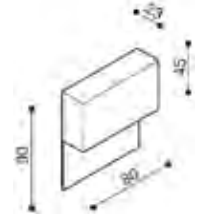

TAPE 140

KENMERKEN / CARACTÉRISTIQUES

W	CT	Lm	COLOUR	€ PRICE
4W	2700K 3000K 4000K	419 419 419	□ ■ ■ ■ ■	103



L80B20
>50.000h

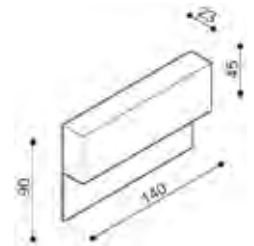

TAPE 220

KENMERKEN / CARACTÉRISTIQUES

W	CT	Lm	COLOUR	€ PRICE
6W	2700K 3000K 4000K	800 800 800	□ ■ ■ ■ ■	115



L80B20
>50.000h

TAPE 220 AC DIRECT

KENMERKEN / CARACTÉRISTIQUES

W	CT	Lm	COLOUR	€ PRICE
4,6W	2700K 3000K 4000K	550 550 550	□ ■ ■ ■ ■	120



L87B20
>50.000h

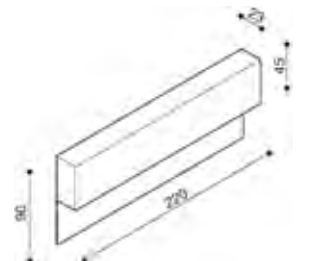

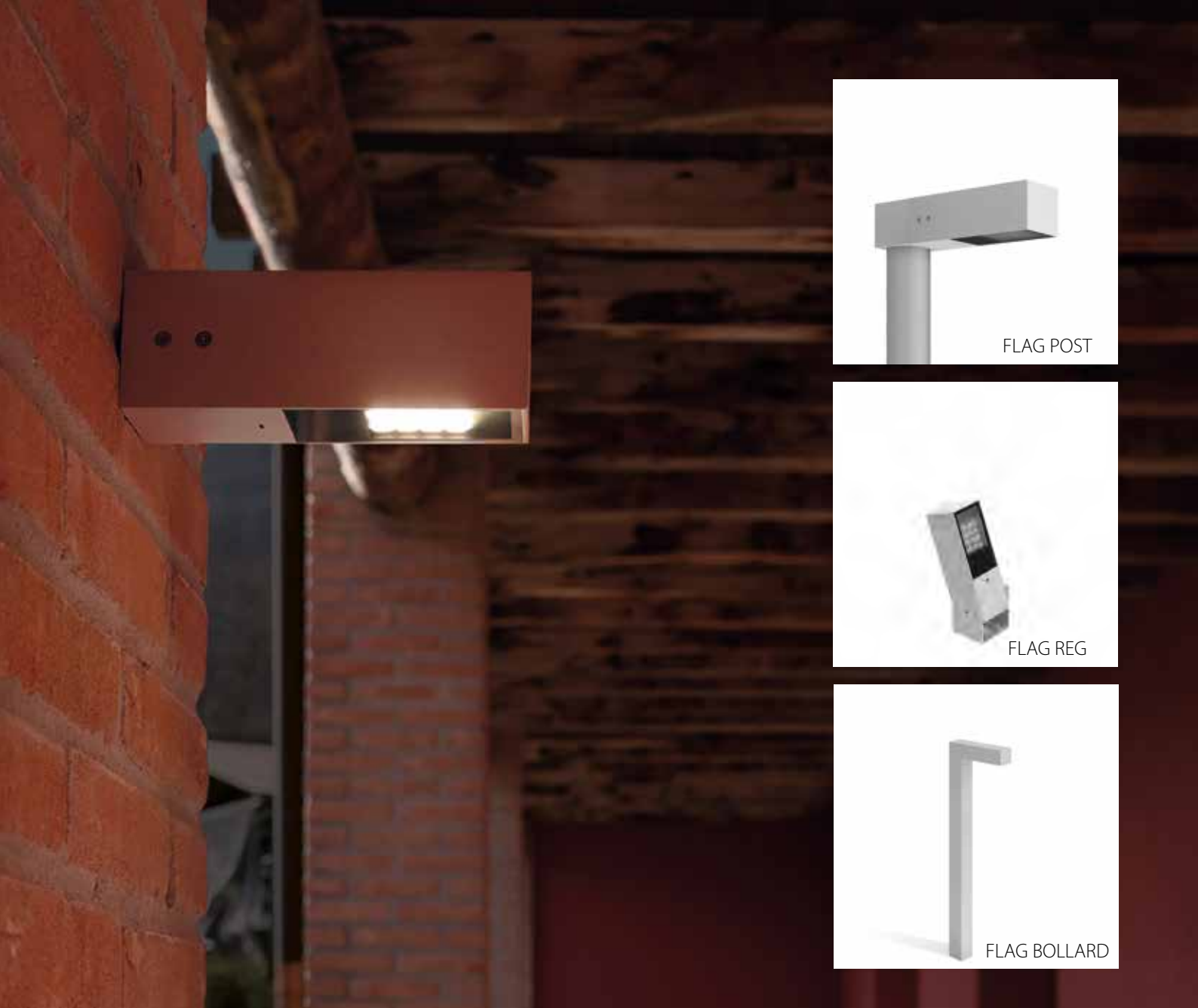

24 FLAG

NEW

De **FLAG** is een compacte straler met een moderne vormgeving. Het toestel wordt rechtstreeks op de muur bevestigd en kan daarnaast door middel van een accessoire ook tot tuinpaal omgevormd worden. De **FLAG** is beschikbaar met volgende lenzen: spot (25°), breed, asymmetrisch of diffuus.

Le **FLAG** est un projecteur compact au design moderne. Il se fixe directement au mur et peut également être transformé en potelet de jardin au moyen d'un accessoire. Le **FLAG** est disponible avec les objectifs suivants : spot (25°), large, asymétrique ou diffus.

FLAG 200





FLAG 200

ALGEMEEN / GÉNÉRALITÉS

TYPE opbouw plafond, wand / apparent plafond, mur

MATERIAL aluminium

DIFFUSER gehard en gezeefdrukt glas / verre trempé et sérigraphié

OPTION dimming: DALI

KENMERKEN / CARACTÉRISTIQUES

W	CT	Lm	COLOUR	€ PRICE
10W	2700K 3000 K 4000K	1350 1350 1350	□ ■ ■ ■	189



L80B20
>50.000h



FLAG 330

KENMERKEN / CARACTÉRISTIQUES

W	CT	Lm	COLOUR	€ PRICE
19W	2700K 3000 K 4000K	2850 2850 2850	□ ■ ■ ■	240



L80B20
>50.000h

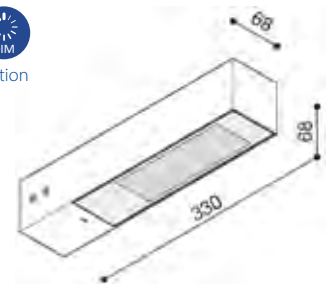

FLAG 430

KENMERKEN / CARACTÉRISTIQUES

W	CT	Lm	COLOUR	€ PRICE
35W	2700K 3000 K 4000K	4575 4575 4575	□ ■ ■ ■	371



L80B20
>50.000h

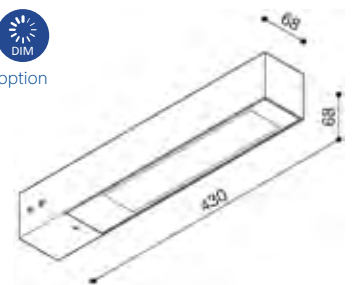

MOGELIJKHEDEN / POSSIBILITES

Zie foto's op hiernaast / Voir les photos ci-contre



25 AGO APPLIQUE

NEW

De **AGO APPLIQUE** is een IP66 down- en up/down-wandtoestel vervaardigd uit geanodiseerd aluminium.

L'**AGO APPLIQUE** est un appareil mural IP66 haut/bas en aluminium anodisé.

AGO APPLIQUE





AGO APPLIQUE

ALGEMEEN / GÉNÉRALITÉS

TYPE opbouw wand / apparent mur

MATERIAL aluminium

DIFFUSER gehard en gezeefdrukt glas / verre trempé et sérigraphié

STANDARD dimming: TRIAC

OPTIC diff. | 25° | 40° | 65°

KENMERKEN / CARACTÉRISTIQUES

TYPE	W	CT	Lm	COLOUR	€ PRICE
DOWN	5W	2700K 3000K 4000K	497 497 497	□ ■ ■ ■	172
UP&DOWN	10W	2700K 3000K 4000K	996 996 996	□ ■ ■ ■	215



L80B20
>50.000h

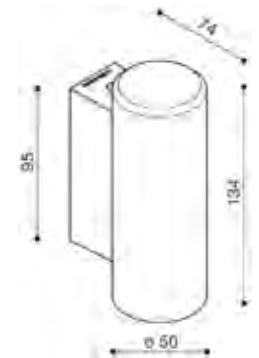



26 TREND 60 | TREND 60 BLADE

NEW

Het **TREND**-gamma bestaat uit een reeks IP66 down- en up/down-wandtoestellen vervaardigd uit aluminium met polyester coating. Ook is er bijhorende tuinpaal (60 cm) als accessoire beschikbaar.

La gamme **TREND** se compose d'une série d'appiques murales IP66 down- et up/down en aluminium avec revêtement polyester. Un poteau de jardin assorti (60 cm) est également disponible en accessoire.

TREND 60





TREND 60 | TREND 60 BLADE

ALGEMEEN / GÉNÉRALITÉS

TYPE opbouw wand / apparent mur

MATERIAL aluminium

DIFFUSER gehard en gezeefdrukt glas / verre trempé et sérigraphié

KENMERKEN / CARACTÉRISTIQUES

TYPE	W	CT	Lm	COLOUR	€ PRICE
DOWN	3W	2700K 3000K 4000K	500	<input type="checkbox"/> <input type="checkbox"/> <input type="checkbox"/> <input type="checkbox"/>	129
DOWN	6W	2700K 3000K 4000K	1000	<input type="checkbox"/> <input type="checkbox"/> <input type="checkbox"/> <input type="checkbox"/>	163
UP&DOWN	6W	2700K 3000K 4000K	1000	<input type="checkbox"/> <input type="checkbox"/> <input type="checkbox"/> <input type="checkbox"/>	163

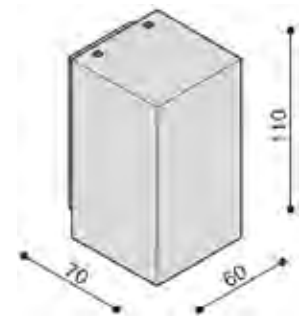



27 TRITON

NEW

De **TRITON** is een IP65 opbouwtoestel die optioneel uitgerust kan worden met sensor, nood en DALI.

Daardoor is dit een uitstekende oplossing voor buitengangen en -trappen.

Le **TRITON** est un appareil en saillie IP65 qui peut être équipé en option d'un capteur, d'une urgence et d'un DALI.

Cela en fait une excellente solution pour les couloirs et les escaliers extérieurs.

TRITON





TRITON 1

ALGEMEEN / GÉNÉRALITÉS

TYPE opbouw wand / apparent mur

MATERIAL polycarbonaat / polycarbonate

OPTION dimming: DALI

KENMERKEN / CARACTÉRISTIQUES

W	CT	Lm	COLOUR	€ PRICE
14W	3000K 4000K	2000 2110	□ ■ ■	164
19W	3000K 4000K	2590 2700	□ ■ ■	174



L80B10
>50.000h

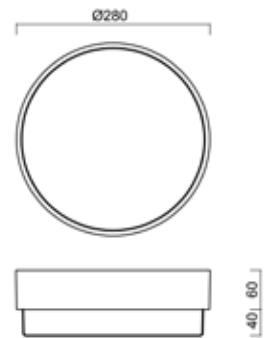

TRITON 2

KENMERKEN / CARACTÉRISTIQUES

W	CT	Lm	COLOUR	€ PRICE
20W	3000K 4000K	2770 2920	□ ■ ■	205
27W	3000K 4000K	3880 4050	□ ■ ■	207



L80B10
>50.000h

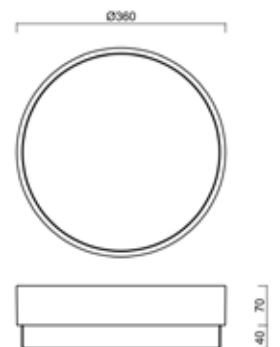



28 TUBO LED

De **TUBO LED** is een krachtig, minimalistisch pendeltoestel met ingebouwde driver en LED-module. De TUBO bestaat uit de module met de componenten en de lege behuizing als verlengstuk die de lengte van het toestel bepaalt.

Le **TUBO LED** est une suspension puissante et minimaliste avec un module LED et un driver intégré. Le TUBO LED se compose d'un module et d'un cylindre vide comme extension.

TUBO LED





TUBO LED

ALGEMEEN / GÉNÉRALITÉS

TYPE opbouw plafond / apparent plafond

MATERIAL aluminium

OPTION dimming: DALI

KENMERKEN / CARACTÉRISTIQUES

W	CT	Lm	COLOUR	€ PRICE
15W	3000K 4000K	1420 1460	<input type="checkbox"/> <input type="checkbox"/> <input type="checkbox"/>	151
21W	3000K 4000K	1960 2020	<input type="checkbox"/> <input type="checkbox"/> <input type="checkbox"/>	151
29W	3000K 4000K	2550 2630	<input type="checkbox"/> <input type="checkbox"/> <input type="checkbox"/>	151



option 30-50-70°

L90B10
>60.000h

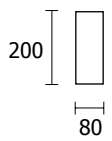

ACCESSOIRES

Lege module / Module vide : 400 mm - 800 mm - 1200 mm



29 NEO BALL

De **NEO BALL** is een decoratieve pendel die deel uitmaakt van een volledige familie voor inbouw-, opbouw-, pendel- en railtoepassingen.

Le **NEO BALL** est une suspension décorative qui fait partie d'une famille complète pour applications encastrées, apparentes, suspendues ou sur rail.

NEW

NEO BALL





NEO BALL

ALGEMEEN / GÉNÉRALITÉS

TYPE opbouw plafond, pendel / apparent plafond, suspendu

MATERIAL aluminium

OPTION dimming: DALI

KENMERKEN / CARACTÉRISTIQUES

W	CT	Lm	ø mm	COLOUR	€ PRICE
28W	2700K	2140	180 mm	□ ■	443
28W	3000K	2181	180 mm	□ ■	443



option

2,5 m

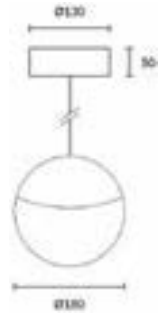



30 NEO AIR

NEW

De **NEO AIR** is een decoratieve pendel die deel uitmaakt van een volledige familie voor inbouw-, opbouw-, pendel- en railtoepassingen.

Le **NEO AIR** est une suspension décorative qui fait partie d'une famille complète pour applications encastrées, apparentes, suspendues ou sur rail.

NEO AIR





NEO AIR

ALGEMEEN / GÉNÉRALITÉS

TYPE opbouw plafond, pendel / apparent plafond, suspendu

MATERIAL aluminium

OPTION dimming: DALI

KENMERKEN / CARACTÉRISTIQUES

Type	ø mm	CT	W	Lm	€ PRICE
S	30 mm	2700K	8W	267	225
S	30 mm	3000K	8W	312	225
L	52 mm	2700K	19W	1134	270
L	52 mm	3000K	19W	1219	270



option 30-50°

2,5 m

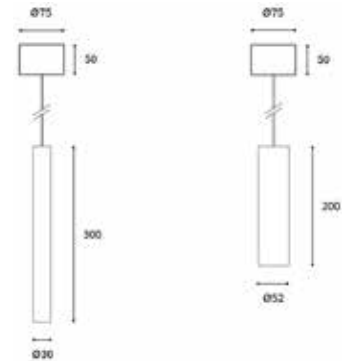

ACCESSOIRES

Inner ring for Neo S/L - Gold

Inner ring for Neo S/L - White

Honeycomb for Neo S/L

Reflectors: 15° | 50°



31 ISIS

NEW

De **ISIS** is een design pendelarmatuur verkrijgbaar in diameter van 200 tot 500 mm en lichtopbrengsten tot $\pm 6000\text{Lm}$. Daarnaast is het toestel zowel verkrijgbaar met DALI als met noodunit.

L'**ISIS** est un luminaire suspendu design dans des diamètres allant de 200 à 500 mm et avec des puissance lumineuses allant jusqu'au $\pm 6000\text{Lm}$.

A côté de cela, l'appareil est également disponible en version DALI ou avec secours.

ISIS





ISIS

ALGEMEEN / GÉNÉRALITÉS

TYPE	pendel / suspendu
MATERIAL	staalplaat / tôle d'acier
DIFFUSER	polyethyleen / polyéthylène

KENMERKEN / CARACTÉRISTIQUES

TYPE	W	Ø	Lm	CT	COLOUR	€ PRICE
ISIS L1 200	9W	200	1070	3000K	□ ■ ■ ■	260
ISIS L1 200	9W	200	2700	4000K	□ ■ ■ ■	260
ISIS L2 300	20W	300	2970	3000K	□ ■ ■ ■	438
ISIS L2 300	20W	300	3130	4000K	□ ■ ■ ■	438
ISIS L3 400	27W	400	3900	3000K	□ ■ ■ ■	478
ISIS L3 400	27W	400	4110	4000K	□ ■ ■ ■	478
ISIS L4 500	41W	500	5880	3000K	□ ■ ■ ■	632
ISIS L4 500	41W	500	6200	4000K	□ ■ ■ ■	632



L80B10
>50.000h

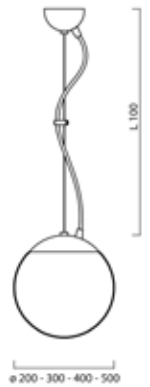



32 EGO LED EVO

NEW

De **EGO LED EVO** is een decoratief kloktoestel verkrijgbaar met een aluminium of polycarbonaat diffusor. Door het lage gewicht (1,55 kg) kan het toestel zowel als opbouw als 3F-rail versie uitgevoerd worden.

L'**EGO LED EVO** est une cloche décorative disponible avec un diffuseur en aluminium ou en polycarbonate. Grâce à son faible poids (1,55 kg), l'appareil peut être installé en apparent ou sur un rail 3F.

EGO LED EVO





EGO LED EVO

ALGEMEEN / GÉNÉRALITÉS

TYPE opbouw plafond, pendel / apparent plafond, suspendu

MATERIAL aluminium

OPTION dimming: DALI

REFLECTOR 320mm | aluminium or polycarbonate | wide beam 120°

KENMERKEN / CARACTÉRISTIQUES

W	CT	Lm	COLOUR	€ PRICE
9,5W	3000K 4000K	1715	■	197
13W	3000K 4000K	2390	■	197
23W	3000K 4000K	4050	■	212
30W	3000K 4000K	5370	■	225



L80B10
>50.000h





33 GEOMETRIC RING LED

De **GEOMETRIC RING LED** is een technisch toestel die de esthetische eigenschappen met een prestigieus decoratief toestel deelt. De GEOMETRIC wordt toegepast in vergaderzalen, klaslokalen en andere plaatsen waar een uniform en sterk licht vereist is.

Le **GEOMETRIC RING LED** est un appareil technique qui partage les propriétés esthétiques d'un prestigieux appareil décoratif. Le GEOMETRIC se place dans des salles de conférence, salles de classe et autres endroits où une lumière uniforme et intense est exigée.

GEOMETRIC RING
LED



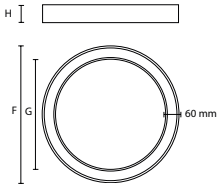
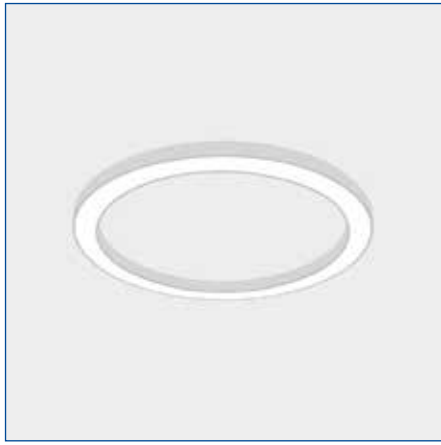

	H	F	G
	62	640	520
	62	820	700
	62	1000	880

GEOMETRIC RING MINI LED

ALGEMEEN / GÉNÉRALITÉS

TYPE opbouw | pendel / encastré / suspendu

MATERIAL gelakt aluminium profiel / profil en aluminium peint

DIFFUSER OPAL

OPTION dimming: DALI

KENMERKEN / CARACTÉRISTIQUES

INFO	W	CT	Lm	Ø (mm)	COLOUR	€ PRICE
DI	38W	3000K	4525	640	□ ■ ●	372
DI	38W	4000K	4745	640	□ ■ ●	372
DI	50W	3000K	6030	820	□ ■ ●	491
DI	50W	4000K	6325	820	□ ■ ●	491
DI	63W	3000K	7530	1000	□ ■ ●	581
DI	63W	4000K	7900	1000	□ ■ ●	581



option

L80B10
>72.000h

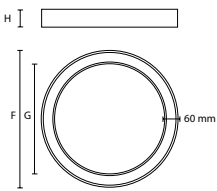
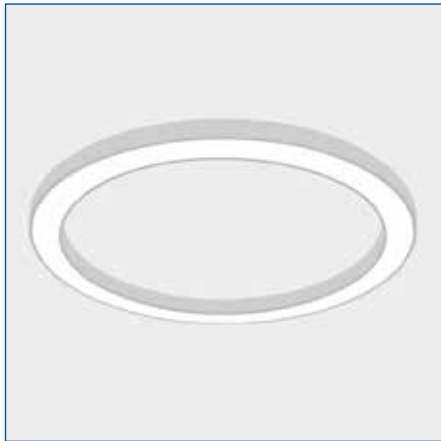

	H	F	G
	62	1400	1200
	62	1600	1400
	62	2100	1900
	62	2800	2600
	62	4000	3800
	62	5300	5100
DI/IN	108	1600	1400
DI/IN	108	2000	1800

GEOMETRIC RING MAX LED

KENMERKEN / CARACTÉRISTIQUES

INFO	W	CT	Lm	Ø (mm)	COLOUR	€ PRICE
DI	146W	3000K 4000K	15600 15900	1400	□ ■ ●	1426
DI	166W	3000K 4000K	17700 18000	1600	□ ■ ●	1480
DI	220W	3000K 4000K	23700 24200	2100	□ ■ ●	1899
DI	300W	3000K 4000K	32400 33000	2800	□ ■ ●	2347
DI	429W	3000K 4000K	46100 47000	4000	□ ■ ●	3222
DI	574W	3000K 4000K	61600 62800	5300	□ ■ ●	3984
DI/IN	267W	3000K 4000K	25660 26370	1600	□ ■ ●	1504
DI/IN	334W	3000K 4000K	31920 32800	2000	□ ■ ●	1980



option

L80B10
>72.000h



34 OVALO

NEW

De **OVALO** is een familie design opbouwtoestellen zowel verkrijgbaar als vierkante, rechthoekige en driehoekige versie. De opbouwtoestellen kunnen door middel van een accessoire ook gependeld worden.

L'**OVALO** est une famille d'appareils apparents design disponibles en versions carrées, rectangulaires et triangulaires. Ces appareils peuvent également être suspendus à l'aide d'un kit de suspension.

OVALO



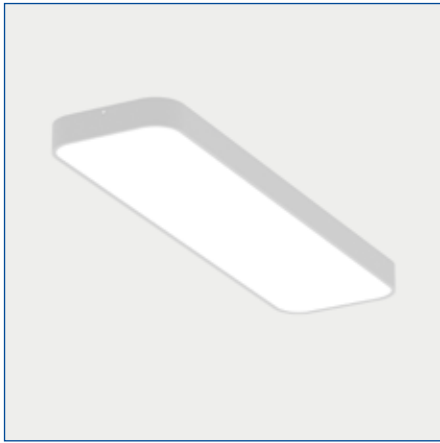

OVALO RECTANGLE

ALGEMEEN / GÉNÉRALITÉS

TYPE opbouw, pendel / apparent, suspendu

MATERIAL aluminium

DIFFUSER OPAL

OPTION dimming: DALI

KENMERKEN / CARACTÉRISTIQUES

W	CT	Lm	COLOUR	€ PRICE
32W	3000K 4000K	3470 3630	□ ■ ●	364
41W	3000K 4000K	4430 4630	□ ■ ●	364



L80B10
>72.000h

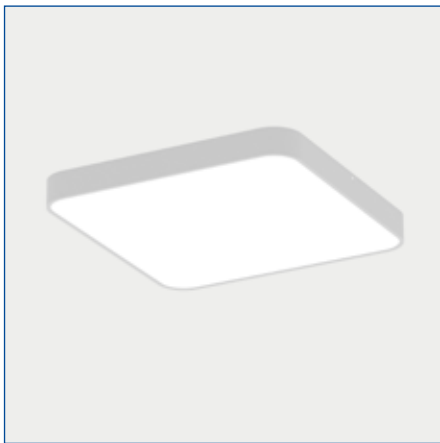
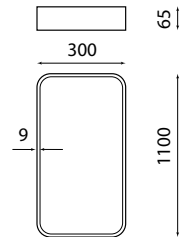

OVALO SQUARE

KENMERKEN / CARACTÉRISTIQUES

W	CT	Lm	COLOUR	€ PRICE
32W	3000K 4000K	3590 3770	□ ■ ●	329
41W	3000K 4000K	4580 4810	□ ■ ●	345



L80B10
>72.000h

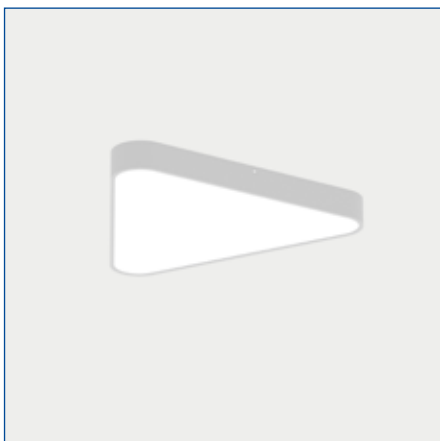
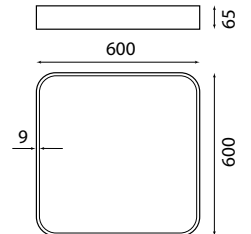

OVALO TRIANGLE

KENMERKEN / CARACTÉRISTIQUES

W	CT	Lm	COLOUR	€ PRICE
21W	3000K 4000K	2130 2230	□ ■ ●	OA / SD
30W	3000K 4000K	3000 3130	□ ■ ●	OA / SD



L80B10
>72.000h

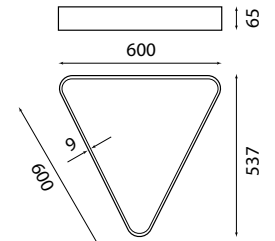

ACCESSOIRES

Electrical suspension | Grey, White, Black

Simple suspension



35 POKER Q LS LED

NEW

De **POKER Q** is een modulair lijnsysteem voorzien van voorgesmonteerde doorvoerbekabeling. Door de afwerkingsgraad, verschillende optieken (60°, 90° en asymmetrisch) en mogelijkheid om richtbare spots te combineren, is dit een interessante oplossing voor toepassingen in de retailsector.

Le POKER Q est un système de ligne modulaire avec un câblage traversant prémonté. Le niveau de finition, les différentes optiques (60°, 90° et asymétriques) ainsi que la possibilité de combiner des spots orientables en font une solution intéressante pour les applications dans le secteur du retail.

POKER Q LS LED



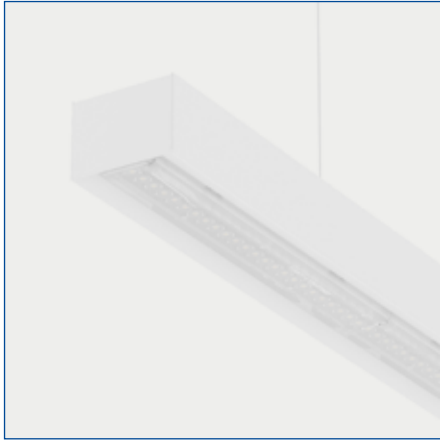

POKER Q LS LED

ALGEMEEN / GÉNÉRALITÉS

TYPE pendel / suspendu

MATERIAL aluminium

DIFFUSER opaal

OPTION other beam options: 60° | Asymm. | Retail (double asymm.)

KENMERKEN / CARACTÉRISTIQUES

W	L	CT	Lm	Beam	COLOUR	€ PRICE
18W	1132 mm	3000K 4000K	2940	90°	☐	111
25W	1132 mm	3000K 4000K	3960	90°	☐	111
38W	1132 mm	3000K 4000K	5520	90°	☐	126
54W	1132 mm	3000K 4000K	7175	90°	☐	126
37W	1692 mm	3000K 4000K	5935	90°	☐	133
55W	1692 mm	3000K 4000K	8280	90°	☐	152
78W	1692 mm	3000K 4000K	10760	90°	☐	158
61W	2812 mm	3000K 4000K	9890	90°	☐	182
88W	2812 mm	3000K 4000K	13800	90°	☐	211
130W	2812 mm	3000K 4000K	17930	90°	☐	219



option 90-60°
asym

L80B10
>72.000h

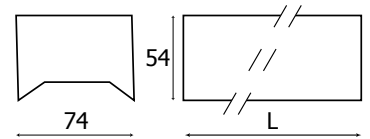



36 GEOMETRIC ARC LED

De **GEOMETRIC ARC LED** vervolledigt de GEOMETRIC-reeks en geeft een speels aspect aan de ruimte. Deze unieke vormgeving wordt gecombineerd met technisch sterke aspecten en een output tot 7200 Lm waardoor de GEOMETRIC ARC wel degelijk ontworpen is om de algemene verlichting in een ruimte te voorzien.

UPDATE

Le **GEOMETRIC ARC LED** complète la série GEOMETRIC et donne un aspect ludique à l'espace. Cette conception unique, combinée à des atouts techniques et à une puissance allant jusqu'à 7200 Lm, en font un appareil bien conçu pour fournir un éclairage général dans une pièce.

GEOMETRIC ARC
LED





GEOMETRIC ARC LED

ALGEMEEN / GÉNÉRALITÉS

TYPE	pendel / suspendu
MATERIAL	staalplaat gepoederlakt / tôle d'acier peinte en poudre
DIFFUSER	OPAL
OPTION	dimming: DALI

KENMERKEN / CARACTÉRISTIQUES

INFO	W	CT	Lm	COLOUR	€ PRICE
1/2-Ring-180°	45W	3000K 4000K	4360 4490	■	431
1/2-Ring-180°	70W	3000K 4000K	7060 7270	■	532
1/4-Ring-90°	60W	3000K 4000K	6020 6280	■	477
1/6-Ring-60°	40W	3000K 4000K	3940 4040	■	390
1/8-Ring-45°	30W	3000K 4000K	2910 2990	■	337



L80B10
>72.000h

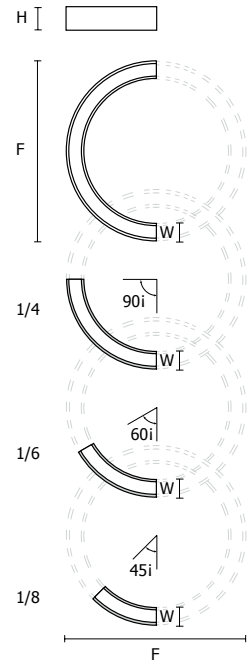

W	H	F
100	62	800
100	62	1200
100	62	2000

ACCESSOIRES

Electrical suspension | Grey, White, Black

Geometric Arc/Line LED End Caps | Grey

Geometric Arc/Line LED set for inline installation | Grey

Simple suspension



37 BEST CLEAN

De opbouw en het ontwerp van de **BEST CLEAN** zorgen voor optimale parameters, zoals een minimale verblinding en een IP65 beschermingsgraad. Het toestel is specifiek ontworpen voor toepassingen in cleanrooms.

La conception et la construction du **BEST CLEAN** garantissent des paramètres optimaux, tels qu'un éblouissement minimum et une protection IP65. L'appareil est spécialement conçu pour les applications en salle blanche.



BEST CLEAN



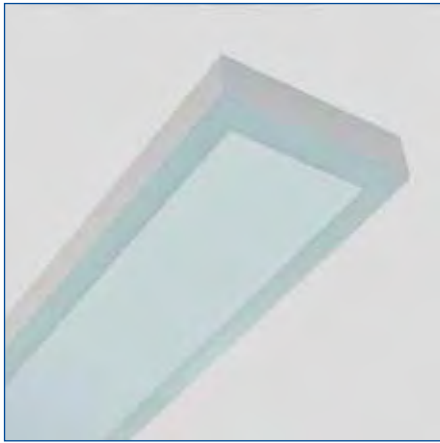

BEST CLEAN LED HR

ALGEMEEN / GÉNÉRALITÉS

TYPE	opbouw plafond / apparent plafond
MATERIAL	staalplaat / tôle d'acier
CT	3000K 4000K 6500K
OPTION	dimming: 1-10V DALI

KENMERKEN / CARACTÉRISTIQUES

TYPE	W	DIMENSIONS	Lm	€ PRICE
SECURITY GLASS + OPAL	39W	350x1250x90	4750	590
SECURITY GLASS + OPAL	54W	350x1250x90	6300	590
SECURITY GLASS + OPAL	49W	350x1515x90	9000	745
SECURITY GLASS + OPAL	99W	350x1515x90	13800	745



L90B20
>50.000h

ACCESSOIRES

Zuignap voor het openen van de armatuur / Ventouse: pour ouvrir le luminaire

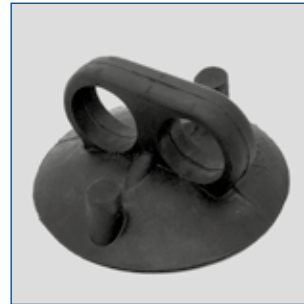



38 LINEA

De **LINEA LED** is een opbouwarmatuur met slagvaste diffuser uit doorzichtig polycarbonaat. Het toestel is IP54 en de lichtsterkte varieert van 2600 tot 8800Lm. Verkrijgbaar met noodverlichting en DALI. De LINEA LED bestaat ook als ronde en vierkante variant.

Le **LINEA LED** est un appareil intérieur apparent, avec un diffuseur en polycarbonate transparent résistant aux chocs. L'appareil est IP54 et le flux lumineux varie de 2600 à 8800Lm. Disponible avec éclairage de secours ou DALI driver. Le LINEA LED est également disponible en forme ronde et carrée.



LINEA





LINEA LED

ALGEMEEN / GÉNÉRALITÉS

TYPE opbouw plafond / apparent plafond

MATERIAL polycarbonaat / polycarbonate

CT 4000K | option: 3000K | 5000K | 6500K

OPTION dimming: DALI

KENMERKEN / CARACTÉRISTIQUES

TYPE	W	Lm	Dimensions	COLOUR	€ PRICE
1.4ft 2600/840	16W	2170	1160 x 109	☐	82
1.4ft 3200/840	20W	2610	1160 x 109	☐	82
1.4ft 4400/840	27W	3650	1160 x 109	☐	84
2.4ft 5200/840	31W	4220	1160 x 159	☐	101
2.4ft 6400/840	37W	5130	1160 x 159	☐	101
2.4ft 8800/840	51W	7140	1160 x 159	☐	106



L90B10
>50.000h

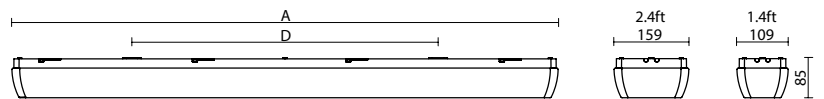

ACCESSOIRES

Beschermingsrooster / Grille de protection





39 NAOS

NEW

De **NAOS** is een universeel opbouwtoestel met lumenoutputs tot 7750Lm. Daarnaast is een versie beschikbaar met microprismatische diffuser.

Door de lage UGR (18,5) is de NAOS MPR zeer geschikt om toe te passen in kantoor- en schoolomgevingen.

Le **NAOS** est un appareil apparent universel avec des flux lumineux jusqu'à 7750Lm. De plus, une version est disponible avec un diffuseur microprismatique.

Grâce à son faible UGR (18,5), le NAOS MPR est parfaitement adapté à une utilisation dans les bureaux et environnement scolaires.

NAOS





NAOS

ALGEMEEN / GÉNÉRALITÉS

TYPE opbouw plafond / apparent plafond

MATERIAL staalplaat / tôle d'acier | PMMA

CT 4000K | option: 3000K | 5000K | 6500K

OPTION dimming: DALI

KENMERKEN / CARACTÉRISTIQUES

TYPE	W	CT	Lm	DIMENSIONS	COLOURS	€ PRICE
1.2ft 1300/840	8W	4000K	1070	620x145	□ ■	142
1.2ft 1600/840	10W	4000K	1880	620x145	□ ■	142
1.4t 2600/840	16W	4000K	2090	1180x145	□ ■	176
1.4ft 3200/840	20W	4000K	2520	1180x145	□ ■	176
1.5ft 3250/840	20W	4000K	2620	1460x145	□ ■	193
1.5ft 4000/840	24W	4000K	3140	1460x145	□ ■	193
2.2ft 2600/840	16W	4000K	2180	620x195	□ ■	159
2.2ft 3200/840	19W	4000K	2580	620x195	□ ■	159
2.4t 5200/840	31W	4000K	4870	1180x195	□ ■	201
2.4ft 6400/840	37W	4000K	5200	1180x195	□ ■	201
2.5ft 6500/840	38W	4000K	5300	1460x195	□ ■	224
2.5ft 8000/840	46W	4000K	6430	1460x195	□ ■	224



option option

L90B10
>50.000h

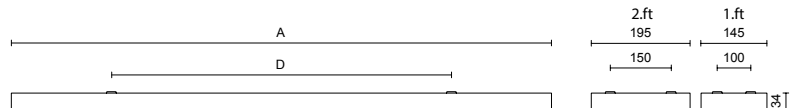

A	D
620	470
1180	1030
1460	1310



40 SPORT LED

Deze toestellen zijn bestemd voor het gebruik in sportzalen waar er risico is op de impact van een bal. De toestellen zijn uitgerust met LED lichtbronnen van Osram, Philips of Samsung naargelang de uitvoering. Alle **SPORT LED** toestellen zijn gemaakt van 0.5 mm dik staal en uitgerust met een beschermingsgrille. Als optie kan een polycarbonaat plexi, aluminium grille of een gepolierde MIRO reflector geplaatst worden om een betere efficiëntie te bereiken. Louvre: wordt verstevigd met 3 stalen draden in een witte kleur. De GRID-uitvoering beschikt over dezelfde eigenschappen als de LOUVRE. Daarnaast is deze versterkt met een extra rooster bovenop de (aluminium) reflector.

Ces luminaires sont destinés à l'usage dans les salles de sport avec un risque de choc à causer par des ballons. Luminaires utilisant la source avancée type LED. Equipé de sources lumineuses led d'Osram, Philips ou Samsung selon les disponibilités. Tous les appareils **SPORT LED** sont fabriqués à partir d'acier de 0,5 mm d'épaisseur et équipés d'une grille de protection. En option, un plexi en polycarbonate, une grille en aluminium ou un réflecteur MIRO poli peuvent être utilisés afin d'obtenir une meilleure efficacité. La version « GRID » présente les mêmes caractéristiques que la version « LOUVRE ». En outre, celle-ci est renforcée avec une grille supplémentaire par-dessus le réflecteur (en aluminium).



SPORT LOUVRE



SPORT GRID





SPORT LED

ALGEMEEN / GÉNÉRALITÉS

TYPE	opbouw plafond / apparent plafond
MATERIAL	staalplaat / tôle d'acier
OPTION	dimming: DALI

SPORT LOUVRE

KENMERKEN / CARACTÉRISTIQUES

W	CT	Lm	DIMENSIONS	COLOUR	€ PRICE
47W	4000K	6251	335x1255x85	□	358
95W	4000K	12065	335x1255x85	□	363
70W	4000K	9662	335x1555x85	□	394
102W	4000K	13496	335x1555x85	□	394
142W	4000K	17986	335x1555x85	□	403
145W	4000K	16710	450x1555x85	□	602
205W	4000K	23546	450x1555x85	□	610



L90B20
>50.000h



SPORT GRID

KENMERKEN / CARACTÉRISTIQUES

W	CT	Lm	DIMENSIONS	COLOUR	€ PRICE
47W	4000K	6125	295x1280x85	□	388
95W	4000K	12495	295x1280x85	□	394
70W	4000K	9075	295x1580x85	□	430
102W	4000K	12840	295x1580x85	□	430
142W	4000K	16934	295x1580x85	□	445
145W	4000K	18215	400x1580x85	□	652
205W	4000K	25401	400x1580x85	□	661



L90B20
>50.000h

41 TORINO AS LED

Verlichtingstoestel met een asymmetrische lichtuitval om verticale oppervlakten te belichten zoals schoolborden of schilderijen. Er zijn 3 versies beschikbaar: opbouw, gependeld en als inbouwtoestel. De **TORINO AS LED** is vervaardigd uit een 0,5 mm dik in wit gepoederlakte staalplaat.

Appareil d'éclairage avec une émission de lumière asymétrique pour éclairer des surfaces verticales telles que des tableaux d'école ou des peintures. Il existe trois versions : apparent, suspendu à l'aide de câbles et encastré. LED de type Osram, Samsung ou Philips. Le corps du luminaire est réalisé en tôle d'acier de 0,5 mm d'épaisseur avec un revêtement en poudre blanc.



TORINO AS LED

ALGEMEEN / GÉNÉRALITÉS

TYPE opbouw plafond / apparent plafond

MATERIAL staalplaat / tôle d'acier

OPTION dimming: DALI

KENMERKEN / CARACTÉRISTIQUES

W	CT	Lm	DIMENSIONS	COLOUR	€ PRICE
17W	3000K 4000K	1580 1600	610x172x80	□	76
32W	3000K 4000K	3280 3350	1170x172x80	□	99



option option

L80B10
>72.000h

ANDERE KLEUREN OP AANVRAAG / AUTRES COULEURS SUR DEMANDE

42 TORINO SPORT LED

NEW

De **TORINO SPORT** is een standaard sporthaltoestel met parabolische reflector en beschermingsgrille.

Le **TORINO SPORT** est un appareil de sport standard avec réflecteur parabolique et grille de protection.

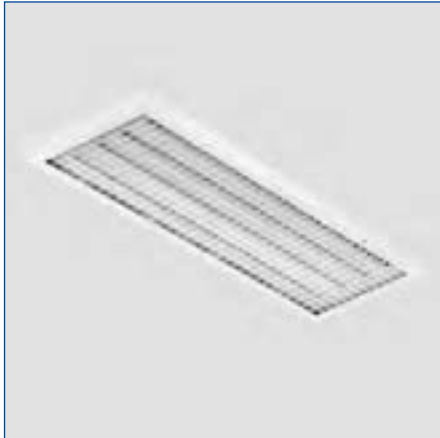

TORINO SPORT LED

ALGEMEEN / GÉNÉRALITÉS

TYPE opbouw plafond / apparent plafond

MATERIAL staalplaat / tôle d'acier

DIFFUSER parabolic louver + prismatic glass

OPTION dimming: DALI

KENMERKEN / CARACTÉRISTIQUES

W	CT	Lm	DIMENSIONS	COLOUR	€ PRICE
50W	3000K	6000	1226x274x65	□	332
50W	4000K	6150	1226x274x65	□	332
100W	3000K	12060	1226x486x65	□	494
100W	4000K	12300	1226x486x65	□	494
145W	3000K	19500	1226x486x65	□	656
145W	4000K	20000	1226x486x65	□	656



L90B10
>52.000h



44 TORINO II IP65 LED

De **TORINO II LED** is een IP65 opbouwtoestel met de afmetingen van een 60x60 cm of 120x30 cm. Het toestel is vervaardigd uit wit gepoederlakt en gegalvaniseerd staal en er zijn zowel matte, opaal, parabolisch als microprismatische diffusers beschikbaar.

Le **TORINO II LED** est un appareil apparent IP65 avec les dimensions d'une dalle de 600x600 cm ou de 1200x300 cm. L'appareil est fabriqué en acier galvanisé revêtu d'une peinture par poudre blanche. Il est disponible avec des diffuseurs mats, opalins, paraboliques ou microprismatiques.



TORINO II IP65 LED

ALGEMEEN / GÉNÉRALITÉS

TYPE	opbouw / apparent
MATERIAL	gepoederlakte staalplaat / tôle d'acier peinte en poudre
DIFFUSER	OPAL microprismatisch / microprismatique MPRM PAR matt gloss MAT
OPTION	dimming: DALI

KENMERKEN / CARACTÉRISTIQUES

DIFFUSER	W	CT	Lm	COLOUR	€ PRICE
OPAL	43W	3000K	3550	☐	257
OPAL	43W	4000K	4070	☐	257
OPAL	43W	3000K	3820	☐	269
OPAL	43W	4000K	3910	☐	269
MPRM	43W	3000K	4580	☐	279
MPRM	43W	4000K	4670	☐	279
MPRM	43W	3000K	4300	☐	297
MPRM	43W	4000K	4390	☐	297
PAR	51W	3000K	6370	☐	334
PAR	51W	4000K	6500	☐	334
PAR	51W	3000K	6370	☐	324
PAR	51W	4000K	6500	☐	324
MAT	43W	3000K	4840	☐	262
MAT	43W	4000K	4940	☐	262
MAT	43W	3000K	4580	☐	273
MAT	43W	4000K	4670	☐	273
OPAL	100W	3000K	9380	☐	377
OPAL	100W	4000K	9560	☐	377



option option

L80B10
>54.000h

L	W	H
600	600	90
300	1200	90

De vermelde prijzen zijn indicatieve brutoprijzen zonder mogelijke opties of meerprijzen.
Deze zijn bedoeld om een vlugge budgettering te kunnen maken of te kunnen inschatten in welke prijsrichting het artikel zich bevindt.
Voor een nauwkeurige prijsofferte/ev. lichtstudie staat ons team ter uwer beschikking.

Les prix indiqués sont des prix bruts indicatifs sans les options possibles ou suppléments de prix.
Le but étant de pouvoir faire une budgétisation rapide ou d'estimer dans quelle échelle de prix l'article se situe.
Notre équipe est à votre disposition pour une offre de prix précise ou une éventuelle étude d'éclairage.

RAILSYSTEMEN | RAILSPOTS
RAILS | SPOTS SUR RAILS



1 ARCANO

NEW

De ARCANO is een 48V-systeem met zowel trimless-, opbouw- en pendelmogelijkheden.

Er zijn drivers (on-off / DALI / Casambi) beschikbaar om extern te plaatsen of om in de rail zelf in te werken.

L'ARCANO est un système 48V avec différentes possibilités d'installations telles que: trimless, apparent ou suspendu.

Des drivers (on-off / DALI / Casambi) sont disponibles pour une installation déportée ou intégrée dans le rail.

ARCANO





SURFACE MOUNTED TRACK

ALGEMEEN / GÉNÉRALITÉS

TYPE track system: surface | suspended

MATERIAL aluminium

KENMERKEN / CARACTÉRISTIQUES

V	L	COLOUR	€ PRICE
DC48V	1 m	□ ■	83
DC48V	2 m	□ ■	150
DC48V	3 m	□ ■	225

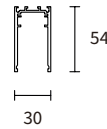

Surface Mounted Track

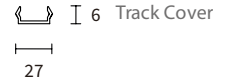

Track Cover

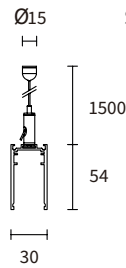

Surface Mounted Track
(with Suspension Kit)

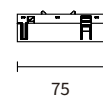

Live End /
Track Connector

ACCESSOIRES



Live End / Track Connector
(connection plate included)



Live End with cable
(3 meter)



L-joint 90°
(connection plates included)



Flexible Track Connector



End Cap



Suspension Kit
(set of 2, 1.5 meter cable)

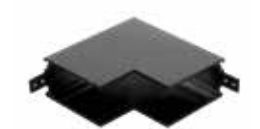

Wall/Wall Connector (in)
(connection plates included)



Wall/Wall Connector (out)
(connection plates included)



Track Cover



RECESSED TRACK

ALGEMEEN / GÉNÉRALITÉS

TYPE track system: recessed

MATERIAL aluminium

KENMERKEN / CARACTÉRISTIQUES

V	L	COLOUR	€ PRICE
DC48V	1 m	□ ■	90
DC48V	2 m	□ ■	169
DC48V	3 m	□ ■	251

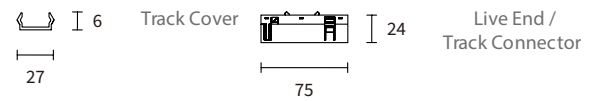
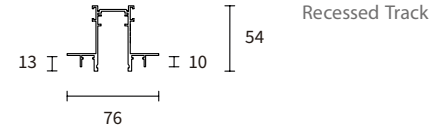

ACCESSOIRES



Live End / Track Connector
(connection plate included)



Live End with cable
(3 meter)



L-joint 90°
(connection plates include d)



Flexible Track Connector



End Cap



Track Cover



Wall/Wall Connector (in)
(connection plates included)



Wall/Wall Connector (out)
(connection plates included)



ADJUSTABLE TRACK LIGHTS SPOTTY

ALGEMEEN / GÉNÉRALITÉS

MATERIAL aluminium

COLOUR

OPTION dimming: DALI

KENMERKEN / CARACTÉRISTIQUES

TYPE	W	CT	Lm	ø (mm)	€ PRICE
Spotty Mini	8W	2700K	401	30	135
Spotty Mini	8W	3000K	446	30	135
Spotty Mini 2-lights	15W	2700K	750	30	218
Spotty Mini 2-lights	15W	3000K	830	30	218
Spotty Medium	14W	2700K	782	52	225
Spotty Medium	14W	3000K	838	52	225
Spotty Medium LH	20W	2700K	1150	52	225
Spotty Medium LH	20W	3000K	1236	52	225
Spotty Maxi	30W	3000K	2250	75	270

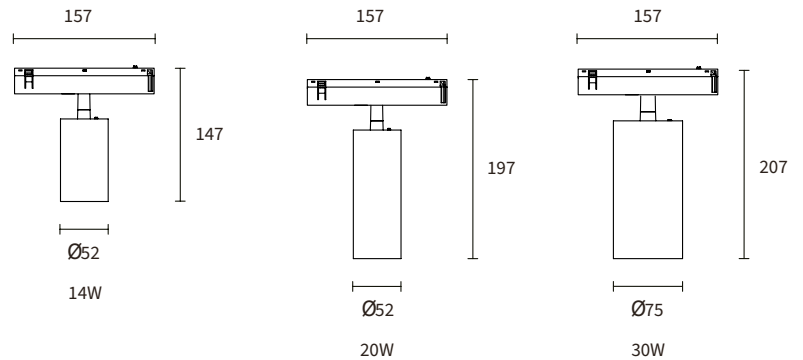
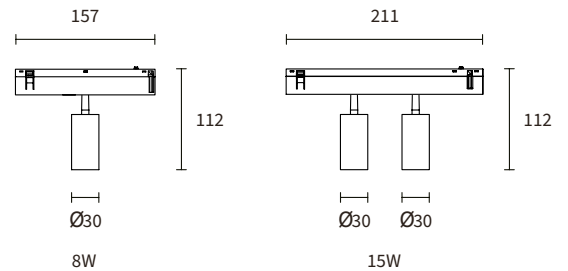

ACCESSOIRES

Available for Ø30 / Ø52 / Ø75 mm tracklights.



50° Lens
for Ø30



15° / 50° Lens
for Ø52 / Ø75



Honeycomb
for Ø52 / Ø75



Golden Inner Ring
for Ø30 / Ø52 / Ø75



RECESSED TRACK SPOT LIGHT TUBY

ALGEMEEN / GÉNÉRALITÉS

MATERIAL aluminium

COLOUR

OPTION dimming: DALI

KENMERKEN / CARACTÉRISTIQUES

TYPE	W	CT	Lm	ø (mm)	€ PRICE
Tuby Mini 2-lights	4W	2700K	265	22	180
Tuby Mini 2-lights	4W	3000K	265	22	180

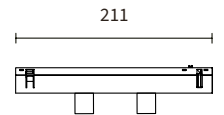

Ø22 Ø22



LINEAR LIGHT (LENS COVER)

ALGEMEEN / GÉNÉRALITÉS

MATERIAL aluminium

COLOUR

OPTIONS dimming: DALI

KENMERKEN / CARACTÉRISTIQUES

TYPE	W	CT	Lm	€ PRICE
Linear light 9-LED	12W	2700K	948	173
Linear light 9-LED	12W	3000K	1047	173

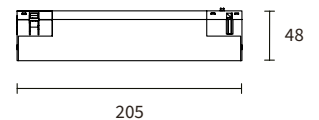



LINEAR LIGHT (LENS COVER)

ALGEMEEN / GÉNÉRALITÉS

MATERIAL aluminium

COLOUR ■

OPTION dimming: DALI

KENMERKEN / CARACTÉRISTIQUES

TYPE	W	CT	Lm	€ PRICE
Linear light 9-LED TILTABLE	11W	2700K	948	263
Linear light 9-LED TILTABLE	11W	3000K	1047	263

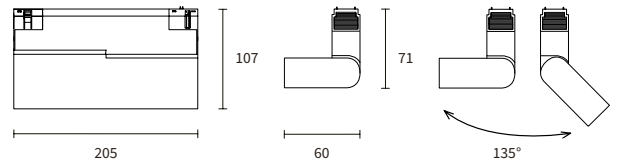

LINEAR LIGHT (OPAL COVER)

ALGEMEEN / GÉNÉRALITÉS

MATERIAL aluminium

COLOUR ■

OPTIONS dimming: DALI

KENMERKEN / CARACTÉRISTIQUES

W	CT	Lm	COVER	€ PRICE
6W	2700K	375	Opal	134
6W	3000K	385	Opal	134
11W	2700K	676	Opal	173
11W	3000K	782	Opal	173
18W	2700K	1340	Opal	248
18W	3000K	1382	Opal	248

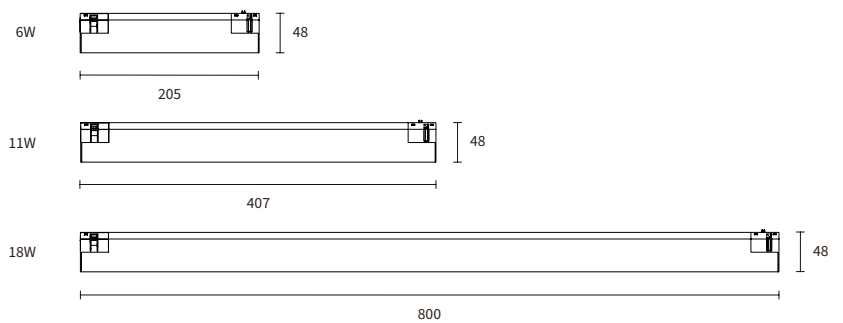





PENDANT BALL TRACK LIGHT

ALGEMEEN / GÉNÉRALITÉS

TYPE track system: trimless | surface | suspended

MATERIAL aluminium

COLOUR ■

OPTION dimming: DALI

KENMERKEN / CARACTÉRISTIQUES

W	CCT	Lm	ø (mm)	COVER	€ PRICE
28W	2700K	2140	180	Opal	330
28W	3000K	2181	180	Opal	330

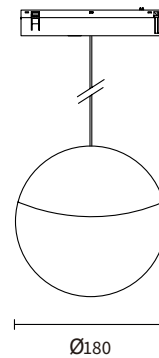

Cable: 2.5m
Cable can be shortened
to desired length.

Tiltable





PENDANT TRACK

ALGEMEEN / GÉNÉRALITÉS

MATERIAL aluminium

COLOUR

KENMERKEN / CARACTÉRISTIQUES

TYPE	W	CT	Lm	ø (mm)	€ PRICE
Mini LH	8W	2700K	267	30	165
Mini LH	8W	3000K	312	30	165
Medium	19W	2700K	1134	52	194
Medium	19W	3000K	1219	52	194

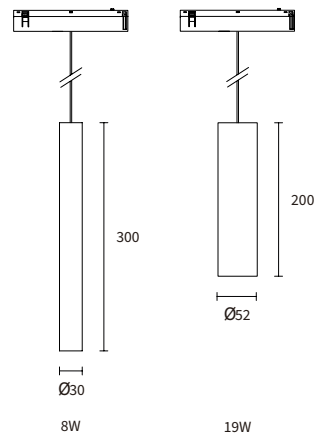

Cable: 2.5m included
Cable can be shortened
to desired length.

ACCESSOIRES



50° Lens
for Ø30



15° / 50° Lens
for Ø52



Golden inner ring
for Ø30 / Ø52



IN-TRACK & REMOTE DRIVERS

ALGEMEEN / GÉNÉRALITÉS

INPUT	230V AC
MATERIAL	aluminium
OUTPUT	48V DC
POWER	max. 600W (DALI max 150W)
OPTION	dimming: DALI



Arcano In-Track-Driver

TYPE	INPUT VOLTAGE	OUTPUT VOLTAGE	OUTPUT POWER	COLOUR	€ PRICE
LED Driver In-track CV Arcano DALI	230 AC	48V DC	Max. 150W	□	563
LED Driver In-track CV Arcano CASAMBI	230 AC	48V DC	Max. 150W	□	713
LED Driver In-track CV Arcano	230 AC	48V DC	Max. 150W	□	548
LED Driver In-track CV Arcano DALI	230 AC	48V DC	Max. 150W	■	563
LED Driver In-track CV Arcano CASAMBI	230 AC	48V DC	Max. 150W	■	713
LED Driver In-track CV Arcano	230 AC	48V DC	Max. 150W	■	548
LED Driver In-track CV Arcano DALI	230 AC	48V DC	Max. 75W	□	563
LED Driver In-track CV Arcano CASAMBI	230 AC	48V DC	Max. 75W	□	713
LED Driver In-track CV Arcano	230 AC	48V DC	Max. 75W	□	548
LED Driver In-track CV Arcano DALI	230 AC	48V DC	Max. 75W	■	563
LED Driver In-track CV Arcano CASAMBI	230 AC	48V DC	Max. 75W	■	713
LED Driver In-track CV Arcano	230 AC	48V DC	Max. 75W	■	548

In-Track Driver (300 cm cable included) | 100W

TYPE	INPUT VOLTAGE	OUTPUT VOLTAGE	OUTPUT POWER	COLOUR	€ PRICE
LED Driver CV Arcano Cable 300 cm	230 AC	48V DC	Max. 100W	■	345
LED Driver In-track CV Arcano	230 AC	48V DC	Max. 100W	□	345

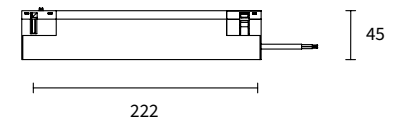



Remote Drivers (30 cm cable included) | up to 450W

TYPE	INPUT VOLTAGE	OUTPUT VOLTAGE	OUTPUT POWER	COLOUR
LED Driver CV Arcano 48V DC 75W Cable 30 cm	230 AC	48V DC	Max. 75W	■
LED Driver CV Arcano 48V DC 100W Cable 30 cm	230 AC	48V DC	Max. 100W	■
LED Driver CV Arcano 48V DC 150W Cable 30 cm	230 AC	48V DC	Max. 150W	■
LED Driver CV Arcano 48V DC 300W Cable 30 cm	230 AC	48V DC	Max. 300W	■
LED Driver CV Arcano 48V DC 480W Cable 30 cm	230 AC	48V DC	Max. 480W	■

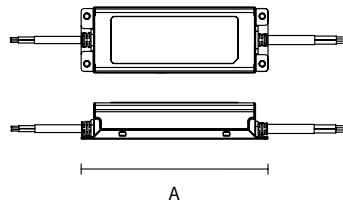

	A	B	C
75W	180	36	63
100W	199	36	63
150W	219	36	63
300W	246	40	77
480W	262	44	125
600W	280	49	144



DALI Dimmable Drivers | up to 150W

TYPE	INPUT VOLTAGE	OUTPUT VOLTAGE	OUTPUT POWER	DALI	COLOUR
LED Driver CV Arcano LCU 48V DC 75W	230 AC	48V DC	Max. 75W	2mA	□
LED Driver CV Arcano LCU 48V DC 150W	230 AC	48V DC	Max. 150W	2mA	□
LED Driver CV Arcano LCU Linear 48V DC 75W*	230 AC	48V DC	Max. 75W	2mA	□
LED Driver CV Arcano LCU Linear 48V DC 150W*	230 AC	48V DC	Max. 150W	2mA	□

Article with * indicates an "open frame" without strain relief

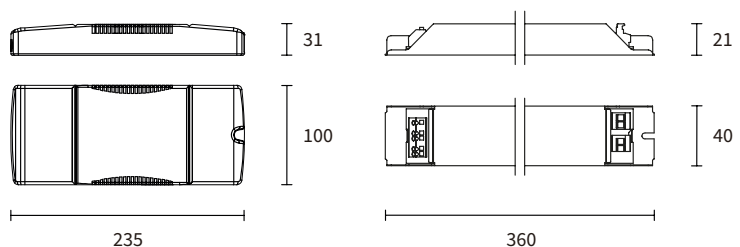

DALI Control Unit

TYPE	INPUT VOLTAGE	OUTPUT CURRENT
DALI Control Unit with intergrated DALI Power Supply	230 AC	Max. 52mA
DALI Control Unit	230 AC	-



- Rated voltage AC 230 V ~
- DALI Output current max. 52mA
- Number of DALI subscribers max. 26
- Max. number of DALI Control Units is 1 x DALI Control Unit with intergrated DALI Power Supply and 3 x DALI Control Unit
- DALI current draw 2mA
- Max. number of DALI Control Units is 1 x DALI Control Unit with intergrated DALI Power Supply and 3 x DALI Control Unit



2 HUB LED

HUB LED

ALGEMEEN / GÉNÉRALITÉS

TYPE	3-fase railarmatuur / armature 3-phasé rail
MATERIAL	gepoedercoat aluminium / alu peinte en poudre
CT	2700 K 3000K 4000K 5000K
OPTION	dimming: DALI Casambi

KENMERKEN / CARACTÉRISTIQUES

W	CT	Lm	COLOUR	€ PRICE
42W	3000K	3915	□ ■ ●	138



L80B10
>50.000h





3 STIO

NEW

STIO

ALGEMEEN / GÉNÉRALITÉS

TYPE	3-fase railarmatuur / armature 3-phasé rail
MATERIAL	aluminium

KENMERKEN / CARACTÉRISTIQUES

W	CT	Lm	COLOUR	€ PRICE
30W	3000K	3528	□ ■ ●	129

-
-
-
-
-
-

L80B10
>34.000h

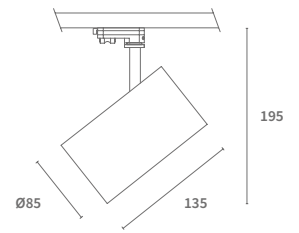



4 TRIGGER CAFETARIA

TRIGGER CAFETARIA

ALGEMEEN / GÉNÉRALITÉS

TYPE	3-fase railarmatuur / armature 3-phasé rail
MATERIAL	gepoedercoat aluminium / alu peinte en poudre
CT	3000K 4000K 5000K
OPTION	dimming: DALI Casambi

KENMERKEN / CARACTÉRISTIQUES

W	CT	Lm	COLOUR	€ PRICE
42W	3000K	3915	□ ■ ●	151



- -
 -
 -
 -
 -
 -
 -
 -
 -
 -
- option 15-20-30-50° option MODULES

L80B10
>50.000h

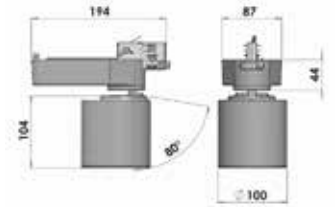



5 SINTRA

SINTRA is een ronde vormgegeven pure spot die door zijn eenvoud zeer populair is. Bestaat in heel veel uitvoeringen waaronder ook de modules om kledij en voeding te belichten.

SINTRA est un pur spot de forme ronde très populaire en raison de sa simplicité. Disponible dans de nombreuses versions, y compris les modules pour éclairer l'alimentation et vêtements.

SINTRA

ALGEMEEN / GÉNÉRALITÉS

TYPE 3-fase railarmatuur / armature 3-phasé rail

MATERIAL gepoedercoat aluminium / alu peinte en poudre

STANDARD dimming: phase cut

KENMERKEN / CARACTÉRISTIQUES

W	CT	Lm	COLOUR	€ PRICE
7W	2700K	674	☐ ■ ●	100
7W	3000K	722	☐ ■ ●	100
7W	4000K	775	☐ ■ ●	100
15W	2700K	1393	☐ ■ ●	129
15W	3000K	1440	☐ ■ ●	129
15W	4000K	1561	☐ ■ ●	129
27W	2700K	2786	☐ ■ ●	181
27W	3000K	2902	☐ ■ ●	181
27W	4000K	3121	☐ ■ ●	181

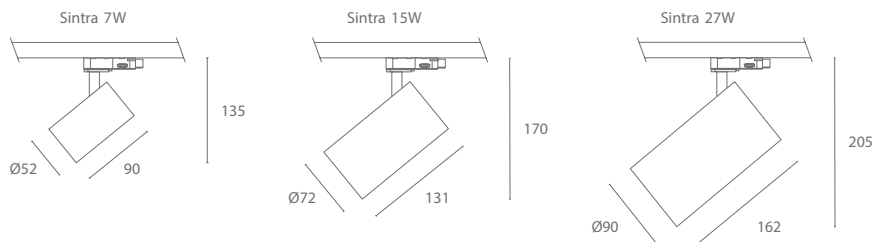

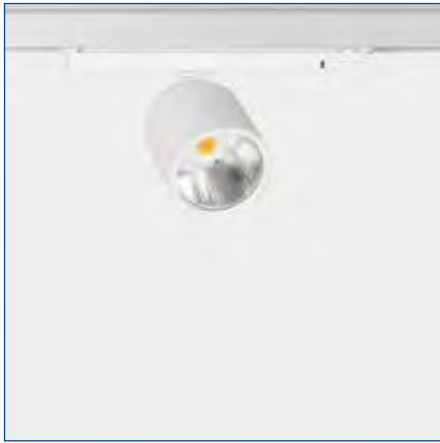

6 GA-016 CASA

GA-016 CASA

ALGEMEEN / GÉNÉRALITÉS

TYPE	3-fase railarmatuur / armature 3-phase rail
MATERIAL	gepoedercoat aluminium / alu peinte en poudre
CT	2700K 3000K 4000K 5000K
OPTION	dimming: DALI Casambi

KENMERKEN / CARACTÉRISTIQUES

W	CT	Lm	COLOUR	€ PRICE
29W	3000K	2938	□ ■ ●	106



L80B10
>50.000h





7 GA-016 LEAN

GA-016 LEAN

ALGEMEEN / GÉNÉRALITÉS

TYPE	3-fase railarmatuur / armature 3-phasé rail
MATERIAL	gepoedercoat aluminium / alu peinte en poudre
CT	2700K 3000K 4000K 5000K
OPTION	dimming: DALI Casambi

KENMERKEN / CARACTÉRISTIQUES

W	CT	Lm	COLOUR	€ PRICE
34W	3000K	3420	□ ■ ●	102



- IP20
- CRI >80
- CRI >90
- DIM option
- 10-20-30-40° option
- MODULES
-
-
-
-

L80B10
>50.000h

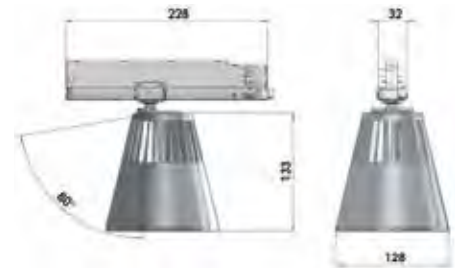



8 GA-016 DINGO

GA-016 DINGO

ALGEMEEN / GÉNÉRALITÉS

TYPE	3-fase railarmatuur / armature 3-phasé rail
MATERIAL	gepoedercoat aluminium / alu peinte en poudre
CT	2700K 3000K 4000K 5000K
OPTION	dimming: DALI Casambi

KENMERKEN / CARACTÉRISTIQUES

W	CT	Lm	COLOUR	€ PRICE
35W	3000K	2908	□ ■ ●	110



L80B10
>50.000h



9 GA-016 BING

GA-016 BING

ALGEMEEN / GÉNÉRALITÉS

TYPE	3-fase railarmatuur / armature 3-phasé rail
MATERIAL	gepoedercoat aluminium / alu peinte en poudre
CT	2700K 3000K 4000K 5000K
OPTION	dimming: DALI

KENMERKEN / CARACTÉRISTIQUES

W	CT	Lm	COLOUR	€ PRICE
25W	3000K	2725	□ ■ ●	110



- IP20
- CRI >80
- CRI >90
- DIM
- 15-21-32-46°
- MODULES
-
-
-
-

L80B10
>50.000h

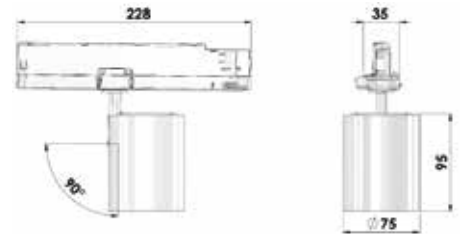



10 GLIDER TREND

NEW

GLIDER TREND

ALGEMEEN / GÉNÉRALITÉS

TYPE 3-fase railarmatuur / armature 3-phasé rail

MATERIAL aluminium

CT 2700K | 3000K | 4000K | 5000K

OPTION dimming: DALI

KENMERKEN / CARACTÉRISTIQUES

W	CT	Lm	COLOUR	€ PRICE
20	3000K	2550	<input type="checkbox"/> <input type="checkbox"/> <input type="checkbox"/>	175
32	3000K	3825	<input type="checkbox"/> <input type="checkbox"/> <input type="checkbox"/>	175
55	3000K	5975	<input type="checkbox"/> <input type="checkbox"/> <input type="checkbox"/>	175



L80B10
>50.000h



11 ARDEA

NEW

De **ARDEA** is een lineair toestel voor 3F-rail montage. Het toestel is beschikbaar met dubbel asymmetrische en 120°-uitstraling wat het toestel geschikt maakt voor retailtoepassingen. Het vermogen is op het toestel instelbaar aan de hand van dipswitches.

L'**ARDEA** est un dispositif linéaire prévu pour montage sur rail 3F. Il est disponible avec un faisceau de 120° ou avec un faisceau double asymétrique, ce qui en fait un appareil particulièrement adapté aux installations dans le secteur du retail. La puissance peut être réglée sur l'appareil à l'aide de DIP switch.

ARDEA





ARDEA OPAAL

ALGEMEEN / GÉNÉRALITÉS

TYPE	3-fase railarmatuur / armature 3 phasé rail
MATERIAL	gepoedercoat aluminium / alu peinte en poudre
CT	3000K 4000K
W	48W 44 W 40W 34W (regelbaar via / réglable par DIP-switches)

KENMERKEN / CARACTÉRISTIQUES

W	Lm	CT	Afmetingen	COLOUR	€ PRICE
afscherming opaal 120°					
48W	5797 6357	3000K 4000K	1150x 65 mm	□ ■	184
dubbel asymmetrisch 25°					
48W	6575 6933	3000K 4000K	1150x 65 mm	□ ■	184



L80B10
>50.000h



ARDEA PANEEL

KENMERKEN / CARACTÉRISTIQUES

W	Lm	CT	Afmetingen	COLOUR	€ PRICE
30° 60° 90°					
70W	10191 11057	3000K 4000K	557x 189 mm	□ ■	254



L80B10
>50.000h



ARDEA SINGLE

KENMERKEN / CARACTÉRISTIQUES

W	Lm	CT	Afmetingen	COLOUR	€ PRICE
30° 60° 90°					
48W	6575 6933	3000K 4000K	1150x 65 mm	□ ■	184



L80B10
>50.000h

12 GLOBAL Trac Pulse Control | DALI

L1/L2/L3/neutral/ground 16 A/400 V
 + control 2 x 1 A/50 FELV AC DALI (FELV),
 KNX, LON, EIB, 1-10 V etc. compatible

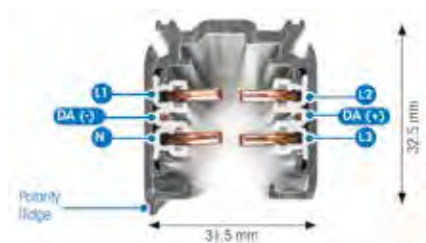
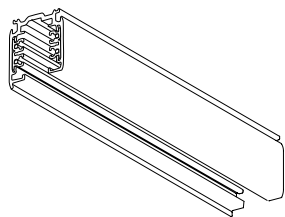

Tool XTSV 12

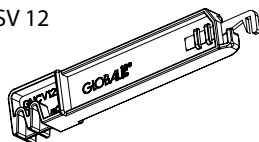

End feed XTSC 611, 612

1. 90 mm, 2. 155 mm

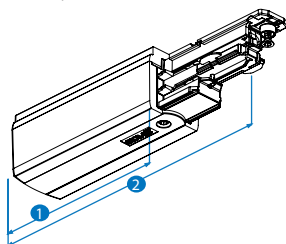

L-feed X TSNC 634, 635

1. 59 mm, 2. 91 mm 3. 156 mm

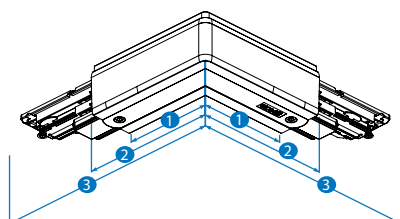

SURFACE MOUNTED TRACKS | XTSC 6100-6400

KENMERKEN / CARACTÉRISTIQUES

TYPE	L (mm)	COLOUR	€ PRICE
XTSC6100	1000	□ ■ ●	44
XTSC6200	2000	□ ■ ●	78
XTSC6300	3000	□ ■ ●	109
XTSC6400	4000	□ ■ ●	141

BENDING TOOL FOR TRACK POWER WIRES

XTSV12	15
--------	----

END FEEDS

TYPE	POLARITY RIDGE	COLOUR	€ PRICE
XTSC611		□ ■ ●	22
XTSC612		□ ■ ●	22

CONNECTORS WITH POWER SUPPLY OPTION

XTSC634		□ ■ ●	50
XTSC635		□ ■ ●	50

T-feed XTSNC 636,637,639,640

1. 280 mm, 2. 150 mm 3. 59 mm
4. 124 mm 5. 91 mm
6. 156 mm

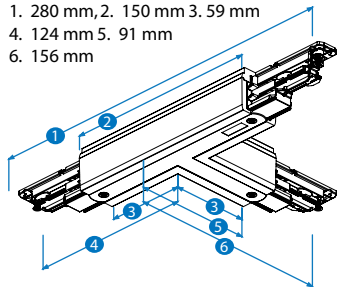

X-feed XTSNC 638

1. 59 mm, 2. 150 mm 3. 280 mm

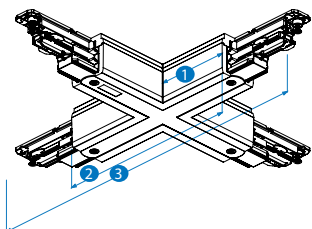

Middle feed X TSNC 614

1. 150 mm, 2. 280 mm

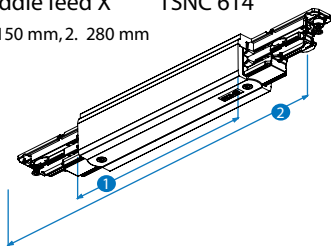

CONNECTORS WITH POWER SUPPLY OPTION

TYPE	POLARITY RIDGE	COLOUR	€ PRICE
XTSC636		<input type="checkbox"/> <input type="checkbox"/> <input checked="" type="checkbox"/>	78
XTSC637		<input type="checkbox"/> <input type="checkbox"/> <input checked="" type="checkbox"/>	78
XTSC639		<input type="checkbox"/> <input type="checkbox"/> <input checked="" type="checkbox"/>	78
XTSC640		<input type="checkbox"/> <input type="checkbox"/> <input checked="" type="checkbox"/>	78
XTSC638		<input type="checkbox"/> <input type="checkbox"/> <input checked="" type="checkbox"/>	107
XTSC614		<input type="checkbox"/> <input type="checkbox"/> <input checked="" type="checkbox"/>	50

Use of L-, T- and X- Feed. Red line indicates polarity ridge

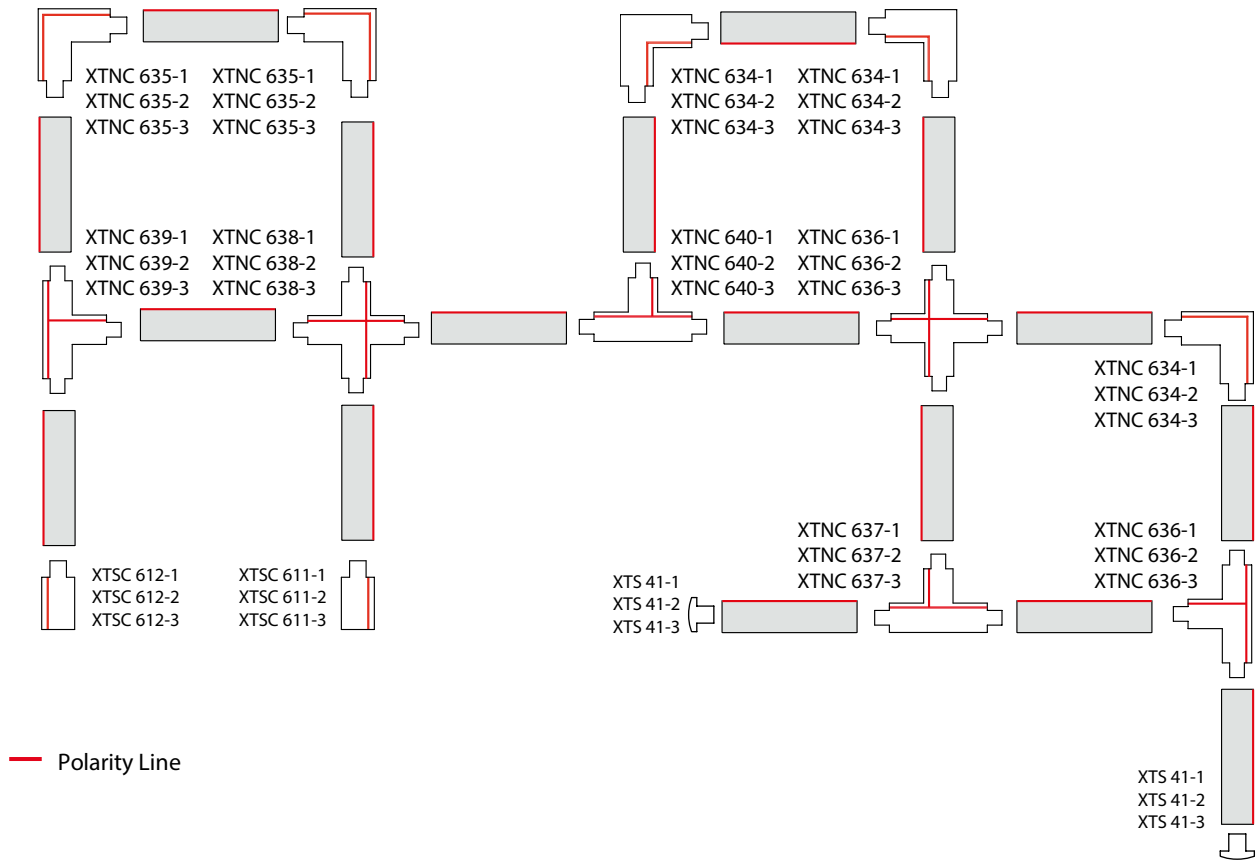

Straight connector

XTSC 621

1. 120 mm

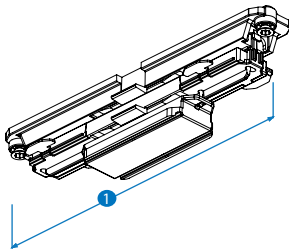

Flexible corner connector

XTSC 623

1. 82 mm, 2. 223 mm,
3. 353 mm

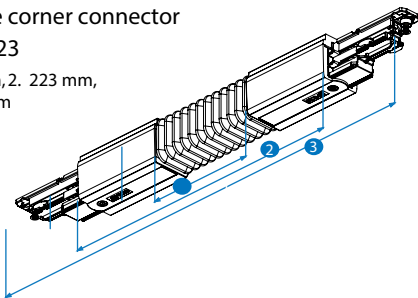

End cap XTS 41

1. 3 mm, 2. 21 mm

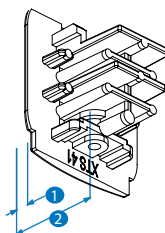

CONNECTORS WITHOUT OPTION FOR POWER SUPPLY

TYPE	COLOUR	€ PRICE
XTSC621	<input type="checkbox"/> <input type="checkbox"/> <input checked="" type="checkbox"/>	20

XTSC623	<input type="checkbox"/> <input type="checkbox"/> <input checked="" type="checkbox"/>	70
---------	---	----

END CAP		
TYPE	COLOUR	€ PRICE
XTS41	<input type="checkbox"/> <input type="checkbox"/> <input checked="" type="checkbox"/>	2,0

13 GLOBAL Trac Pro

L1/L2/L3/neutral/ground 16 A/400 V. IP20.

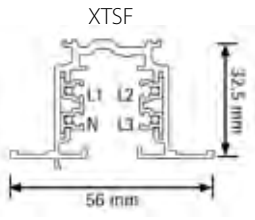
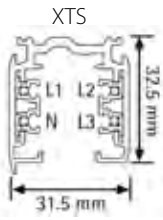
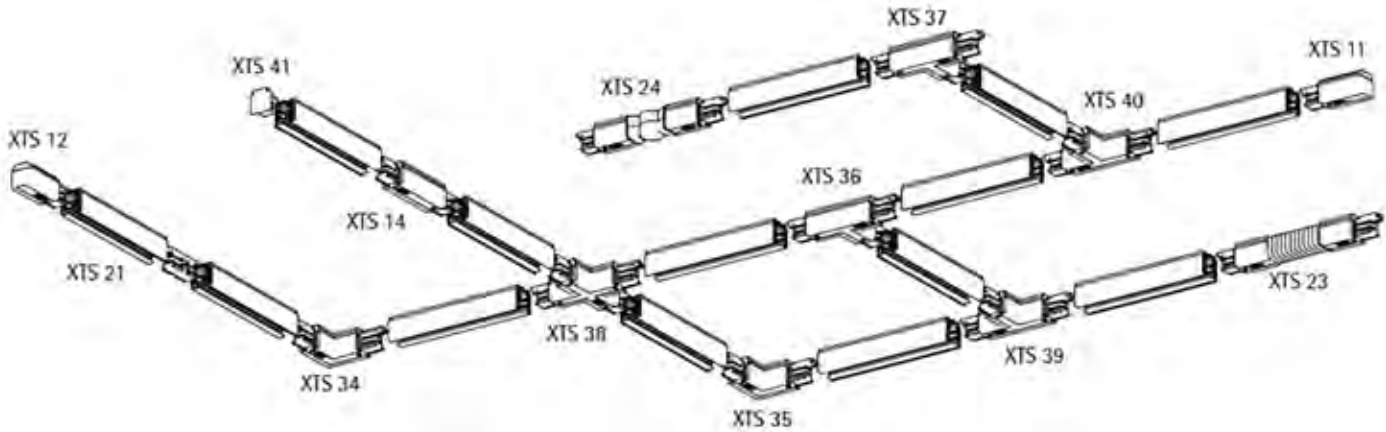

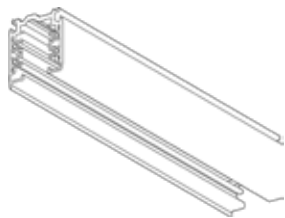

SURFACE MOUNTED TRACKS | XTS 4100-4400

KENMERKEN / CARACTÉRISTIQUES

TYPE	L (mm)	COLOUR	€ PRICE
XTS 4100	1000	□ ■ ■	29
XTS 4200	2000	□ ■ ■	59
XTS 4300	3000	□ ■ ■	99
XTS 4400	4000	□ ■ ■	113

End feed
XTS 11



XTS 12

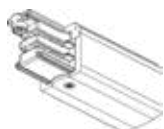

CONNECTORS

TYPE	COLOUR	€ PRICE
XTS 11	□ ■ ■	15
XTS 12	□ ■ ■	15

Middle feed
XTS 14



Straight connector
XTS 21

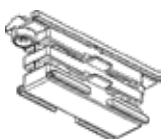

Flexible corner
connector
XTS 23



Adjustable corner
connector
XTS 24



L-feed
XTS 34, 35



T-feed
XTS 36, 37, 39, 40

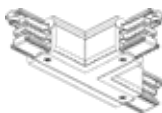

X-feed
XTS 38



End cap
XTS 41

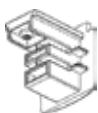

TYPE	COLOUR	€ PRICE
XTS 14	□ ■ ■	35
XTS 21	□ ■ ■	9
XTS 23	□ ■ ■	49
XTS 24	□ ■ ■	41
XTS 34	□ ■ ■	26
XTS 35	□ ■ ■	26
XTS 36	□ ■ ■	37
XTS 37	□ ■ ■	37
XTS 39	□ ■ ■	37
XTS 40	□ ■ ■	37
XTS 38	□ ■ ■	53
XTS 41	□ ■ ■	2

Track suspension
SPW 1



Track suspension
SPW 50



Track suspension
SPW 65



Track suspension
SKB 34

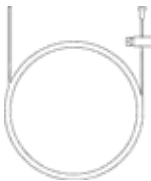

SUSPENSION PARTS

TYPE	LENGTH	COLOUR	€ PRICE
SPW-1	1,5 m	□ ■ ■	11
SPW-1/3M	3 m	□ ■ ■	12
SPW-1/5M	5 m	□ ■ ■	15
SPW50-1	50 m	■	37
SPW65-1	1,5	■	7
SKB34-1	1,5	■	6
SKB34-1/3M	3	■	7
SKB34-1/5M	5	■	8

SUSPENSION PARTS			
	TYPE	COLOUR	€ PRICE
Mounting accessory SKB 30	SKB30	□ ■ ■	14
Rod suspension SPW 66	SPW 66-1	■	4
Rod suspension SPW 40	SPW 40-1	■	16
Rod suspension SKB 40	SKB40-1	■	8
Rod suspension SPR 61	SPR 61-2	■	11
Rod suspension SPR 6	SPR 6-2	■	11
Point clamp SP 4R	SP4R	■	14
Track clamp SKB 21	SKB21	■	4
Track clamp SKB 18	SKB18	■	8



SUSPENSION PARTS

Track clamp
SKB 16



TYPE	COLOUR	€ PRICE
SKB16	□ ■ ■	3

Track clamp
SKB 12 H



SKB12H-1	□ ■ ■	2
----------	-------	---

Track clamp
SKB 12

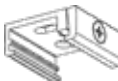

SKB12	□ ■ ■	2
-------	-------	---

Track clamp
SKB W



SKB11WL	□ ■ ■	12
---------	-------	----

Track clamp
SKB 11 T



SKB11T-1	□ ■ ■	5
----------	-------	---

Track clamp
SKB 11 R



SKB11R-1	□ ■ ■	6
----------	-------	---

Track clamp
SKB 10



SKB10	□ ■ ■	3
-------	-------	---

ANDERE ACCESSOIRES / AUTRES ACCESSOIRES

Hook Base
XTAK 142



TYPE	COLOUR	€ PRICE
XTAK 142-1	■	1
XTAK 142-2	■	1
XTAK 142-3	□	1

Hook Base
XTAK 144



XTAK 144-1	■	1
XTAK 144-2	■	1
XTAK 144-3	□	1

Hook Base
XTAK 146



XTAK146-1	■	1
XTAK146-2	■	1
XTAK146-3	□	1

Hook XTAK 11



XTAK11-1	■	1
----------	---	---

Tool XTSV 12



XTSV 12	■	14
---------	---	----

Cover plate
XTSF 10



XTSF 10-1	■	3
XTSF 10-1	■	3
XTSF 10-1	□	3

Cover plate
XTSF 30

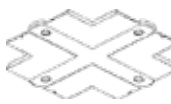

XTSF30-1	■	3
XTSF30-2	■	3
XTSF30-3	□	3

Cover plate
XTSF 40



XTSF40-1	■	3
XTSF40-2	■	3
XTSF40-3	□	3

Cover strip
XTSP 11



XTSP11-2	■	3
XTSP11-3	□	3

De vermelde prijzen zijn indicatieve brutoprijzen zonder mogelijke opties of meerprijzen.
Deze zijn bedoeld om een vlugge budgettering te kunnen maken of te kunnen inschatten in welke prijsrichting het artikel zich bevindt.
Voor een nauwkeurige prijsofferte/ev. lichtstudie staat ons team ter uwer beschikking.

Les prix indiqués sont des prix bruts indicatifs sans les options possibles ou suppléments de prix.
Le but étant de pouvoir faire une budgétisation rapide ou d'estimer dans quelle échelle de prix l'article se situe.
Notre équipe est à votre disposition pour une offre de prix précise ou une éventuelle étude d'éclairage.

OUTDOOR
EXTERIEUR



1 TAG 110 | TAG 210

De **TAG 110** is een esthetische muurstraler met een residentieel karakter. Het toestel beschikt over een dubbele ingang om te voeden en heeft diverse accessoires beschikbaar om de stralers te bevestigen.

De **TAG WHITE** beschikt over een opaal diffusor welke het strakke design van de straler extra benadrukt.

De **TAG 210** beschikt over dezelfde eigenschappen als de TAG 110. Een interessante toevoeging is dat de TAG 210 ook met asymmetrische lichtbundel beschikbaar is.

Le **TAG 110** est un projecteur mural esthétique avec un caractère résidentiel. L'appareil dispose d'une double entrée pour l'alimentation. Ici à nouveau, nous avons divers accessoires disponibles afin de pouvoir installer les appareils.

Le **TAG WHITE** dispose d'un diffuseur opale blanc qui accentue le design minimaliste de ce projecteur.

Le **TAG 210** dispose des mêmes caractéristiques que le TAG 110. Un détail supplémentaire intéressant est l'existence d'un TAG 210 avec un faisceau asymétrique.

TAG





TAG 110

ALGEMEEN / GÉNÉRALITÉS

TYPE straler / projecteur

MATERIAL aluminium

DIFFUSER transparant glas / verre transparent

KENMERKEN / CARACTÉRISTIQUES

W	CT	Lm	COLOR	€ PRICE
10W	2700K 3000K 4000K	672 Lm	□ ■ ■ ■	91

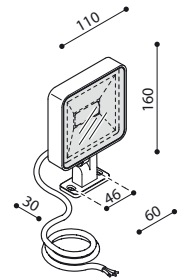

TAG 110 WHITE

ALGEMEEN / GÉNÉRALITÉS

TYPE straler / projecteur

MATERIAL aluminium

DIFFUSER wit melglas / verre matt blanc

KENMERKEN / CARACTÉRISTIQUES

W	CT	Lm	COLOR	€ PRICE
10W	2700K 3000K 4000K	473 Lm	□ ■ ■ ■	91

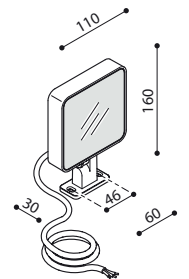



TAG 210

ALGEMEEN / GÉNÉRALITÉS

TYPE straler / projecteur

MATERIAL aluminium

DIFFUSER transparant glas / verre transparent

KENMERKEN / CARACTÉRISTIQUES

W	CT	Lm	COLOR	€ PRICE
25W	2700K 3000K 4000K	2585	<input type="checkbox"/> <input type="checkbox"/> <input type="checkbox"/> <input type="checkbox"/>	173

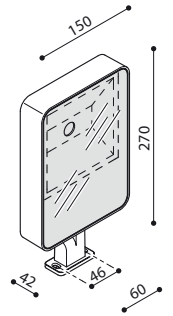

TAG 210 WHITE

ALGEMEEN / GÉNÉRALITÉS

DIFFUSER melkglas / verre blanc matt

KENMERKEN / CARACTÉRISTIQUES

W	CT	Lm	COLOR	€ PRICE
25W	2700K 3000K 4000K	1808	<input type="checkbox"/> <input type="checkbox"/> <input type="checkbox"/> <input type="checkbox"/>	173

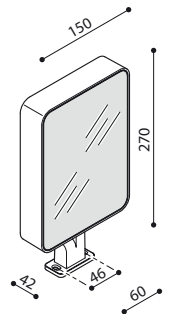



TAG 210 AS

KENMERKEN / CARACTÉRISTIQUES

W	CT	Lm	COLOR	€ PRICE
25W	2700K 3000K 4000K	2386	<input type="checkbox"/> <input type="checkbox"/> <input type="checkbox"/> <input type="checkbox"/>	185

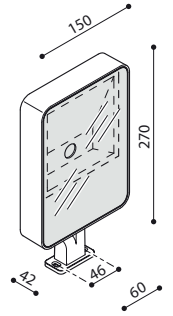



KIT TAG BOX

ALGEMEEN / GÉNÉRALITÉS

TYPE TAG + box

MATERIAL aluminium

DIFFUSER transparant glas / verre transparent

KENMERKEN / CARACTÉRISTIQUES

TYPE	W	CT	Lm	COLOR	€ PRICE
Kit-01 Tag 110 Box	10W	2700K 3000K 4000K	672	<input type="checkbox"/> <input type="checkbox"/> <input type="checkbox"/> <input type="checkbox"/>	157
Kit-02 Tag 210 Box	25W	2700K 3000K 4000K	2585	<input type="checkbox"/> <input type="checkbox"/> <input type="checkbox"/> <input type="checkbox"/>	239
Kit-03 Tag 210 AS Box	25W	2700K 3000K 4000K	2386	<input type="checkbox"/> <input type="checkbox"/> <input type="checkbox"/> <input type="checkbox"/>	250

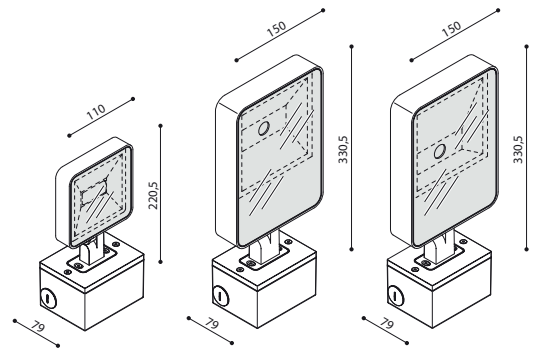

Kit-01 Tag 110 Box Kit-02 Tag 210 Box Kit-02 Tag 210 AS Box





KIT TAG POST

ALGEMEEN / GÉNÉRALITÉS

TYPE TAG + adapter post / adaptateur pour poteau ø 60 mm

KENMERKEN / CARACTÉRISTIQUES

TYPE	W	CT	Lm	COLOR	€ PRICE
Kit-07 Tag 110 Post	10W	2700K 3000K 4000K	672	<input type="checkbox"/> <input type="checkbox"/> <input type="checkbox"/> <input type="checkbox"/>	107
Kit-08 Tag 210 Post	25W	2700K 3000K 4000K	2585	<input type="checkbox"/> <input type="checkbox"/> <input type="checkbox"/> <input type="checkbox"/>	190
Kit-09 Tag 210 AS Post	25W	2700K 3000K 4000K	2386	<input type="checkbox"/> <input type="checkbox"/> <input type="checkbox"/> <input type="checkbox"/>	201

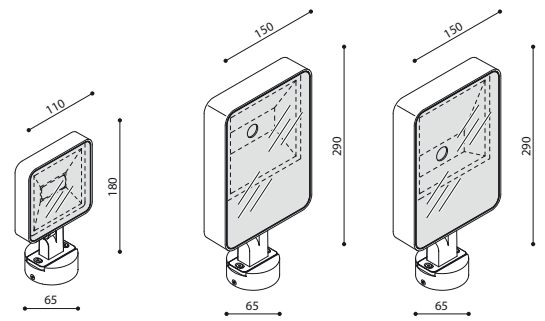

Kit-07 Tag 110 Post Kit-08 Tag 210 Post Kit-08 Tag 210 AS Post



KIT TAG SIDE POST

ALGEMEEN / GÉNÉRALITÉS

TYPE TAG + zijadapter post / adaptateur latéral pour poteau ø 60mm

MATERIAL aluminium

DIFFUSER transparant glas / verre transparent

KENMERKEN / CARACTÉRISTIQUES

TYPE	W	CT	Lm	COLOR	€ PRICE
Kit-19 Tag 110 Side	10W	2700K 3000K 4000K	672	<input type="checkbox"/> <input type="checkbox"/> <input type="checkbox"/> <input type="checkbox"/>	124
Kit-20 Tag 210 Side	25W	2700K 3000K 4000K	2585	<input type="checkbox"/> <input type="checkbox"/> <input type="checkbox"/> <input type="checkbox"/>	206
Kit-21 Tag 210 AS Side	25W	2700K 3000K 4000K	2386	<input type="checkbox"/> <input type="checkbox"/> <input type="checkbox"/> <input type="checkbox"/>	217

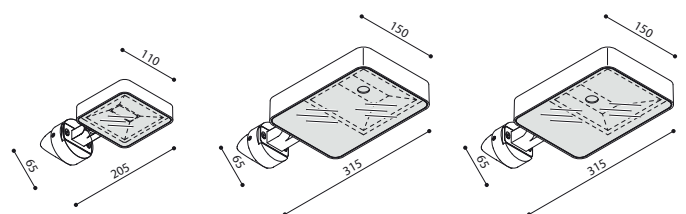

Kit-19 Tag 110 Side Kit-20 Tag 210 Side Kit-21 Tag 210 AS Side



2 CNC

De **CNC** is een kwalitatieve IP68 inbouwspot. Het toestel doet perfect dienst als signalisatie- of accentverlichting. De behuizing is vervaardigd uit inox en gehard glas. De CNC-reeks beschikt over een aansluitkabel van 1,5 m maar kan optioneel uitgerust worden met een rechtstreekse kabel tot 20 m om de waterdichtheid te garanderen.

Opgelet: de driver dient afzonderlijk als optie besteld te worden.

Le **CNC** est un spot de IP68 de qualité. L'appareil fonctionne parfaitement comme éclairage signalétique ou d'accentuation. Le corps est composé d'acier inoxydable et verre trempé. La gamme CNC dispose d'un câble de raccordement de 1,5 m mais peut être équipé, en option, pour garantir l'étanchéité, d'un câble direct allant jusqu'à 20 m.

Attention : le driver doit être commandé séparément en tant qu'option.

CNC





CNC25 T

ALGEMEEN / GÉNÉRALITÉS

TYPE	inbouw muur, plafond, vloer / encastré mur, plafond, sol
MATERIAL	inox
DIFFUSER	transparant glas / verre transparent
OPTIC	15° - 30° - diff.
OPTION	driver: 500mA - 24V (zie pag. / voire page 235)

KENMERKEN / CARACTÉRISTIQUES

W	CT	Lm	COLOR	€ PRICE
2W	2700K 3000K 4000K Blue	148Lm	■ ■ ■	113



1,50 m kabel / câble

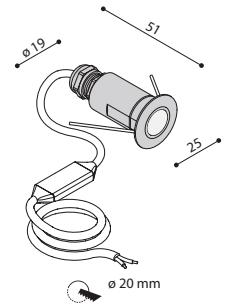

CNC25 Q

ALGEMEEN / GÉNÉRALITÉS

TYPE	inbouw muur, plafond, vloer / encastré mur, plafond, sol
MATERIAL	inox
DIFFUSER	transparant glas / verre transparent
OPTIC	15° - 30° - diff.
OPTION	driver: 500mA - 24V (zie pag. / voire page 235)

KENMERKEN / CARACTÉRISTIQUES

W	CT	Lm	COLOR	€ PRICE
2W	2700K 3000K 4000K Blue	148Lm	■	126



1,50 m kabel / câble

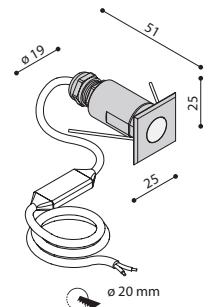



CNC35 T

ALGEMEEN / GÉNÉRALITÉS

TYPE	inbouw muur, plafond, vloer / encastré mur, plafond, sol
MATERIAL	inox
DIFFUSER	transparant glas / verre transparent
OPTIC	14° - 29° - 46° - diff.
OPTION	driver: 500mA - 24V (zie pag. / voire page 235)

KENMERKEN / CARACTÉRISTIQUES

W	CT	Lm	COLOR	€ PRICE
2W	2700K 3000K 4000K Blue	148Lm	■ ■ ■	131

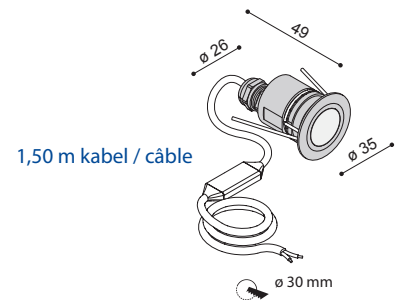

1,50 m kabel / câble



CNC35 Q

ALGEMEEN / GÉNÉRALITÉS

TYPE	inbouw muur, plafond, vloer / encastré mur, plafond, sol
MATERIAL	inox
DIFFUSER	transparant glas / verre transparent
OPTIC	14° - 29° - 46° - diff.
OPTION	driver: 500mA - 24V (zie pag. / voire page 235)

KENMERKEN / CARACTÉRISTIQUES

W	CT	Lm	COLOR	€ PRICE
2W	2700K 3000K 4000K Blue	148Lm	■	142

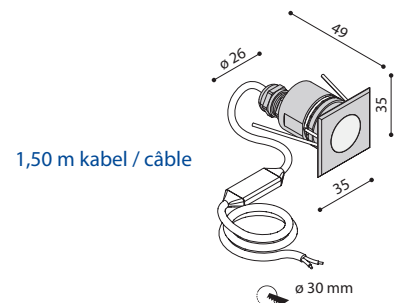

1,50 m kabel / câble



CNC50 T

ALGEMEEN / GÉNÉRALITÉS

TYPE	inbouw muur, plafond, vloer / encastré mur, plafond, sol
MATERIAL	inox
DIFFUSER	transparant glas / verre transparent
OPTIC	12° - 24° - 53° - diff.
OPTION	driver: 500mA - 24V (zie onder / voir ci-dessous)

KENMERKEN / CARACTÉRISTIQUES

W	CT	Lm	COLOR	€ PRICE
6,5W	2700K 3000K 4000K	427Lm	■ ■ ■	182



1,50 m kabel / câble

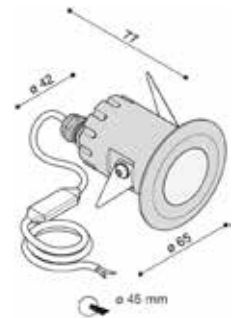

DRIVER OPTIES / OPTIONS DRIVER

	Type CNC 25/35	Type CNC 50	IP	€ PRICE
500mA	1 - 4	1 - 2	IP67	60
500mA	5 - 10	2 - 4	IP67	103
24V	1 - 8	1 - 5	IP67	51
24V	1 - 15	1 - 7	IP67	71

VOEDINGSKABEL / CÂBLE D'ALIMENTATION

standaard / standard : 1,5 m

optie / option : 5 m - 10 m - 15 m - 20 m



CNC 120 T

ALGEMEEN / GÉNÉRALITÉS

TYPE inbouw muur, vloer / encastré mur, sol

MATERIAL aluminium

DIFFUSER gehard en gezeefdrukt glas / verre trempé et sérigraphié

OPTIC spot 25° | 60° | asymm. | diff. | blade

OPTION driver: 700mA - 24V (zie onder / voir ci-dessous)

KENMERKEN / CARACTÉRISTIQUES

W	CT	Lm	COLOR	€ PRICE
9W	2700K 3000K 4000K	750Lm	■	264

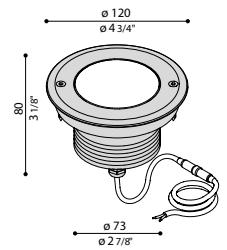

DRIVER OPTIES / OPTIONS DRIVER

	CNC 120 T	IP	€ PRICE
700mA	1 - 2	IP67	63
24V	1 - 4	IP67	51
24V	1 - 6	IP67	71





CNC35 SWING

ALGEMEEN / GÉNÉRALITÉS

TYPE	pinspot / spot de sol
DIFFUSER	transparant glas / verre transparent
MATERIAL	inox
CT	2700K 3000K 4000K Blue
OPTIC	14° 29° 46° Diff.
OPTION	driver: 500mA - 24V (zie pag. / voire page 239)

KENMERKEN / CARACTÉRISTIQUES

W	CT	Lm	COLOR	€ PRICE
2W	2700K 3000K 4000K Blue	148	■ ■ ■	172



L80B10
>70.000h

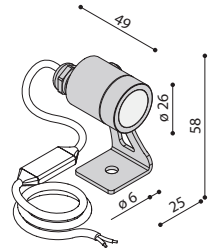

CNC35 SWING SPOT

ALGEMEEN / GÉNÉRALITÉS

TYPE	pinspot / spot de sol
DIFFUSER	transparant glas / verre transparent
MATERIAL	inox
CT	2700K 3000K 4000K Blue
OPTION	driver: 500mA - 24V (zie pag. / voire page 239)

KENMERKEN / CARACTÉRISTIQUES

W	CT	Lm	COLOR	€ PRICE
2W	2700K 3000K 4000K Blue	148	■	182



L80B10
>70.000h

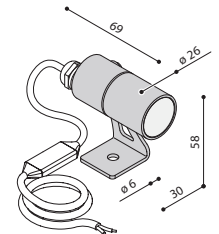



CNC50 SWING

ALGEMEEN / GÉNÉRALITÉS

TYPE	pinspot / spot de sol
DIFFUSER	transparant glas / verre transparent
MATERIAL	inox
OPTIC	13° 24° 53° Diff.
OPTION	driver: 500mA - 24V (zie pag. / voire page 239)

KENMERKEN / CARACTÉRISTIQUES

W	CT	Lm	COLOR	€ PRICE
6,5W	2700K 3000K 4000K Blue	427	■ ■ ■	251



L80B10
>70.000h

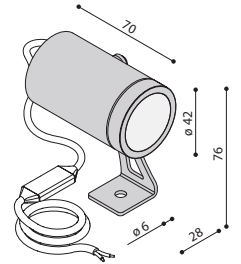

CNC50 SWING SPOT

ALGEMEEN / GÉNÉRALITÉS

TYPE	pinspot / spot de sol
DIFFUSER	transparant glas / verre transparent
MATERIAL	inox
OPTION	driver: 500mA - 24V (zie pag. / voire page 239)

KENMERKEN / CARACTÉRISTIQUES

W	CT	Lm	COLOR	€ PRICE
6,5W	2700K 3000K 4000K Blue	488Lm	■	261



L80B10
>70.000h

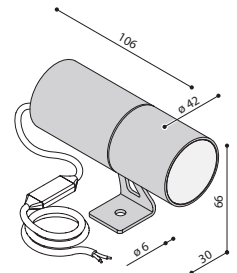

ACCESSOIRES

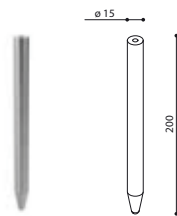

grondpin / piquet de sol
€ 24

voedingskabel standaard / câble d'alimentation standard : 1,5 m

optie / option : 5 m | 10 m | 15 m | 20 m

DRIVER OPTIES / OPTIONS DRIVER

	Type CNC 25/35	Type CNC 50	IP	€ PRICE
500mA	1 - 4	1 - 2	IP67	60
500mA	5 - 10	2 - 4	IP67	103
24V	1 - 8	1 - 5	IP67	51
24V	1 - 15	1 - 7	IP67	71





3 INC 35 | INC 50

NEW

De **INC** is een compacte IP67 grondspot die tevens geschikt is voor wand- en plafondmontage. Het toestel heeft een maximale druklast van 500 kg en is IK10 20J xx9.

De INC is standaard voorzien van een geïntegreerde kabel (1,5 m) en kan optioneel worden uitgerust met een geïntegreerde kabel tot max. 20 meter.

L'**INC** est un spot de sol compact IP67 qui convient également pour un montage au mur ou au plafond. L'appareil peut supporter une charge de maximum 500 kg et est IK10 20J xx9.

L'INC est équipé en standard d'un câble (1,5 m) et peut en option être équipé d'un câble allant jusqu'à 20 mètres.

INC35 | INC 50

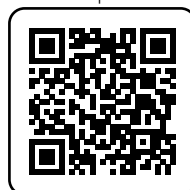



INC 35

ALGEMEEN / GÉNÉRALITÉS

TYPE inbouw muur, vloer / encastré mur, sol

MATERIAL aluminium

DIFFUSER transparant glas / verre trempé

OPTIC 14° | 29° | 46°

OPTION dimming

KENMERKEN / CARACTÉRISTIQUES

W	CT	Lm	COLOR	€ PRICE
2W	2700K 3000K 4000K	120Lm	■ □ ■	126

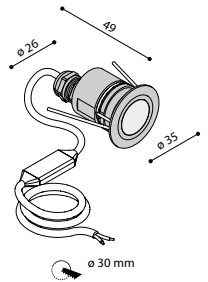

INC 50

ALGEMEEN / GÉNÉRALITÉS

TYPE inbouw muur, vloer / encastré mur, sol

MATERIAL aluminium

DIFFUSER transparant glas / verre trempé

OPTIC 13° | 24° | 53°

OPTION dimming

KENMERKEN / CARACTÉRISTIQUES

W	CT	Lm	COLOR	€ PRICE
6,5W	2700K 3000K 4000K	418Lm	■ □ ■	173

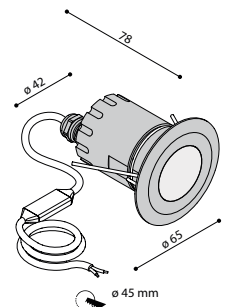



4 KOI 110 POST

De **KOI 110 POST** biedt de mogelijkheid om de KOI toestellen perfect in een balkvormige paal te integreren waardoor de asymmetrische lichteigenschappen ook buiten langs wandelpaden of een oprit perfect tot hun recht kunnen komen.

Le **KOI 110 POST** offre la possibilité d'intégrer parfaitement les appareils KOI dans un poteau rectangulaire, les propriétés lumineuses asymétriques peuvent alors parfaitement se démarquer à l'extérieur le long des sentiers de randonnée ou dans une allée.

KOI 110 POST





KOI 110 POST H400

ALGEMEEN / GÉNÉRALITÉS

TYPE tuinpaal / potelet de jardin

MATERIAL aluminium

DIFFUSER gesatineerd glas / verre effet satiné

KENMERKEN / CARACTÉRISTIQUES

W	CT	Lm	COLOR	€ PRICE
6W	2700K 3000K 4000K	375	<input type="checkbox"/> <input type="checkbox"/> <input type="checkbox"/> <input type="checkbox"/>	271

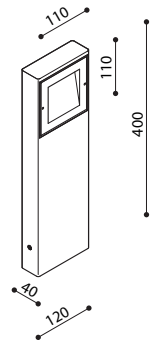

KOI 110 POST H600

KENMERKEN / CARACTÉRISTIQUES

W	CT	Lm	COLOR	€ PRICE
6W	2700K 3000K 4000K	375	<input type="checkbox"/> <input type="checkbox"/> <input type="checkbox"/> <input type="checkbox"/>	304

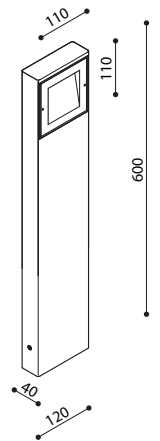



5 KIT LINE POST

De modulaire **KIT LINE POST** bestaat enerzijds uit het lichtgevend element bovenaan met geïntegreerde driver en anderzijds uit een paal vervaardigd uit polycarbonaat met de nodige bevestigingsstukken waarin het toestel inklikt/schuift.

Het toestel bij **KIT 01 & KIT 02** bestaat uit een rondvormige diffusor met dezelfde diameter als de paal. Het licht wordt van onderaan naar boven verspreid door de polycarbonaat behuizing.

Het toestel bij **KIT 03 & KIT 04** bestaat uit dezelfde rondvormige diffusor als bij **KIT 01 & 02**. Het verschil is hier echter dat het licht van boven naar beneden wordt verspreid. Dit zorgt ervoor dat het grondoppervlakte sterker wordt uitgelicht wat bij **KIT 01 & 02** veel minder is. Een bijkomend voordeel is dat er minder verblinding aangezien de ledbronnen bovenaan zijn geïntegreerd en dus naar beneden zijn gericht.

Het toestel bij **KIT 05 & KIT 06** bestaat uit een brede schijf waarbij de leds bovenaan zijn geïntegreerd en dus optimaal het vloeroppervlak uitlichten.

Le **KIT LINE POST** modulaire est composé d'une part d'un élément lumineux au-dessus avec driver intégré et, d'autre part, d'un poteau en polycarbonate avec les éléments de fixation nécessaires pour emboîter l'appareil.

Les appareils **KIT 01 et KIT 02** sont constitués d'un diffuseur rond de même diamètre que le poteau. La lumière est diffusée de bas en haut par le boîtier en polycarbonate.

Les appareils **KIT 03 et KIT 04** sont constitués du même diffuseur de forme ronde que celui du **KIT 01 et 02**. La différence est que la lumière se diffuse de haut en bas. Ce qui garantit une meilleure illumination de la surface au sol, ce qui est bien moindre pour le **KIT 01 et 02**. L'éblouissement plus faible est un avantage supplémentaire puisque les sources LED sont intégrées dans le dessus et donc dirigées vers le bas.

Les appareils **KIT 05 et KIT 06** se composent d'un large disque avec LED intégrés dans le dessus qui éclairent la surface au sol de manière optimale.



KIT-01/03 LINE

ALGEMEEN / GÉNÉRALITÉS

TYPE tuinpaal / potelet de jardin

MATERIAL polycarbonaat / polycarbonate

DIFFUSER polycarbonaat | poliGLASS / polycarbonate | poliGLASS

KENMERKEN / CARACTÉRISTIQUES

KIT	W	CT	COLOR	Lm	H	€ PRICE
01	6,5W	2700K 3000K 4000K	□ ■ ■ ■	604	650	183
03	6,5W	2700K 3000K 4000K	□ ■ ■ ■	604	1650	194

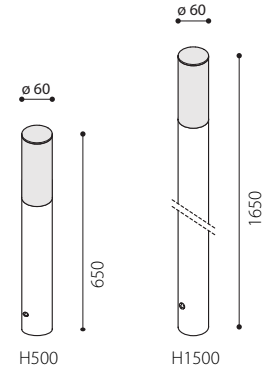

KIT-04/06 LINE DOWN

KENMERKEN / CARACTÉRISTIQUES

KIT	W	CT	COLOR	Lm	H	€ PRICE
04	6W	2700K 3000K 4000K	□ ■ ■ ■	431	650	207
06	6W	2700K 3000K 4000K	□ ■ ■ ■	431	1650	216

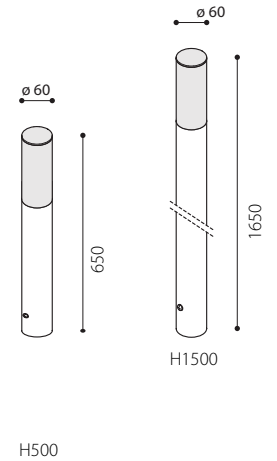

KIT LINE POST







KIT-07/09 LINE 220

ALGEMEEN / GÉNÉRALITÉS

TYPE tuinpaal / potelet de jardin

MATERIAL polycarbonaat / polycarbonate

DIFFUSER polycarbonaat | poliGLASS / polycarbonate | poliGLASS

KENMERKEN / CARACTÉRISTIQUES KIT-05 LINE 220 POST H500

KIT	W	CT	Lm	H	COLOR	€ PRICE
07	11W	2700K 3000K 4000K	910	650	■ ■ ■ ■	191
09	11W	2700K 3000K 4000K	910	1650	■ ■ ■ ■	201

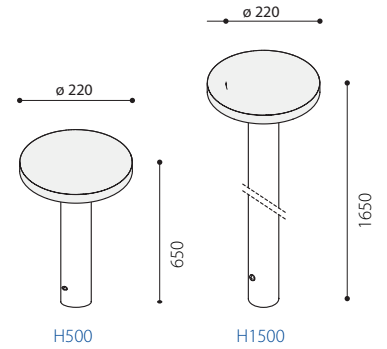



6 LINE 330

De **LINE 330** is ontworpen om dienst te doen als verlichting op parkings, tuinen of andere open vlaktes. Het licht wordt rondom naar beneden verspreid door middel van een polycarbonaat cover.

Le **LINE 330** a été conçu pour l'éclairage de parkings, de jardins ou d'autres espaces ouverts. La lumière est répartie tout autour, et dirigée vers le bas grâce au cache en polycarbonate.

LINE 330





LINE 330

ALGEMEEN / GÉNÉRALITÉS

TYPE tuinpaal / potelet de jardin

MATERIAL aluminium

DIFFUSER polycarbonaat | poliGLASS / polycarbonate | poliGLASS

KENMERKEN / CARACTÉRISTIQUES

W	CT	Lm	COLOR	€ PRICE
25W	2700K 3000K 4000K	2144	■ ■ ■ ■	269

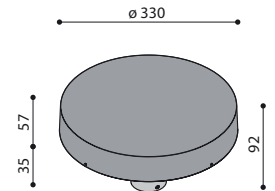

ACCESSOIRES: PALEN / POTEAUS

MATERIAL aluminium

KENMERKEN / CARACTÉRISTIQUES

H (mm)	COLOR	€ PRICE
160	■ ■ ■ ■	47 - 14 - 47 - 47
500	■ ■ ■ ■	52 - 16 - 52 - 52
1000	■ ■ ■ ■	57 - 18 - 57 - 57
1500	■ ■ ■ ■	86 - 28 - 86 - 86
2000	■ ■ ■ ■	124 - 49 - 124 - 124
2500	■ ■ ■ ■	154 - 63 - 154 - 154
3000	■ ■ ■ ■	182 - 70 - 182 - 182
3500	■ ■ ■ ■	211 - 84 - 211 - 211

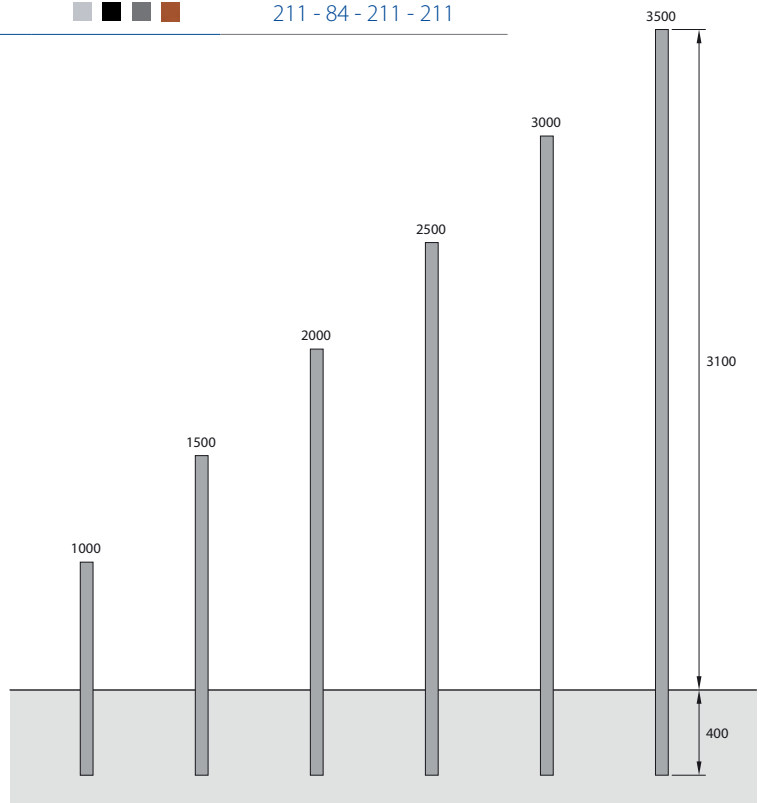



7 GREENLIGHT LED

De **GREENLIGHT LED** is een uit aluminium vervaardigde tuinpaal met geïntegreerde IP65 ledmodule.

De 9W lichtbron volstaat ruimschoots voor het uitlichten van een gangpad, oprit of diverse tuinelementen.

Le **GREENLIGHT LED** est un potelet de jardin en aluminium avec un module LED IP65 intégré.

La source de lumière de 9W suffit pour éclairer un sentier, une allée ou divers éléments de jardin.

GREENLIGHT LED





GREENLIGHT LED 90°

ALGEMEEN / GÉNÉRALITÉS

TYPE	tuinpaal / potelet de jardin
MATERIAL	aluminium
DIFFUSER	opaal mat glas / verre mat opale
COLOR	■

KENMERKEN / CARACTÉRISTIQUES

W	K	Lm	INFO	€ PRICE
9W	3000	480	90° 50x100	193
9W	4000	490	90° 50x100	193

GREENLIGHT LED 115°

KENMERKEN / CARACTÉRISTIQUES

W	K	Lm	INFO	€ PRICE
9W	3000	480	115° 50x60	162
9W	4000	490	115° 50x60	162
9W	3000	480	115° 50x100	190
9W	4000	490	115° 50x100	190

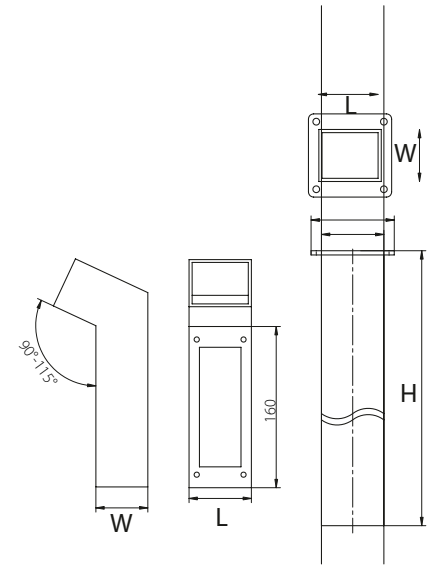

ACCESSOIRES

TYPE	L x W (mm)	H (mm)	COLOR	€ PRICE
paal / poteau	50 x 60	500	■	47
paal / poteau	50 x 60	1000	■	73
paal / poteau	50 x 100	500	■	67
paal / poteau	50 x 100	1000	■	111
paal / poteau	50 x 100	1800	■	180
basis voor montage in beton / base pour montage dans le béton	50 x 60	-	■	29
basis voor montage op grond / base pour montage sur le sol	50 x 100	-	■	31



8 TOK

De **TOK** is een tuinpaaltje die zowel beschikbaar is als ronde en vierkante uitvoering, 180°, 270° of 360° uitstaling. De aluminium behuizing kan voorzien worden van een speciale coating waardoor de TOK geschikt is voor toepassingen aan de kust.

Le **TOK** est un potelet de jardin disponible en rond ou carré, avec un angle d'éclairage de 180°, 270° ou 360°. Le corps en aluminium peut être revêtu d'un traitement spécial adapté aux installations en bord de mer.

TOK





TOK C H150

ALGEMEEN / GÉNÉRALITÉS

TYPE wandmontage, padverlichting / montage murale, éclairage pour allées

MATERIAL aluminium

DIFFUSER transparant PMMA / PMMA transparent

KENMERKEN / CARACTÉRISTIQUES

W	CT	Lm	COLOR	€ PRICE
8W	2700K 3000K 4000K	200	■ ■ ■	248

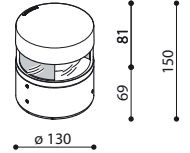

TOK H150

KENMERKEN / CARACTÉRISTIQUES

W	CT	Lm	COLOR	€ PRICE
14W	2700K 3000K 4000K	660	■ ■ ■	248

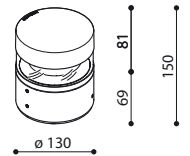

TOK C H400

KENMERKEN / CARACTÉRISTIQUES

W	CT	Lm	COLOR	€ PRICE
8W	2700K 3000K 4000K	200	■ ■ ■	248

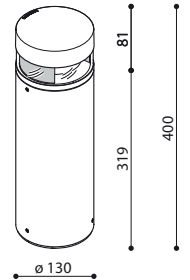



TOK H400

KENMERKEN / CARACTÉRISTIQUES

W	CT	Lm	COLOR	€ PRICE
14W	2700K 3000K 4000K	650	■ ■ ■	264

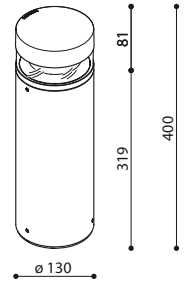

TOK C H700

KENMERKEN / CARACTÉRISTIQUES

W	CT	Lm	COLOR	€ PRICE
6,5W	2700K 3000K 4000K	200	■ ■ ■	311

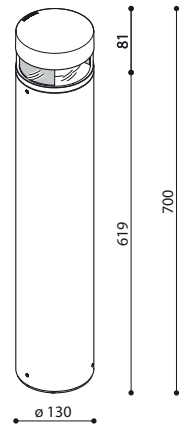

TOK H700

KENMERKEN / CARACTÉRISTIQUES

W	CT	Lm	COLOR	€ PRICE
14W	2700K 3000K 4000K	650	■ ■ ■	311

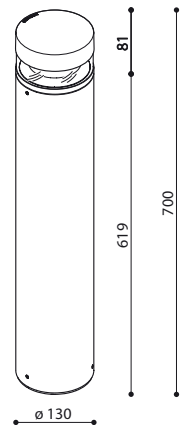



NEW

TOK Q H150

ALGEMEEN / GÉNÉRALITÉS

TYPE	tuinpaal / potelet de jardin
MATERIAL	aluminium
DIFFUSER	transparant kras- & UV-bestendig PMMA / PMMA transparent résistant aux rayures et aux UV
OPTICS	1 x 90° 2 x 90° 4 x 90°

KENMERKEN / CARACTÉRISTIQUES

W	CT	Lm	COLOR	€ PRICE
14W	2700K 3000K 4000K	630	□ ■ ■ ■	271

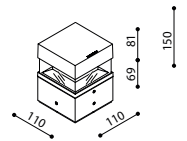

TOK Q H400

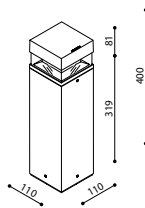

TOK Q H700

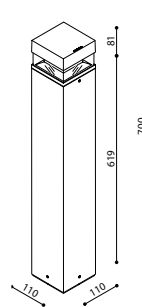

TOK Q H1000

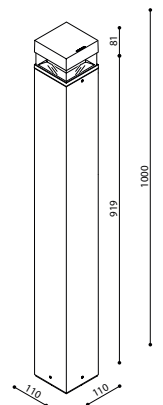

ACCESSOIRES

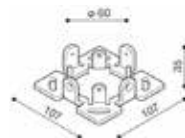

TOK Q stalen bevestigingsbasis / base de montage en acier

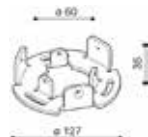

TOK stalen bevestigingsbasis / base de montage en acier



9 TREND 60 POST

De **TREND 60 POST** is een elegant paalarmatuur vervaardigd uit gegoten aluminium behandeld met UV-gestabiliseerde polyesterharscoating. De diffusor is vervaardigd uit gehard glas welke afgedicht is met siliconerubbers. Het toestel is rondom afgedicht met RVS bouten en moeren.

Le **TREND 60 POST** est un potelet élégant en fonte d'aluminium traité avec un revêtement en poudre à base de résines polyesters, fixé aux rayons UV.. Diffuseur en verre trempé scellé avec des joints en silicone. L'appareil est également scellé avec des boulons et écrous en acier inoxydable.

TREND 60 POST





TREND 60 POST H600

ALGEMEEN / GÉNÉRALITÉS

TYPE tuinpaal / potelet de jardin

MATERIAL gegoten aluminium / aluminium moulé

DIFUSSER gehard glas / verre trempé

KENMERKEN / CARACTÉRISTIQUES

W	CT	Lm	COLOR	€ PRICE
3W	2700K	450	□ ■ ● ●	277
3W	3000K	475	□ ■ ● ●	277
3W	4000K	500	□ ■ ● ●	277

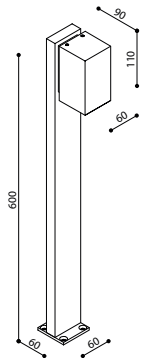

TREND 60 POST H800

KENMERKEN / CARACTÉRISTIQUES

W	K	Lm	COLOR	€ PRICE
3W	2700K	450	□ ■ ● ●	327
3W	3000K	475	□ ■ ● ●	327
3W	4000K	500	□ ■ ● ●	327

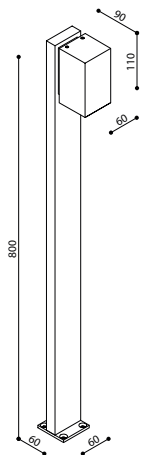

NEW



10 FLAG

NEW

De **FLAG** is een esthetische straler met meerdere bevestigingsmogelijkheden voor zowel wand-, paal- en beugelmontage.

Daarnaast is de aluminium behuizing beschikbaar in verschillende RAL-kleuren met bijhorende accessoires. Ook kan de aluminium behuizing voorzien worden van een epoxybehandeling voor toepassingen aan de kust.

Le **FLAG** est un projecteur esthétique doté de plusieurs options de montage: mural, sur poteau ou bras.

A côté de cela, le corps en aluminium est disponible en différentes couleurs RAL avec accessoires compatibles. Le corps en aluminium peut également être revêtu d'un traitement époxy pour les installations en bord de mer.

FLAG





FLAG 200 REG

ALGEMEEN / GÉNÉRALITÉS

TYPE opbouw / apparent

MATERIAL gegoten aluminium / aluminium moulé

DIFUSSER gehard glas / verre trempé

OPTICS spot 30° | wide | asymm. | diff.

OPTION dimming: DALI

KENMERKEN / CARACTÉRISTIQUES

W	CT	Lm	COLOR	€ PRICE
10W	2700K	1350	□ ■ ● ●	230
10W	3000K	1350	□ ■ ● ●	230
10W	4000K	1350	□ ■ ● ●	230

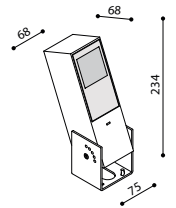

FLAG 200 BOLLARD

KENMERKEN / CARACTÉRISTIQUES

W	K	Lm	COLOR	€ PRICE
10W	2700K	1350	□ ■ ● ●	424
10W	3000K	1350	□ ■ ● ●	424
10W	4000K	1350	□ ■ ● ●	424

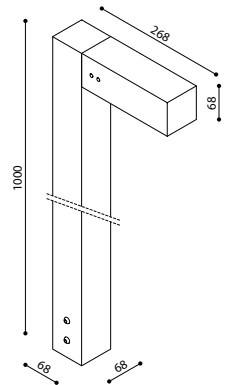



FLAG 330

ALGEMEEN / GÉNÉRALITÉS

TYPE opbouw muur / apparent mur

MATERIAL gegoten aluminium / aluminium moulé

DIFUSSER gehard glas / verre trempé

COLOR

OPTION dimming: DALI

KENMERKEN / CARACTÉRISTIQUES

OPTIC	W	CT	Lm	€ PRICE
SPOT 30°	19W	2200K 2700K 3000K 4000K	2850	240
WIDE	19W	2200K 2700K 3000K 4000K	2850	240
ASYMM	19W	2200K 2700K 3000K 4000K	2850	240
DIFF	19W	2200K 2700K 3000K 4000K	2850	240



L80B20
>70.000h

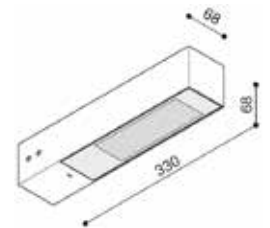

FLAG 430

KENMERKEN / CARACTÉRISTIQUES

OPTIC	W	CT	Lm	€ PRICE
SPOT 32°	35W	2200K 2700K 3000K 4000K	4575	371
WIDE 95°	35W	2200K 2700K 3000K 4000K	4575	371
ASYMM 140°X45°	35W	2200K 2700K 3000K 4000K	4575	371



L80B20
>70.000h

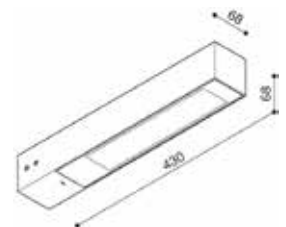





11 AGO BOLLARD

NEW

De **AGO BOLLARD** is een tuinpaal vervaardigd uit geanodiseerd aluminium. Er is zowel een 220V versie (fase afsnijding) als 23V (externe driver / DALI mogelijk) beschikbaar.

L'**AGO BOLLARD** est un potelet de jardin en aluminium anodisé. Une version 220V (coupure de phase) et 24V (driver externe / DALI possible) sont disponibles.

AGO BOLLARD





AGO BOLLARD H300

ALGEMEEN / GÉNÉRALITÉS

TYPE tuinpaal / potelet de jardin

MATERIAL gegoten aluminium / aluminium moulé

DIFUSSER gehard glas / verre trempé

OPTION dimming: DALI

KENMERKEN / CARACTÉRISTIQUES

TYPE	W	CT	Lm	COLOUR	€ PRICE
1L	10W	2700K 3000K 4000K	270	■ ■ ■	340
2L	10W	2700K 3000K 4000K	540	■ ■ ■	340

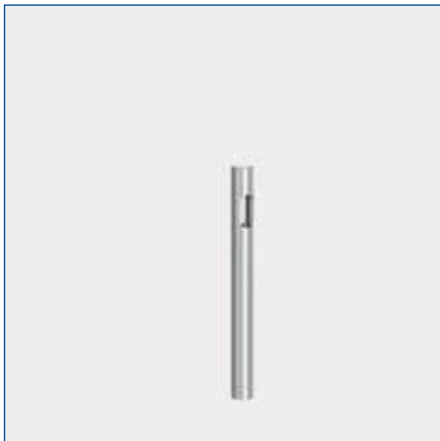
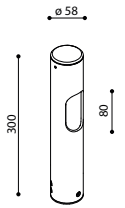

AGO BOLLARD H600

ALGEMEEN / GÉNÉRALITÉS

TYPE tuinpaal / potelet de jardin

MATERIAL gegoten aluminium / aluminium moulé

DIFUSSER gehard glas / verre trempé

OPTION dimming: DALI

KENMERKEN / CARACTÉRISTIQUES

TYPE	W	CT	Lm	COLOUR	€ PRICE
1L	10W	2700K 3000K 4000K	270	■ ■ ■	376
2L	10W	2700K 3000K 4000K	540	■ ■ ■	376

AGO BOLLARD H900

ALGEMEEN / GÉNÉRALITÉS

TYPE tuinpaal / potelet de jardin

MATERIAL gegoten aluminium / aluminium moulé

DIFUSSER gehard glas / verre trempé

OPTION dimming: DALI

KENMERKEN / CARACTÉRISTIQUES

TYPE	W	CT	Lm	COLOUR	€ PRICE
1L	10W	2700K 3000K 4000K	270	■ ■ ■	412
2L	10W	2700K 3000K 4000K	540	■ ■ ■	412

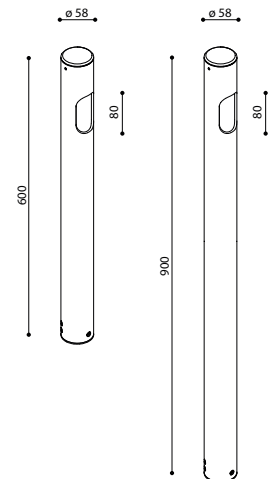



12 AGO GARDEN | WALL

De **AGO** beschikt over gelijkaardige eigenschappen als de CNC maar verschilt behalve qua vorm ook qua behuizingskleuren en stralingshoeken.

L'**AGO** dispose de caractéristiques similaires au CNC mais en diffère au niveau de la forme, des couleurs de finitions et de ses angles d'ouverture.

AGO





AGO GARDEN

ALGEMEEN / GÉNÉRALITÉS

TYPE	pinspot / spot de sol
DIFFUSER	gehard glas / verre trempé
MATERIAL	aluminium
OPTIC	40° 65° diff.

KENMERKEN / CARACTÉRISTIQUES

W	Lm	CT	COLOR	€ PRICE
6W	568	2700K 3000K 4000K	■ ■ ■ ■	143

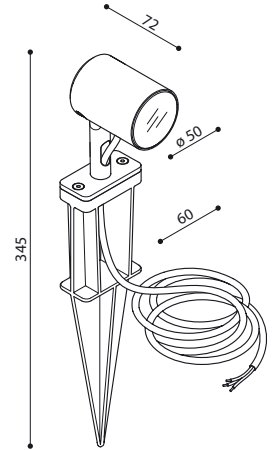

AGO WALL

ALGEMEEN / GÉNÉRALITÉS

TYPE	pinspot / spot de sol
DIFFUSER	gehard glas / verre trempé
MATERIAL	aluminium
OPTIC	40° 65° diff.

KENMERKEN / CARACTÉRISTIQUES

W	Lm	CT	COLOR	€ PRICE
6W	568	2700K 3000K 4000K	■ ■ ■ ■	164



L70B50
>50.000h

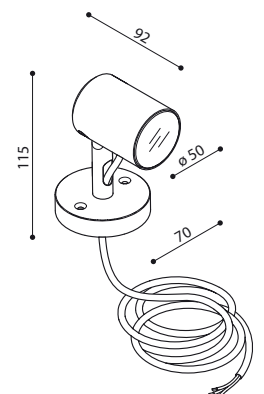

ACCESSOIRES

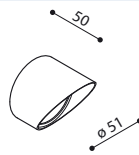

asymmetrische afdekking / casquette asymétrique
€ 28

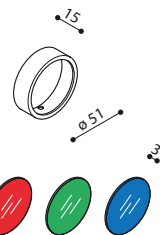

kleurenfilter / filtres colorés
€ 28

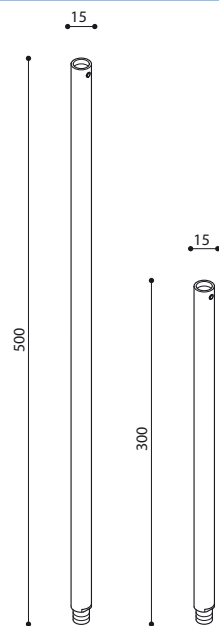

tuinpaal / potelet de jardin
€ 47 - € 80



geïntegreerde kabel van 5 m, 10 m, 15 m, 20 m
(standaard 1,5 m) /
câble de 5 m, 10 m, 15 m, 20 m intégré (standard 1,5 m)





13 KIT TAG GARDEN

De **TAG 110** is een esthetische muurstraler met een residentieel karakter. Het toestel beschikt over een dubbele ingang om te voeden en ook hier opnieuw zijn er diverse accessoires beschikbaar om de stralers te bevestigen.

De TAG 210 beschikt over dezelfde eigenschappen als de Tag 110. Een interessante toevoeging is dat de Tag 210 ook met asymmetrische lichtbundel beschikbaar is.

Le **TAG 110** est un projecteur mural esthétique avec un caractère résidentiel. L'appareil dispose d'une double entrée pour l'alimentation. Ici à nouveau, nous avons divers accessoires disponibles afin de pouvoir installer les appareils.

Le TAG 210 dispose des mêmes caractéristiques que le TAG 110. Un détail supplémentaire intéressant est l'existence d'un TAG 210 avec un faisceau asymétrique.

KIT TAG GARDEN





KIT TAG GARDEN

ALGEMEEN / GÉNÉRALITÉS

TYPE TAG + tuinaccessoire / accessoire de jardin

MATERIAL aluminium

DIFFUSER gehard glas / verre trempé

COLOR

KENMERKEN / CARACTÉRISTIQUES

TYPE	W	CT	Lm	€ PRICE
Kit-04 Tag 110 Garden	10W	2700K 3000K 4000K	672	107
Kit-05 Tag 210 Garden	25W	2700K 3000K 4000K	2585	190
Kit-06 Tag 210 AS Garden	25W	2700K 3000K 4000K	2386	201

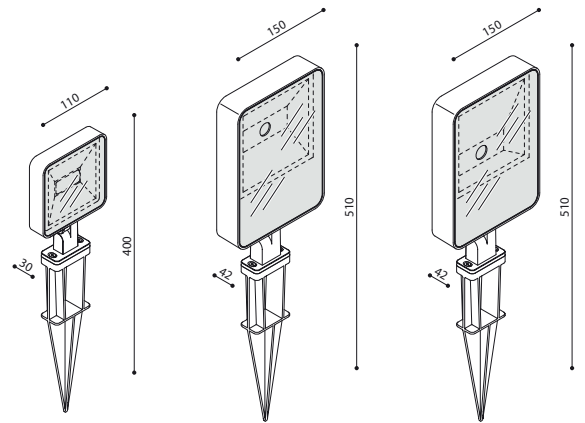

Kit-04 Tag 110 Garden

Kit-05 Tag 210 Garden

Kit-06 Tag 210 AS Garden



14 ANTARES

De behuizing en frame van de **ANTARES** zijn vervaardigd uit gegoten aluminium en afgewerkt met een polyestercoating. Daarnaast is dit toestel voorzien van 4 mm dik gehard glas en zowel symmetrisch als asymmetrisch leverbaar. Gebaseerd op de technische specificaties, gebruikte materialen en onze ervaringen kunnen we besluiten dat dit een kwalitatief uitstekend toestel is.

Le corps et le cadre de l'**ANTARES** sont fabriqués en aluminium moulé revêtu de polyester. A côté de cela, cet appareil est équipé d'un verre trempé de 4 mm d'épaisseur et est disponible en version symétrique ou asymétrique. Sur base des spécifications techniques, des matériaux utilisés et de nos expériences, nous pouvons affirmer qu'il s'agit d'un appareil qualitativement supérieur.

ANTARES

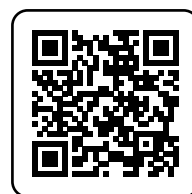



ANTARES

ALGEMEEN / GÉNÉRALITÉS

TYPE	straler / projecteur
MATERIAL	aluminium
DIFFUSER	gehard glas / verre trempé
CT	4000K op aanvraag / sur demande: 2200K 3000K 5700K
OPTION	dimming: DALI 1-10V

KENMERKEN / CARACTÉRISTIQUES

TYPE	W	Lm FLUX	mA	COLOR	€ PRICE
SM	140W	19035	700	■	800
SM	175W	23790	700	■	869
SM	210W	28550	700	■	902
SM	245W	33310	700	■	986
SM	280W	38065	700	■	1015
SM	315W	42823	700	■	1102
AS	140W	18225	700	■	830
AS	175W	22780	700	■	906
AS	210W	27355	700	■	947
AS	245W	31890	700	■	1038
AS	280W	36445	700	■	1075
AS	315W	41000	700	■	1169



option

L80B10
>80.000h



ACCESSOIRES



Paaladapter / Adapteur pour poteau
Ø 40 / 60 mm
53 €



15 PIXEL

De **PIXEL** is verwant aan de hiervoor benoemde ANTARES en geniet dus dezelfde specificaties. Aan de hand van de Pixel-Antaresfamilie kunnen lumenoutputs van 4300 tot 43000 Lm aangeboden worden, zowel met symmetrische als asymmetrische lichtbundel.

Le **PIXEL** est lié à l'Antares cité ci-avant et bénéficie donc des mêmes caractéristiques. Grâce à la famille Pixel-Antares, des flux lumineux de 4300 à 43000 Lm peuvent ainsi être atteints, aussi bien en version symétrique qu'asymétrique.

PIXEL





PIXEL

ALGEMEEN / GÉNÉRALITÉS

TYPE	straler / projecteur
MATERIAL	aluminium
DIFFUSER	gehard glas / verre trempé
CT	4000K op aanvraag / sur demande: 2200K 3000K 5500K
OPTION	dimming: DALI 1-10V

KENMERKEN / CARACTÉRISTIQUES

TYPE	W	Lm FLUX	mA	COLOR	€ PRICE
SM	35W	4760	700	■	344
SM	70W	9520	700	■	387
SM	105W	14275	700	■	427
SM	140W	19035	700	■	455
AS	35W	4560	700	■	352
AS	70W	9115	700	■	409
AS	105W	13670	700	■	450
AS	140W	18225	700	■	486



L80B10
>80.000h

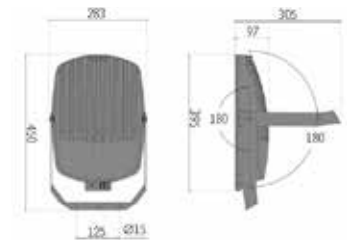

ACCESSOIRES



Paaladapter in horizontale positie / Adapteur pour placement en position horizontale
Ø 40 mm: € 114 / 60 mm: € 114



Paaladapter / Adapteur pour poteau
Ø 40 mm: € 46 / 60 mm: € 46



Dubbele paaladapter / Adapteur double pour poteau
Ø 60 mm



€ 210



Tuinpiek / Pique de jardin



€ 22

Muurstang / Bras pour montage sur mur



16 JOY

De nieuwe **JOY** maakt gebruik van dezelfde materialen als de PIXEL en ANTARES. Het toestel is echter kleiner dan de PIXEL en in tegenstelling tot de PIXEL en ANTARES maakt de JOY gebruik van één enkele COB-LED.

Le nouveau **JOY** a été réalisé avec les mêmes matériaux que le PIXEL et l'ANTARES. Cependant, cet appareil est plus petit, et contrairement au PIXEL et à l'ANTARES, le JOY ne contient qu'un seul LED COB.

JOY

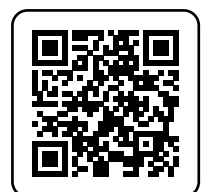



JOY

ALGEMEEN / GÉNÉRALITÉS

TYPE straler / projecteur

MATERIAL aluminium

DIFFUSER gehard glas / verre trempé

CT 4000K | op aanvraag / sur demande: 3000K | 5000K

OPTION dimming: DALI

KENMERKEN / CARACTÉRISTIQUES

W	Lm	mA	COLOR	€ PRICE
10W	1350	350	■	156
21W	3010	700	■	160
32W	4495	900	■	166
37W	5865	1.050	■	174



option

L80B10
>58.000h

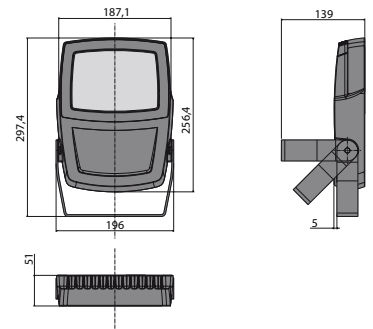

ACCESSOIRES



Paaladapter / Adapteur pour poteau
Ø 40 mm: € 46 / 60 mm: € 46



Tuinpiek / Pique de jardin



€ 22

Muurstang / Bras pour montage sur mur



17 REPLAY

Industriële waterdichte projector, uiterst compact, ideaal voor industriële omgevingen, magazijnen, sportfaciliteiten, zwembaden en productieruimtes. De **REPLAY** is een algemene IP66 straler met een lumenoutput van 13200 tot 22810 Lm. Zowel een beschermrooster, noodeenheid en asymmetrische versie behoren tot de mogelijkheden.

Projecteur industriel étanche, extrêmement compact, idéal pour les environnements industriels, les entrepôts, les installations sportives, les piscines et les zones de production. Le **REPLAY** est un projecteur standard IP66 avec un flux lumineux de 13200 à 22810 Lm. Une grille de protection, une batterie de secours ou une version asymétrique font partie des différentes possibilités d'options.



REPLAY

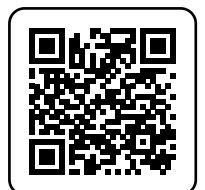



REPLAY

ALGEMEEN / GÉNÉRALITÉS

TYPE	straler / projecteur
MATERIAL	aluminium
DIFFUSOR	transparant methacrylaat / méthacrylate transparent
CT	4000K op aanvraag / sur demande: 3000K 5000K
OPTION	dimming: DALI 1-10V

KENMERKEN / CARACTÉRISTIQUES

W	Lm	mA		COLOR	€ PRICE
99W	14747	700	90°	■	406
138W	18662	950	90°	■	406
184W	24882	950	90°	■	488
99W	15255	700	AS 55°	■	414
138W	19305	950	AS 55°	■	414
184W	25740	950	AS 55°	■	483



L80B10
>58.000h

option

option

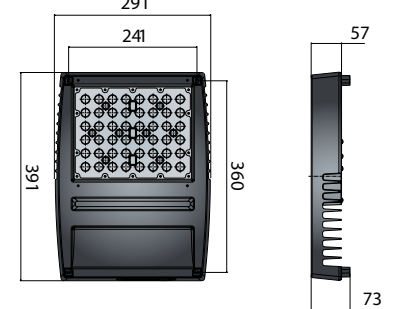

ACCESSOIRES

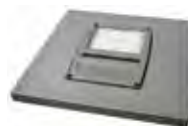

Inbouwkader / Cadre de montage
€ 101



Noodkit / Kit de secours
1h: op aanvraag / sur demande
3h: op aanvraag / sur demande



Rotatiebeugel / Support d'orientation
€ 22



Beschermingsrooster / Grille de protection
€ 20



18 SKYLINE

De **SKYLINE** is een asymmetrische straler ontworpen voor montage op palen. Naast het standaardkleur 4000K is ook 3000K, 5000K evenals DALI-dimming een optie. De lumenoutputs tot 21500 Lm volstaan om parkings, loop pistes, wijken, etc... ruim te gaan uitlichten.

Le **SKYLINE** est un projecteur asymétrique conçu pour être monté sur des poteaux. A côté de la couleur standard 4000K, des options telles que 3000K, 5000K et DALI sont également disponibles. Les flux lumineux allant jusqu'à 25800 Lm conviennent pour éclairer des parkings, terrains de course, quartiers,...

SKYLINE





SKYLINE

ALGEMEEN / GÉNÉRALITÉS

TYPE	straler, mastarmatuur / projecteur, luminaire à mât
MATERIAL	die-cast aluminium
DIFFUSOR	extra helder gehard glas 4 mm / verre trempé extra clair 4 mm
CT	4000K op aanvraag / sur demande: 2200K 3000K 5700K
OPTION	dimming: DALI 1-10V

KENMERKEN / CARACTÉRISTIQUES

W	Lm	mA	COLOR	€ PRICE
35W	4475	700	■	446
70W	8945	700	■	495
105W	13420	700	■	543
140W	17890	700	■	577



option

L80B10
>80.000h

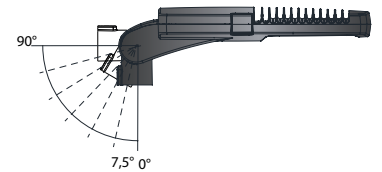
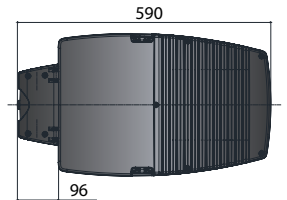
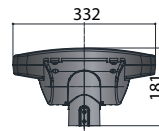
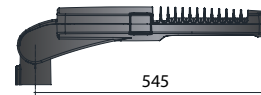

ACCESSOIRES



Paaladapter
Adaptateur de poteau
Ø 40 / 76 mm
€ 56



19 SOUL LED

De **SOUL** beschikt over dezelfde technische componenten en materialen als de SKYLINE. Doordat deze nog beter gekoeld wordt kan deze wattages aan tot 192W / 25800 Lm.

Le **SOUL** possède les mêmes composants techniques et matériaux que le SKYLINE. Grâce à un refroidissement encore plus performant, la puissance peut atteindre 192W pour 25800 Lm.

SOUL LED





SOUL LED

ALGEMEEN / GÉNÉRALITÉS

TYPE straler, mastarmatuur / projecteur, luminaire à mât

MATERIAL die-cast aluminium

DIFFUSOR extra helder gehard glas 4 mm / verre trempé extra clair 4 mm

CT 4000K | op aanvraag / sur demande: 2200K | 3000K | 5700K

OPTION dimming: DALI | 1-10V

KENMERKEN / CARACTÉRISTIQUES

W	Lm	mA	COLOR	€ PRICE
35W	4475	700	■	499
70W	8945	700	■	575
105W	13420	700	■	601
140W	17890	700	■	641
175W	22360	700	■	711



option

L80B10
>80.000h

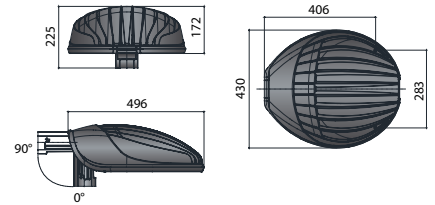



20 ILUMO LED

De **ILUMO LED** is een IP66 wallwasher met een maximumlengte van 1240 mm. Het toestel is erg geschikt om als uplighter een accent te leggen (met 12° reflector) of een muur/object uit te lichten.

L'**ILUMO LED** est un appareil lèche-murs IP66 d'une longueur maximale de 1240 mm. L'appareil est destiné à donner un accent en apportant une lumière provenant du bas (avec un réflecteur de 12°), ou pour mettre en valeur un mur/objet.

ILUMO LED





ILUMO LED

ALGEMEEN / GÉNÉRALITÉS

TYPE wallwasher / lêche-mur

MATERIAL aluminium

DIFFUSER transparant gehard glas / verre trempé transparent

OPTION dimming: DALI | RGB

KENMERKEN / CARACTÉRISTIQUES

W	Lm	CT	L x W x H (mm)		COLOR	€ PRICE
9W	1120	4000K	340 x 64 x 86	12°	■	294
9W	1160	4000K	340 x 64 x 86	20°	■	294
9W	990	4000K	340 x 64 x 86	38°	■	310
16W	2240	4000K	640 x 64 x 86	12°	■	344
16W	2330	4000K	640 x 64 x 86	20°	■	344
16W	1990	4000K	640 x 64 x 86	38°	■	389
23W	3360	4000K	940 x 64 x 86	12°	■	455
23W	3490	4000K	940 x 64 x 86	20°	■	455
23W	2980	4000K	940 x 64 x 86	38°	■	484
30W	4480	4000K	1240 x 64 x 86	12°	■	529
30W	4660	4000K	1240 x 64 x 86	20°	■	529
30W	3560	4000K	1240 x 64 x 86	38°	■	574

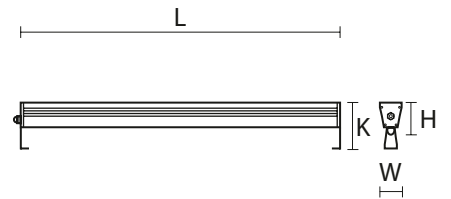



21 APOLLO IP66

NEW

De **APOLLO** is een standaard floodlight met schroefvergrendeling en instelbare beugel tot 270°. De behuizing is vervaardigd uit gegoten aluminium met een cover uit 4mm dik gehard glas.

L'**APOLLO** est un projecteur standard avec un verrouillage à vis et un support réglable jusqu'à 270°. Le boîtier est en fonte d'aluminium avec un couvercle en verre trempé de 4mm d'épaisseur.

APOLLO IP66





APOLLO IP66

ALGEMEEN / GÉNÉRALITÉS

TYPE straler / projecteur

MATERIAL gegoten aluminium / fonte d'aluminium

KENMERKEN / CARACTÉRISTIQUES

W	CT	Lm		COLOR	€ PRICE
100W	4000K	16000	90°	■	255
150W	4000K	24000	90°	■	333
200W	4000K	32000	90°	■	385



L80B20
>100.000h

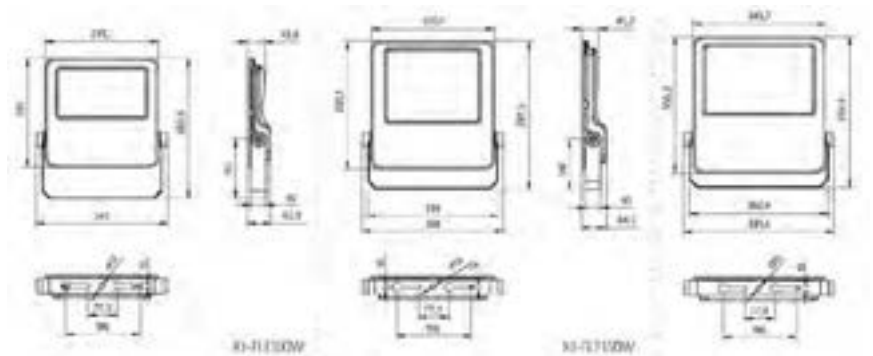



22 MATCH

De **MATCH** is een modulaire schijnwerper met zeer hoog rendement en beperkte verblinding, ontworpen voor de verlichting van sportfaciliteiten.

Het toestel is zeer bestendig tegen chemische en atmosferische invloeden door de behuizing uit thermohardend polyesterpoeder gelakt aluminium die daarnaast ook een fosfochromatiseringsproces onderging.

Le **MATCH** est un projecteur modulaire à très haut rendement et à éblouissement limité, conçu pour l'éclairage des infrastructures sportives. Boîtier en aluminium recouvert de poudre de polyester thermodurcissable, procédé préalablement de phosphochromatisation, qui garantira une résistance extrêmement élevée aux agents chimiques et atmosphériques.



MATCH





MATCH 2 | 240W

MATCH

ALGEMEEN / GÉNÉRALITÉS

TYPE	straler / projecteur
MATERIAL	die-cast aluminium
DIFFUSER	opal PMMA / PMMA opale
OPTICS	15° 24° 40° asymm.
OPTION	dimming: DALI 1-10V

KENMERKEN / CARACTÉRISTIQUES

TYPE	W	CT	Lm	mA	COLOR	A	€ PRICE
MATCH 2	240W	4000K	36950	850	■	AS55	778
MATCH 4	480W	4000K	73900	850	■	AS55	1559
MATCH 6	720W	4000K	110850	850	■	AS55	2426
MATCH 8	960W	4000K	147800	850	■	AS55	3225



L80B10
>100.000h



MATCH 4 | 480W



MATCH 6 | 720W



MATCH 6 | 960W



24 GEMINI PRO

NEW

De **GEMINI** is een compacte straler met verschillende lensmogelijkheden. Zo is er ook een "AS Sport"-versie die een optimale uitstraling biedt voor toepassingen zoals tennis- en padelterreinen.

Le **GEMINI** est un projecteur compact avec différentes options de lentilles. Il existe également une version "AS Sport" qui offre un éclairage optimal pour des applications telles que les terrains de tennis et de padel.

GEMINI PRO





GEMINI PRO

ALGEMEEN / GÉNÉRALITÉS

TYPE	straler / projecteur
MATERIAL	die-cast aluminium
DIFFUSER	opal PMMA / PMMA opale Anti UV
OPTION	dimming: DALI

TYPE	W	CT	Lm	mA	COLOR	€ PRICE
AS 1 - LM 740	24W	4000K	4890	700	■	286
AS - 2 LM 740	48W	4000K	9780	700	■	338
AS - 3 LM 740	72W	4000K	14670	700	■	374
AS - 3 LM 740	90W	4000K	17170	700	■	850
ST ME3M - 1 LM 740	24W	4000K	4890	700	■	286
ST ME3M - 2 LM 740	48W	4000K	9780	700	■	338
ST ME3M - 3 LM 740	72W	4000K	14670	700	■	374
ST ME3M - 3 LM 740	90W	4000K	17170	700	■	850
AS SPORT - 1 LM 740	24W	4000K	4890	700	■	286
AS SPORT - 2 LM 740	48W	4000K	9780	700	■	338
AS SPORT - 3 LM 740	72W	4000K	14670	700	■	374
AS SPORT - 3 LM 740	90W	4000K	17170	700	■	850



L90B20
>129.000h

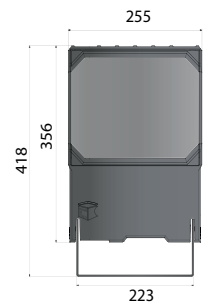
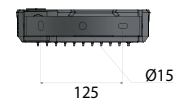

ACCESSOIRES



Paaladapter "T" ø 40/60 mm
Adapteur "T" ø 40/60 mm

€ 46



Paaladapter "Deco" ø 40/60 mm

OA / SD



Beschermingsrooster
Grille de protection

€ 33

De vermelde prijzen zijn indicatieve brutoprijzen zonder mogelijke opties of meerprijzen.
Deze zijn bedoeld om een vlotte budgettering te kunnen maken of te kunnen inschatten in welke prijsrichting het artikel zich bevindt.
Voor een nauwkeurige prijsofferte/ev. lichtstudie staat ons team ter uwer beschikking.

Les prix indiqués sont des prix bruts indicatifs sans les OPTIEs possibles ou suppléments de prix.
Le but étant de pouvoir faire une budgétisation rapide ou d'estimer dans quelle échelle de prix l'article se situe.
Notre équipe est à votre disposition pour une offre de prix précise ou une éventuelle étude d'éclairage.

INDUSTRIEEL | ATEX
INDUSTRIEL | ATEX



1 NANOTTICA

NEW

De **NANOTTICA** is een industrieel hermetisch waterdicht toestel die zich onderscheidt door het gebruik van een gepatenteerde diffusor met nanostructuur. Hierdoor is onder andere de efficiëntie en verblinding een heel stuk gunstiger. Daarnaast is het toestel optioneel verkrijgbaar met sensor en noodunit 1u/3u. De NANOTTICA haalt een nettorendement tot 162 Lm/W.

Le **NANOTTICA** est un appareil industriel hermétique étanche qui se distingue par l'utilisation d'un diffuseur breveté à nanostructure. Innovation qui améliore entre autres l'efficacité et le confort visuel. De plus, l'appareil est disponible en option avec un détecteur et une unité de secours 1h/3h. Les NANOTTICA atteignent une efficacité nette allant jusqu'à 162Lm/W.





NANOTTICA

ALGEMEEN / GÉNÉRALITÉS

TYPE waterproof

MATERIAAL polycarbonaat / polycarbonate | clips inox

REFLECTOR staalplaat / tôle d'acier

OPTION dimming: DALI

KENMERKEN / CARACTÉRISTIQUES

TYPE	W	CT	Lm	A (mm)	D (mm)	€ PRICE
NANOTTICA 1.2ft PCc 1300/840	8W	4000K	1240	615	110/370	64
NANOTTICA 1.2ft PCc 1600/840	10W	4000K	1490	615	110/370	64
NANOTTICA 1.2ft PCc 2200/840	14W	4000K	2070	615	110/370	64
NANOTTICA 1.4ft PCc 2600/840	16W	4000K	2430	1175	700/960	81
NANOTTICA 1.4ft PCc 3200/840	20W	4000K	2920	1175	700/960	81
NANOTTICA 1.4ft PCc 4400/840	27W	4000K	4090	1175	700/960	83
NANOTTICA 1.4ft PCc 6400/840	38W	4000K	5880	1175	700/960	86
NANOTTICA 1.5ft PCc 3250/840	20W	4000K	3050	1455	970/1230	92
NANOTTICA 1.5ft PCc 4000/840	24W	4000K	3650	1455	970/1230	92
NANOTTICA 1.5ft PCc 5500/840	33W	4000K	5090	1455	970/1230	94
NANOTTICA 1.5ft PCc 8000/840	45W	4000K	7280	1455	970/1230	99



L90B10
>50.000h

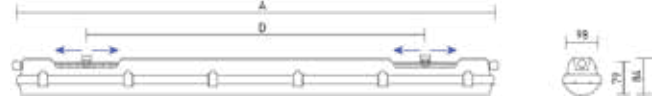



NANOTTICA TRS

ALGEMEEN / GÉNÉRALITÉS

Transparante behuizing voor een betere UGR / Corps transparent pour meilleure UGR



NANOTTICA ES

ALGEMEEN / GÉNÉRALITÉS

Energy Saver: hogere efficiëntie (Lm/W verhouding) wat resulteert in lager verbruik /
Meilleur rendement (Lm/W)



NANOTTICA NB

ALGEMEEN / GÉNÉRALITÉS

Narrow Beam: kleine stralingshoek voor hoge/smalle ruimtes van 7,5 tot 12 m / Faisceau
étroit pour les grandes hauteurs de 7,5 à 12 m



NANOTTICA WB

ALGEMEEN / GÉNÉRALITÉS

Wide Beam: brede stralingshoek voor lage ruimtes tussen 2,5 en 4 m / Faisceau large
pour les espaces réduits avec une hauteur de 2,5 à 4 m





NANOTTICA ABS

ALGEMEEN / GÉNÉRALITÉS

ABS behuizing voor hoge chemische resistentie / Corps ABS pour une grande résistance chimique



NANOTTICA MAX

ALGEMEEN / GÉNÉRALITÉS

Bestand tegen extreme temperaturen van - 40° C tot + 65° C / Résistant aux températures extrêmes de -40° à +65°C



NANOTTICA SNS

ALGEMEEN / GÉNÉRALITÉS

Versie met ingebouwde sensor geschikt voor installatiehoogte van 3,5 tot 6 m / Version avec détecteur intégré adapté pour une hauteur d'installation de 3,5 à 6 m





2 FUTURA

De **FUTURA** productlijn omvat industriële LED-armaturen die geschikt zijn voor gebruik in binnen- en buitenruimtes. Het LED-armatuur is bestand tegen stof, vocht en opspattend water, IP66. De behuizing en de diffuser zijn gemaakt van polycarbonaat (PC) en hebben een verhoogde weerstand tegen vervorming en impact.

Het FUTURA assortiment is nieuw uitgebreid met de variant bestemd voor hoge plafonds met smalle stralingskarakteristieken, geschikt voor de verlichting van rekgangen en smalle ruimtes met hoge plafonds.

La gamme de produits **FUTURA** comprend des luminaires industriels à LED adaptés à une utilisation en intérieur et en extérieur. Le luminaire à LED est résistant à la poussière, à l'humidité et aux éclaboussures d'eau, IP66. Le carter et le diffuseur sont en polycarbonate (PC) et ont une résistance accrue à la déformation et aux chocs.

La gamme FUTURA a été récemment étendue avec la variante conçue pour les hauts plafonds avec des caractéristiques de rayonnement étroites, adaptée à l'éclairage des couloirs d'étagères et des pièces étroites avec de hauts plafonds.



FUTURA





FUTURA

Doordat de **FUTURA** iets breder is dan de Nanottica herbergt deze een dubbel rij LED en koelribben. De Lumenoutput loopt hier dan ook op tot 16500 Lm op 104W!

Parce que le **FUTURA** est légèrement plus large que le Nanottica, il abrite une double rangée de LED et d'ailettes de refroidissement. Le lumenoutput monte ici aussi à 16500 Lm pour 104 W!

FUTURA

ALGEMEEN / GÉNÉRALITÉS

TYPE	waterproof
MATERIAAL	polycarbonate clips inox
OPTION	dimming: DALI - 3000K 5000K 6000K
COLOUR	■

1452KENMERKEN / CARACTÉRISTIQUES

TYPE	W	Lm	CT	A (mm)	d (mm)	€ PRICE
FUTURA 2.2ft PCc Al 2600/840	16W	2470	4000K	612	475	86
FUTURA 2.2ft PCc Al 3200/840	19W	2920	4000K	612	475	86
FUTURA 2.2ft PCc Al 4400/840	27W	4130	4000K	612	475	88
FUTURA 2.4ft PCc Al 5200/840	31W	4840	4000K	1172	700	111
FUTURA 2.4ft PCc Al 6400/840	37W	5880	4000K	1172	700	111
FUTURA 2.4ft PCc Al 8800/840	51W	8190	4000K	1172	700	117
FUTURA 2.4ft PCc Al 12800/840	84W	13160	4000K	1172	700	147
FUTURA 2.5ft PCc Al 6500/840	38W	6000	4000K	1452	940	127
FUTURA 2.5ft PCc Al 8000/840	46W	7290	4000K	1452	940	127
FUTURA 2.5ft PCc Al 11000/840	71W	11330	4000K	1452	940	132
FUTURA 2.5ft PCc Al 16000/840	104W	16500	4000K	1452	940	163



option

L90B10
>50.000h





FUTURA SNS

ALGEMEEN / GÉNÉRALITÉS

Uitgerust met bewegingssensor / Avec détecteur de mouvements



FUTURA ABS

ALGEMEEN / GÉNÉRALITÉS

ABS behuizing voor hoge chemische resistentie / Corps ABS pour une grande résistance chimique



FUTURA MAX

ALGEMEEN / GÉNÉRALITÉS

Bestand tegen extreme temperaturen van -40° tot +65° / Résistant aux températures extrêmes de -40° à +65°



FUTURA NB

ALGEMEEN / GÉNÉRALITÉS

Kleine stralingshoek / Faisceau étroit





3 INNOVA

De **INNOVA** is een industrieel hermetisch toestel met een kunststof basis en polycarbonaat cover. Het unieke aan dit toestel is de water- en stofdichtheid: de INNOVA is namelijk IP69. Hierdoor is hij bestand tegen iedere vorm van stof, vocht en opspattend water. Ook de overige technische specificaties zijn erg sterk: IK10, L90B10, ... Doordat de aansluitingen op de rug van het toestel zitten kunnen de toestellen tegen elkaar gemonteerd worden door middel van de meegeleverde snelconnectoren.

De INNOVA is voorzien van doorvoerbedrading in het toestel en snelconnectoren op de kopse zijden

L'**INNOVA** est un appareil hermétique industriel avec une base en plastique et un couvercle en polycarbonate. La particularité de cet appareil est sa résistance à l'eau et la poussière, l'INNOVA est IP69. Ce degré de protection le rend résistant à toutes formes de poussière, humidité et éclaboussures d'eau. Les autres spécifications techniques sont également très élevées: IK10, L90B10, ... Grâce aux connexions se trouvant au dos de l'appareil, ceux-ci peuvent être montés les uns aux autres au moyen de connecteurs rapides.

L'INNOVA est équipée d'un câblage traversant et de connecteurs rapides sur les cotés.

INNOVA





INNOVA

Gesloten en niet-demonteerbaar verlichtingsarmatuur geschikt voor binnen- en buitenruimte, industrie-, magazijn- en landbouwgebouwen, sportterreinen, werkplaatsen en laboratoria zonder explosiegevaar. Het structurele ontwerp van het armatuur (IP69) maakt een gelijkmatige plaatsing in de voedselverwerkende industrie mogelijk - HACCP.

Luminaire fermé et non démontable, adapté aux zones intérieures et extérieures, aux bâtiments industriels, d'entrepotage et agricoles, aux terrains de sport, aux ateliers et laboratoires sans risque d'explosion. La conception structurelle du luminaire (IP69) permet un positionnement uniforme dans l'industrie de la transformation alimentaire - HACCP.

INNOVA

ALGEMEEN / GÉNÉRALITÉS

TYPE waterproof

MATERIAAL polycarbonaat / polycarbonate

OPTION dimming: DALI - 3000K | 5000K | 6500K

COLOUR

KENMERKEN / CARACTÉRISTIQUES

TYPE	W	CT	Lm	A (mm)	d (mm)	€ PRICE
INNOVA 1.4ft PC 2600/840	16W	4000K	2430	1175	420 - 700	100
INNOVA 1.4ft PC 3200/840	20W	4000K	2920	1175	420 - 700	100
INNOVA 1.4ft PC 4400/840	27W	4000K	4090	1175	420 - 700	102
INNOVA 1.4ft PC 6400/840	38W	4000K	5880	1175	420 - 700	104
INNOVA 1.4ft PC 8800/840	51W	4000K	8790	1175	420 - 700	128
INNOVA 1.5ft PC 3250/840	20W	4000K	3050	1455	700 - 980	110
INNOVA 1.5ft PC 4000/840	24W	4000K	3650	1455	700 - 980	110
INNOVA 1.5ft PC 5500/840	33W	4000K	5090	1455	700 - 980	111
INNOVA 1.5ft PC 8000/840	45W	4000K	7280	1455	700 - 980	116
INNOVA 1.5ft PC 11000/840	71W	4000K	11330	1455	700 - 980	142



L90B10
>50.000h





INNOVA NB

ALGEMEEN / GÉNÉRALITÉS

Narrow beam of kleine stralingshoek / Narrow beam ou faisceau étroit



INNOVA WB

ALGEMEEN / GÉNÉRALITÉS

Wide beam of grote stralingshoek / Wide beam ou faisceau large



INNOVA ABS

ALGEMEEN / GÉNÉRALITÉS

LED-toestel met een diffusor uit opaal acrylaat en zwavelbestendige led-chips / Un appareil LED industriel avec un diffuseur en acrylique opale et des LED-chips résistants au soufre



INNOVA WB ABS

ALGEMEEN / GÉNÉRALITÉS

Combineert de eigenschappen van de Innova ABS en de Innova WB / Combine les propriétés de l'Innova ABS et de l'Innova WB.





4 AQUA 40 LED

NEW

De **AQUA 40 LED** is een buisvormig industrieel IP66 toestel vervaardigd uit polycarbonaat (mat of transparant). Het toestel wordt standaard door middel van beugels (kunststof of roestvrij staal) bevestigd op de muur of plafond.

De AQUA 40 is HACCP-gekeurd en kan optioneel voorzien worden van 1F-doorvoerbedrading.

Indien gewenst kan de AQUA 40 gependeld worden door middel van een accessoire.

L'**AQUA 40 LED** est un appareil industriel tubulaire IP66 en polycarbonate (mat ou transparent). L'appareil est monté en standard au mur ou au plafond au moyen de clips (en plastique ou en acier inoxydable).

L'AQUA 40 est LED certifié HACCP et peut être équipé en option d'un câblage traversant 1F.

Si besoin, l'AQUA 40 peut être suspendu à l'aide d'un accessoire.

AQUA 40





AQUA 40 LED

ALGEMEEN / GÉNÉRALITÉS

TYPE waterproof

MATERIAAL polycarbonaat / polycarbonate | mat / transparent

OPTION dimming: DALI

KENMERKEN / CARACTÉRISTIQUES

W	Lm	K	DIMENSIONS	€ PRICE
9W	1080	4000K	1032x52x56	226
17W	2160	4000K	1032x52x56	226
17W	2160	4000K	1558x52x56	234
35W	4320	4000K	1558x52x56	234
26W	3240	4000K	2065x52x56	278
52W	6481	4000K	2065x52x56	278



option option

L80B10
>70.000h

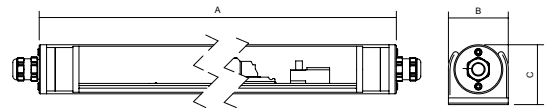



5 AQUA 70 LED

NEW

De **AQUA 70 LED** is een buisvormig industrieel IP69 toestel vervaardigd uit polycarbonaat (PC-versie) of polymethylmethacrylaat (PMMA-versie).

Het toestel wordt standaard door middel van beugels (kunststof of roestvrij staal) bevestigd op de muur of plafond.

De AQUA 70 kan voorzien worden van optionele noodunit (1u/3u), doorvoerbekabeling (1F/3F) en kan indien gewenst ook gependeld worden door middel van een accessoire.

L'**AQUA 70 LED** est un appareil industriel tubulaire IP69 en polycarbonate (version PC) ou en polyméthacrylate de méthyle (version PMMA).

L'appareil est installé en standard au mur ou au plafond au moyen de clips (en plastique ou en acier inoxydable).

L'AQUA 70 peut être équipé en option d'une unité de secours (1h/3h), d'un câblage traversant (1F/3F) et peut également être suspendu à l'aide d'un accessoire si nécessaire.

AQUA 70





AQUA70 LED

ALGEMEEN / GÉNÉRALITÉS

TYPE waterproof

MATERIAAL polycarbonaat of polymethylmethacrylaat / polycarbonate ou polyméthacrylate de méthyle

OPTION dimming: DALI

KENMERKEN / CARACTÉRISTIQUES

W	Lm	K	DIMENSIONS	€ PRICE
17W	1903	4000K	780x70x70	265
35W	3806	4000K	1270x70x70	352
52W	5709	4000K	1740x70x70	435



option option

L80B10
>70.000h

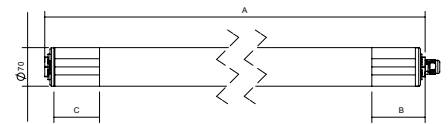



6 BOXER

NEW

De **BOXER** is een vandaalbestendig opbouwtoestel ontworpen voor gevangenissen, ziekenhuizen en openbare plaatsen als tunnels, treinstations, etc.

Optioneel kan het toestel worden uitgerust met een sensor, noodunit, doorvoerbekabeling en waaklicht (4-8W).

Le **BOXER** est un appareil apparent anti-vandalisme destiné aux prisons, hôpitaux et lieux publics tels que tunnels, gares, etc.

En option, l'appareil peut être équipé d'un détecteur, d'une unité de secours, d'un câblage traversant ou d'une veilleuse (4-8W).

BOXER





BOXER

ALGEMEEN / GÉNÉRALITÉS

TYPE anti-vandaal opbouw / anti-vandale apparent

MATERIAAL staalplaat / tôle d'acier

REFLECTOR aluminium

OPTION dimming: DALI

KENMERKEN / CARACTÉRISTIQUES

W	Lm	K	DIMENSIONS	€ PRICE
8W	1123	4000K	421x184x56	294
11W	1413	4000K	421x184x56	298
18W	2393	4000K	701x184x56	344
22W	2826	4000K	701x184x56	379
36W	4786	4000K	1257x184x56	489
41W	5368	4000K	1257x184x56	497
48W	6350	4000K	1519x184x56	539
51W	6710	4000K	1519x184x56	518



L80B10
>70.000h

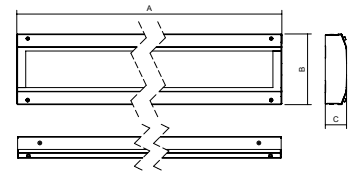

ACCESSOIRES

Set voor hoekmontage / Kit par installation d'angle



7 STAFORD

NEW

De **STAFORD** is een vandaalbestendig inbouwtoestel ontworpen voor gevangenissen, ziekenhuizen en openbare plaatsen als tunnels, treinstations, etc.

Optioneel kan het toestel worden uitgerust met een sensor, noodunit, doorvoerbekabeling en waaklicht (4-8W).

Le **STAFORD** est un appareil encastré anti-vandalisme destiné aux prisons, hôpitaux et lieux publics tels que tunnels, gares, etc.

En option, l'appareil peut être équipé d'un détecteur, d'une unité de secours, d'un câblage traversant ou d'une veilleuse (4-8W).

STAFORD





STAFORD

ALGEMEEN / GÉNÉRALITÉS

TYPE anti-vandaal inbouw / anti-vandale encastré

MATERIAAL staalplaat / tôle d'acier

DIFFUSER polycarbonaat opaal / opale polycarbonate

OPTION dimming: DALI

KENMERKEN / CARACTÉRISTIQUES

W	Lm	K	DIMENSIONS	€ PRICE
21W	2562	4000K	653x255x95	514
29W	3368	4000K	653x255x95	514
34W	3890	4000K	653x255x95	514
43W	5052	4000K	953x255x95	601
51W	5838	4000K	953x255x95	621
58W	6736	4000K	1253x255x95	632
68W	7781	4000K	1253x255x95	971



option option option

L80B10
>70.000h

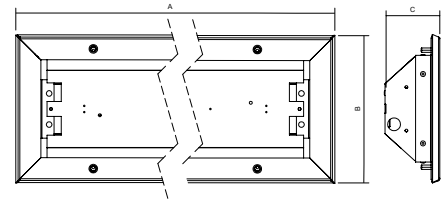

ACCESSOIRES

Set voor montage in beton / Kit par installation dans béton



8 FROST PLUS

NEW

De **FROST PLUS** is een hermetisch IP66 toestel specifiek ontworpen voor vriescellen en koelkamers.

Het toestel is bestand tegen extreem koude temperaturen tot -40°C .

Le **FROST PLUS** est un appareil hermétique IP66 spécialement conçu pour les congélateurs et chambres froides.

L'appareil peut résister à des températures négatives extrêmes jusqu'à -40°C .

FROST PLUS





FROST PLUS

ALGEMEEN / GÉNÉRALITÉS

TYPE waterproof

MATERIAAL ABS | plastic clips / clips plastique

DIFFUSER acrylaat / acrylate

KENMERKEN / CARACTÉRISTIQUES

W	Lm	CT	Min (°C)	A (mm)	D (mm)	COLOR	€ PRICE
31	4530	4000K	-40	1172	700	■	148
37	5510	4000K	-40	1172	700	■	148
51	7660	4000K	-40	1172	700	■	152
38	5610	4000K	-40	1452	940	■	165
46	6820	4000K	-40	1452	940	■	165
71	10600	4000K	-40	1452	940	■	169



L90B10
>50.000h





9 TRUNKING

NEW

De **TRUNKING LED** is een modern lineair systeem dat hoogwaardige functies combineert met een eenvoudige installatie. De armatuur bestaat uit een stevige aluminium voet die verkrijgbaar is in de maten 225 cm of 450 cm en verlichtingsmodules met verschillende vermogens die zijn afgestemd op de behoeften van elk gebouw. De Trunking LED biedt een reeks accessoires, waaronder bewegingssensoren, noodverlichtingsmodules en speciale afdichtingen die de waterdichtheid verhogen tot IP44. Dit systeem vervangt ook kabelgoten, waardoor het kosteneffectief is. Technisch gezien heeft het een indrukwekkende lichtefficiëntie tot 176 Lm/W.

Le **TRUNKING LED** est un système linéaire moderne qui combine des fonctions de haute qualité avec une installation facile. Le luminaire se compose d'une base robuste en aluminium disponible en 225 cm ou 450 cm et de modules d'éclairage de différentes puissances adaptés aux besoins de chaque bâtiment. Le Trunking LED offre une gamme d'accessoires, notamment des détecteurs de mouvement, des modules d'éclairage de secours et des joints spéciaux qui augmentent l'étanchéité à l'eau jusqu'à IP44. Ce système remplace également les chemins de câbles, ce qui le rend rentable. D'un point de vue technique, il présente une efficacité lumineuse impressionnante allant jusqu'à 176 Lm/W.



TRUNKING

ALGEMEEN / GÉNÉRALITÉS

TYPE opbouw, pendel / apparent, suspendu

MATERIAAL aluminium

DIFFUSER transparant acrylaat / acrylate translucide

CT 3000K | 4000K | 5000K

OPTION dimming: DALI

KENMERKEN / CARACTÉRISTIQUES

W	Lm	CT		HxWxL (mm)	€ PRICE
74	13000	4000	30° 50° 80°	40x60x2250	OA / SD
94	16000	4000	30° 50° 80°	40x60x2250	OA / SD
116	19000	4000	30° 50° 80°	40x60x2250	OA / SD



option

option

option

option

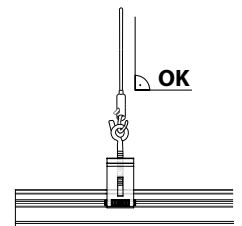
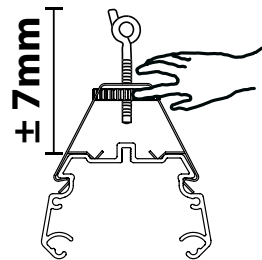
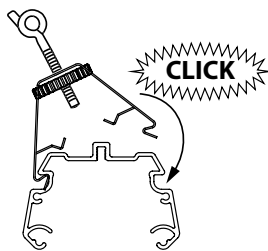
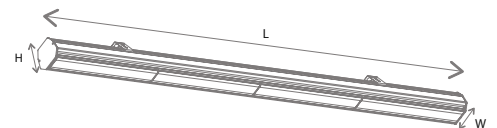

**MONTAGE
TRUNKING**



10 PRIMA LED EX

De **PRIMA LED EX** is een industrieel LED armatuur geschikt voor omgevingen met gevaar voor explosies (groep II, categorie 3 (ZONE 2, 22)), gas, stof en brandbare dampen.

Le **PRIMA LED EX** est un éclairage industriel LED conçu pour les environnements avec danger d'explosion (groupe II, catégorie 3 (ZONE 2, 22)), gaz, poussière et vapeurs inflammables.



II 3G Ex nR ICC T6 Gc
II 3D Ex tc IIIC T170°C Dc



PRIMA LED EX





PRIMA LED EX

ALGEMEEN / GÉNÉRALITÉS

TYPE	Atex voor / pour zone 2-22
MATERIAAL	polycarbonate clips inox
OPTION	dimming: DALI - 3000K 5000K 6500K

KENMERKEN / CARACTÉRISTIQUES

TYPE	W	CT	Lm	COLOR	A (mm)	d (mm)	€ PRICE
PRIMA LED EX 1.2ft PCc 1600/840	11W	4000K	1690	■	662	350	96
PRIMA LED EX 1.2ft PCc 2200/840	16W	4000K	2350	■	662	350	97
PRIMA LED EX 1.4ft PCc 3200/840	23W	4000K	3300	■	1272	700	136
PRIMA LED EX 1.4ft PCc 4400/840	31W	4000K	4660	■	1272	700	136
PRIMA LED EX 1.4ft PCc 6400/840	44W	4000K	6710	■	1272	700	146
PRIMA LED EX 1.5ft PCc 4000/840	27W	4000K	4150	■	1572	940	153
PRIMA LED EX 1.5ft PCc 5500/840	38W	4000K	5810	■	1572	940	155
PRIMA LED EX 1.5ft PCc 8000/840	53W	4000K	8300	■	1572	940	163
PRIMA LED EX 2.2ft PCc 3200/840	22W	4000K	3330	■	662	350	110
PRIMA LED EX 2.2ft PCc 4400/840	31W	4000K	4710	■	662	350	112
PRIMA LED EX 2.4ft PCc 6400/840	43W	4000K	6710	■	1272	700	153
PRIMA LED EX 2.4ft PCc 8800/840	60W	4000K	9340	■	1272	700	195
PRIMA LED EX 2.4ft PCc 12800/840	85W	4000K	13330	■	1272	700	189
PRIMA LED EX 2.5ft PCc 8000/840	54W	4000K	8310	■	1572	940	176
PRIMA LED EX 2.5ft PCc 11000/840	71W	4000K	11080	■	1572	940	177
PRIMA LED EX 2.5ft PCc 16000/840	106W	4000K	16520	■	1572	940	212
PRIMA LED EX 2.5ft PCc 20000/840	118W	4000K	17660	■	1572	940	212



L90B10
>50.000h

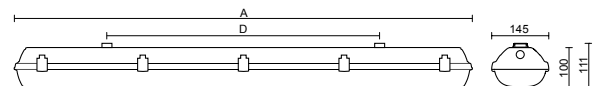



11 TrEx

De **TREX** is een explosieveilig zone 2, 22 cat 2 en zone 1,21 toestel vervaardigd uit metaal en gehard veiligheidsglas.

Optioneel is 1F /3F doorvoerbekabeling en een noodunit 1u / 3u beschikbaar.

NEW

Le **TREX** est un appareil antidéflagrant zone 1,21 et 2,22, cat. 2 en métal avec verre de sécurité trempé.

Un câblage traversant 1F/3F et/ou une unité de secours 1h/3h sont disponibles en option.



II 2D Ex tb IIIC T 68°C IP66 Db

TREX





TrEx

ALGEMEEN / GÉNÉRALITÉS

TYPE Atex voor / pour zone 1-21 & 2-22

MATERIAAL staalplaat / tôle d'acier

DIFFUSER gesatineerd gehard veiligheidsglas / verre de sécurité trempé satiné

KENMERKEN / CARACTÉRISTIQUES

W	Lm	CT	Max (°C)	A (mm)	D (mm)	€ PRICE
19	2350	4000K	55	730	350	805
27	3360	4000K	55	730	350	805
35	4700	4000K	55	1300	700	1016
50	6720	4000K	55	1300	700	1016
35	4700	4000K	55	730	350	1062
50	6720	4000K	50	730	350	1062
67	9400	4000K	55	1300	700	1489
100	13440	4000K	50	1300	700	1489



L80B50
>75.000h





12 AQUA 70 EX

NEW

De **AQUA 70 EX** is een buisvormig zone 1,21 cat. 2 ATEX toestel. Het toestel wordt standaard door middel van beugels (kunststof of roestvrij staal) bevestigd op de muur of plafond.

De AQUA 70 EX kan voorzien worden van optionele doorvoerbekabeling 1F of 3F en kan indien gewenst ook gependeld worden door middel van een accessoire.

L'**AQUA 70 EX** est un appareil tubulaire ATEX pour zone 1,21 cat. 2. L'appareil est installé en standard au mur ou au plafond au moyen de clips (en plastique ou en acier inoxydable).

L'AQUA 70 EX peut être équipé d'un câblage traversant (1F ou 3F) et peut également être suspendu à l'aide d'un accessoire si nécessaire.



II 2G Ex db eb mb op is IIc T4 Gb
II 2D Ex tb op is IIIC T62°C Db

AQUA 70 EX





AQUA 70 EX

ALGEMEEN / GÉNÉRALITÉS

TYPE Atex voor / pour zone 1-21

MATERIAAL polycarbonaat / polycarbonate

OPTIE dimming: DALI

KENMERKEN / CARACTÉRISTIQUES

W	Lm	K	DIMENSIONS	€ PRICE
16W	2107	4000K	1149x425x65	962
28W	3061	4000K	1149x425x65	965
30W	4175	4000K	1709x425x65	1167
51W	5985	4000K	1709x425x65	1239



L80B50
>45.000h

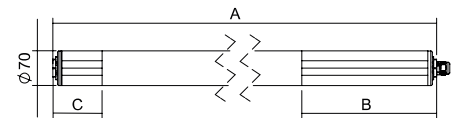



13 PITBUL-N-LED

NEW

De **PITBUL N LED** is een zone 2, 22 cat. 3 ATEX toestel met outputs tot 24.845Lm netto en is bestand tegen agressieve of chemische stoffen zoals vetten.

Het toestel is specifiek ontworpen voor zware industriële- en productieomgevingen.

Le **PITBUL N LED** est un appareil ATEX zone 2, 22 cat. 3 avec une luminosité allant jusqu'à 24.845Lm net et résistant aux substances agressives ou chimiques (graisses par exemple).

L'appareil est spécialement conçu pour l'industrie lourde et d'autres domaines de production.



II 3D Ex tc IIIC T 63°C Dc

PITBUL-N-LED





PITBUL-N-LED

ALGEMEEN / GÉNÉRALITÉS

TYPE Atex voor / pour zone 2-22

MATERIAAL staalplaat / tôle d'acier

DIFFUSER opaal gehard veiligheidsglas / Verre de sécurité trempé opale

OPTION dimming: DALI | nood / secours

KENMERKEN / CARACTÉRISTIQUES

W	Lm	K	DIMENSIONS	€ PRICE
35W	4470	4000K	703x310x142	875
70W	8940	4000K	1313x310x142	1083
104W	13410	4000K	1613x310x142	1178
70W	8899	4000K	703x369x142	984
121W	15895	4000K	1313x369x142	1256
195W	24845	4000K	1613x369x142	1438



L80B10
>70.000h

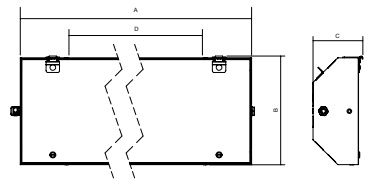



14 BASET-N-LED

NEW

De **BASET-N-LED** is een explosieveilig Zone 2/22 cat.3 toestel met compacte afmetingen.
Het toestel kan voorzien worden van een geïntegreerde noodunit of uitsluitend als noodtoestel geschakeld worden.

Le **BASET-N-LED** est un appareil antidéflagrant Zone 2/22 cat.3 aux dimensions compactes.
L'appareil peut être équipé d'une unité de secours ou peut être utilisé comme bloc de secours uniquement.



II 3D Ex tc IIIC T65°C Dc

BASET-N-LED





BASET-N-LED

ALGEMEEN / GÉNÉRALITÉS

TYPE Atex voor / pour zone 2-22

MATERIAAL polycarbonaat / polycarbonate

DIFFUSER polycarbonaat opaal / opale polycarbonate

OPTION dimming: DALI | nood / secours

KENMERKEN / CARACTÉRISTIQUES

W	Lm	K	DIMENSIONS	€ PRICE
9W	1160	4000K	338x176x110	164
10W	1312	4000K	338x176x110	164
13W	1604	4000K	338x176x110	164
15W	1941	4000K	338x176x110	185
18W	2243	4000K	338x176x110	185
20W	2537	4000K	338x176x110	185



L80B10
>60.000h

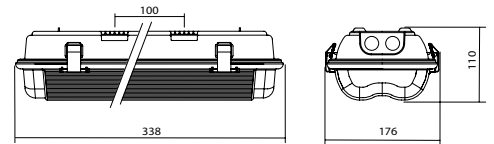



15 SECURE LED

De **SECURE LED** is een buisvormig Zone 2-22 Atex toestel. Het toestel is gebouwd met een opaal polycarbonaat behuizing en een heldere aluminium reflector, ABS-afdekkingen en verzinkte stalen flenzen. ATEX-kabelwartels zijn ook verkrijgbaar. Het is perfect voor gebruik in zones met explosiegevaar.

Le **SECURE LED** est un appareil tubulaire Atex Zone 2-22. L'armature est construite avec un boîtier en polycarbonate opale et un réflecteur en aluminium transparent, des couvercles en ABS et des brides en acier galvanisé. Des presse-étoupes ATEX sont également disponibles. Il est parfait pour une utilisation dans des zones dangereuses.



Ex II 3GD
Ex nR IIC T6 Gc
Ex tc IIIC T85 °C Dc

SECURE LED





SECURE LED

ALGEMEEN / GÉNÉRALITÉS

TYPE Atex voor / pour zone 2-22

MATERIAAL opaal polycarbonaat anti-UV van 3,5 mm dik / polycarbonate anti-UV de 3,5 mm d'épaisseur - OPAL

REFLECTOR glanzend aluminium / aluminium brillant

OPTION dimming: DALI | 4000K | nood / secours

KENMERKEN / CARACTÉRISTIQUES

W	Lm	CT	L (mm)	D (mm)	€ PRICE
13W	997	3000K	727	83	257
16W	1712	3000K	727	83	303
24W	1993	3000K	1337	83	431
32W	3424	3000K	1337	83	464
29W	2488	3000K	1637	83	473
40W	4220	3000K	1637	83	588



L70B50
>50.000h



ACCESSOIRES

anti-vandaal clipsen in gegalvaniseerd staal / colliers antivandalisme en acier galvanisé



Atex Wartel inbegrepen / Presse-étoupe ATEX inclus



16 HYPER PRO

NEW

Waar de Cannon het standaardtype binnen het gamma is biedt de **HYPER PRO** meerdere technische mogelijkheden. Zo kan het toestel worden uitgerust met 1-10V, Dali 2, noodunit 1u/3u, 3000K/5000K, CRI 90, RAL-kleur naar keuze, ...

Si le Cannon est le standard de notre gamme, l'**HYPER PRO** propose quant à lui plusieurs options techniques. L'appareil peut ainsi être équipé de 1-10V, Dali 2, module de secours 1h/3h, 3000K/5000K, CRI 90, couleur RAL au choix, ...

HYPER PRO





HYPHER PRO

ALGEMEEN / GÉNÉRALITÉS

TYPE	klok / cloche
MATERIAL	die-cast aluminium
DIFFUSER	opal PMMA / PMMA opale Anti UV
OPTION	dimming: DALI 1-10V

W	CT	Lm	mA	COLOR	€ PRICE
87.5W	4000K	15360	385	■	301
136W	4000K	22375	570	■	301
177W	4000K	30820	770	■	342
210W	4000K	33770	850	■	411
87.5W	4000K	15360	385	■	301
136W	4000K	22375	570	■	301
177W	4000K	30820	770	■	342
210W	4000K	33770	850	■	411



L80B20
>108.000h

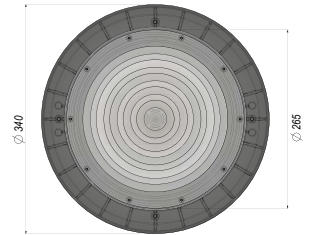
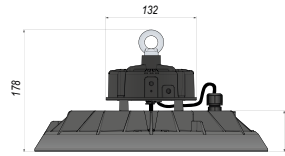

ACCESSOIRES



Beschermingsrooster
Gille de protection

€ 44

4 mm gehard beschermingsglas / Verre trempé

€ 25

Plafond/muur draaibare beugel / Support orientable

€ 22



17 CANNON II

De **CANNON II** is het standaard kloktoestel binnen ons gamma met gunstige prijs/kwaliteitsverhouding.
De hoge efficiëntie (160Lm/W) en ENEC keuring maken van dit toestel een zeer interessante oplossing voor industriële toepassingen.

Le **CANNON II** est la cloche standard de notre gamme avec un rapport qualité/prix avantageux.

Le rendement élevé (160Lm/W) et la certification ENEC font de cet appareil une solution très intéressante pour les applications industrielles.

NEW

CANNON II





CANNON II

ALGEMEEN / GÉNÉRALITÉS

TYPE klok / cloche

MATERIAL aluminium

OPTION dimming: 1-10V

W	CT	Lm	Temperature	COLOR	€ PRICE
150W	4000K	24158Lm	-30° / 50°C	■	180
200W	4000K	32550Lm	-30° / 50°C	■	210



option

L90B20
>50.000h

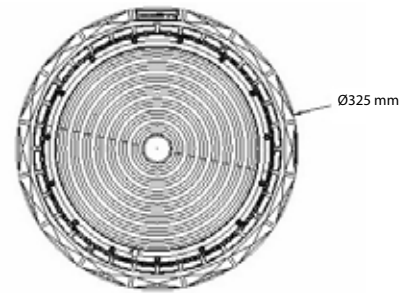
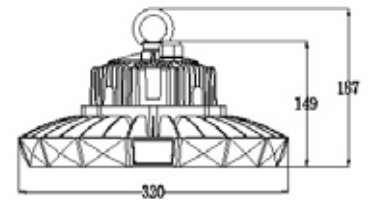

De vermelde prijzen zijn indicatieve brutoprijzen zonder mogelijke opties of meerprijzen.
Deze zijn bedoeld om een vlugge budgettering te kunnen maken of te kunnen inschatten in welke prijsrichting het artikel zich bevindt.
Voor een nauwkeurige prijsofferte/ev. lichtstudie staat ons team ter uwer beschikking.

Les prix indiqués sont des prix bruts indicatifs sans les options possibles ou suppléments de prix.
Le but étant de pouvoir faire une budgétisation rapide ou d'estimer dans quelle échelle de prix l'article se situe.
Notre équipe est à votre disposition pour une offre de prix précise ou une éventuelle étude d'éclairage.

NOODVERLICHTING
ECLAIRAGE DE SECOURS



1 ONTEC C - D

Door de kleine afmetingen van de **ONTEC C - D** is dit noodtoestel geschikt voor elk interieur zonder dat deze opvalt tussen de algemene verlichting. De Ontec bestaat ook als COLD versie, welke ontworpen is om bij lage vriestemperaturen te functioneren. De behuizing is ontworpen om een eenvoudige installatie te verzekeren bij verschillende installatiemogelijkheden. Gegarandeerde naleving van de nieuwste noodverlichtingsnormen.

Grâce à ses petites dimensions, l'**ONTEC C - D** convient à tous les intérieurs, sans se faire remarquer parmi l'éclairage général. Également disponible en version COLD, adapté à un fonctionnement à basse température. Le boîtier de l'ONTEC C-D est conçu de manière à pouvoir être utilisé pour diverses options d'installation. Le respect des dernières normes en matière d'éclairage de secours est garanti.



ONTEC C



ONTEC D





ONTEC C

ONTEC C-D

ALGEMEEN / GÉNÉRALITÉS

TYPE	inbouw / encastré
MATERIAL	PC
COLOUR	□ ■ + speciale kleuren / couleurs spéciales
OPTION	DALI permanente versie / version permanent
AUTONOMIE	1 u./h. 3 u. verkrijgbaar / 3 h. disponible
TEST	autotest

ONTEC C

KENMERKEN / CARACTÉRISTIQUES

TYPE	APPLICATION*	W	Lm	MODE	€ PRICE
Ontec C M1	Anti-paniek	3W	338	NM	136
Ontec C C1	Vluchtweg	3W	297	NM	142



option



ONTEC D

ONTEC D

KENMERKEN / CARACTÉRISTIQUES

TYPE	APPLICATION*	W	Lm	MODE	€ PRICE
Ontec D M1	Anti-paniek	3W	338	NM	136
Ontec D C1	Vluchtweg	3W	297	NM	142



option

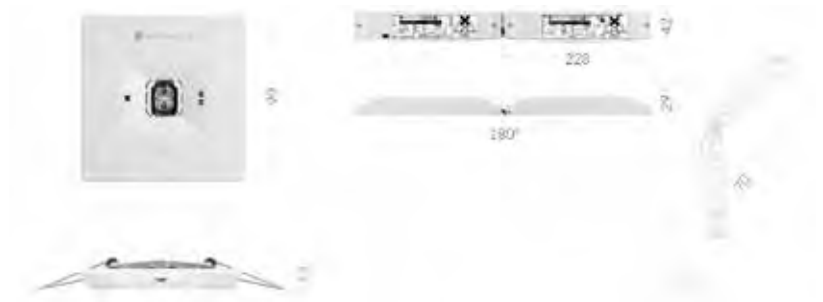

* Anti-paniek / Antipanique
Vluchtweg / Chemin d'évacuation



2 ONTEC S

Dankzij zijn eenvoudig design en IP65-bescherming kan de **ONTEC S** serie voor bijna elke toepassing gebruikt worden. Van moderne, open gebouwen tot grote, vochtige parkeergarages. Omdat het toestel uitgerust is met de hoogste kwaliteit LED-diodes, is de lichtopbrengst maximaal. Afhankelijk van welke optiek er gebruikt wordt, kan dit toestel perfect gebruikt worden in open of smalle ruimtes. Zijn eenvoudig design laat het toe om er doormiddel van een diffuser een dubbelzijdig noodtoestel van te maken.

Grâce à sa conception simple et son degré de protection IP65, la série **ONTEC S** peut presque être utilisée pour toutes les applications. Des bâtiments modernes, ouverts, aux grands parkings humides. Le luminaire est équipé de diodes LED de la plus grande qualité, ce qui fait que la sortie de lumière est maximale. En fonction de l'optique utilisée, ce luminaire peut parfaitement convenir pour de grands ou petits espaces. Son design simple permet un éclairage de secours double face à l'aide d'un diffuseur.



ONTEC S

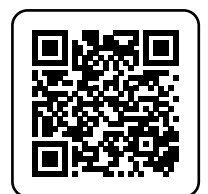



ONTEC S

ALGEMEEN / GÉNÉRALITÉS

TYPE	opbouw / apparent
MATERIAL	PC
COVER	PC transparant / PC transparent
COLOUR	□ ■ + speciale kleuren / couleurs spéciales
OPTION	dimming: DALI montage > 7 m
AUTONOMIE	1 u./h. 3 u. verkrijgbaar / 3 h. disponible
TEST	autotest

KENMERKEN / CARACTÉRISTIQUES

TYPE	APPLICATION*	W	Lm	MODE	€ PRICE
Ontec S M1	Anti-paniek	3W	360	M/NM	86
Ontec S M5	Anti-paniek	5W	576	M/NM	171
Ontec S C1	Vluchtweg	3W	282	M/NM	138
Ontec S C2	Vluchtweg	5W	453	M/NM	181
Ontec S W1	Finale uitgang	3W	289	M/NM	128
Ontec S W2	Finale uitgang	5W	388	M/NM	181

COLD VERSION: -15° C tot / à +40°C - voor buitentoepassingen / pour applications à l'extérieur

Ontec S M2 Cold	Anti-paniek	5W	241	NM	162
Ontec S M5 Cold	Anti-paniek	5W	376	NM	215
Ontec S C1 Cold	Vluchtweg	5W	225	NM	166
Ontec S W1 Cold	Finale uitgang	5W	204	NM	166



L90B10
>50.000h



ACCESSOIRES

Inbouw montagebeugel / Kit d'encastrement	€ 11
Wandkap / Protection murale	€ 25
Beschermingsrooster / Grille de protection	€ 44
Diffusor vlag / Diffuseur drapeau	€ 26
IP 67 cover / Cadre IP67	€ 59

Voor meer info raadpleeg onze website of via de QR-code.

Pour plus d'informations consultez notre site web ou scannez le QR code.

* Anti-paniek / Antipanique
Vluchtweg / Chemin d'évacuation
Finale uitgang / Sortie finale



3 ONTEC S30

De **ONTEC S30** is een IP65-noodtoestel met een uitzonderlijk hoge lichtopbrengst voor het type toestel.

Ondanks zijn relatief beperkte afmetingen is het toestel met 1321Lm geschikt om geplaatst te worden op hoge hoogtes en met grotere tussenafstanden.

NEW

L'**ONTEC S30** est un luminaire de secours IP65 avec un rendement lumineux exceptionnellement élevé pour ce type d'appareil.

Malgré ses dimensions relativement compactes, l'appareil de 1321Lm est adapté à un placement à des grandes hauteurs et avec de grandes interdistances.

ONTEC S30





ONTEC S30

ALGEMEEN / GÉNÉRALITÉS

TYPE	opbouw / apparent
MATERIAL	PC
COVER	PC transparant / PC transparent
COLOUR	□
OPTION	DALI permanente versie / version permanent montage > 7 m
AUTONOMIE	1 u./h. 3 u. verkrijgbaar / 3 h. disponible
TEST	autest

KENMERKEN / CARACTÉRISTIQUES

TYPE	APPLICATION*	Lm	MODE	€ PRICE
ONTEC S30 M5	Anti-paniek	1321	NM	185
ONTEC S30 C5	Vluchtweg	1247	NM	192



option

L90B10
>50.000h



ACCESSOIRES

Inbouw montagebeugel / Kit d'encastrement	€ 11
Beschermingsrooster / Grille de protection	€ 54
Diffusor vlag / Diffuseur drapeau	€ 39
IP 67 cover / Cadre IP67	€ 89

* Anti-paniek / Antipanique
Vluchtweg / Chemin d'évacuation



4 ONTEC G

Éen toestel, veel mogelijkheden! Dit opbouwtoestel kan met een eenvoudig accessoire als inbouwtoestel geplaatst worden, hierdoor kan de **ONTEC G** bijna toegepast worden in elke situatie. De hoge helderheid tot 300 cd/m² en tweezijdige signalering zorgen voor een optimale zichtbaarheid.

Un seul appareil pour de nombreuses possibilités! Cet appareil apparent peut être encastré à l'aide d'un simple accessoire, ce qui permet d'utiliser l'**ONTEC G** dans presque tous les cas de figure. La haute luminosité jusqu'à 300 cd/m² et la signalisation double face garantissent une visibilité optimale.



ONTEC G





ONTEC G

ALGEMEEN / GÉNÉRALITÉS

TYPE opbouw / apparent

APPLICATION signalisatie / signalisation

MATERIAL PC

COVER PC transparant / transparent

COLOUR + speciale kleuren / couleurs spéciales

OPTION dimming: DALI

TEST autotest

KENMERKEN / CARACTÉRISTIQUES

TYPE	LUMINANCE	MODE	AUTONOMIE	€ PRICE
Ontec G E1E	>300cd/m ²	M	3h	148



ACCESSOIRES



Pendelset / Suspension

€ 56



Inbouwset / Kit d'encastrement

€ 22



Voor meer info en uitleg, raadpleeg onze website of via de QR-code.

Pour plus d'informations et d'explications, consultez notre site internet ou scannez le QR code.



5 ONTEC E

De **ONTEC E** is een signalisatietoestel voor muurbevestiging. De ONTEC E kan zowel als inbouw- en opbouwtoestel gemonteerd worden. Daarnaast heeft de EIP-versie met LiFePO4 batterij een helderheid van $>300 \text{ cd/m}^2$.

L'**ONTEC E** est un appareil de signalisation pour montage mural. L'ONTEC E peut être monté comme appareil encastré ou apparent. De plus, la version EIP avec une batterie LiFePO4 a une luminosité supérieure à $>300 \text{ cd/m}^2$.



ONTEC E





ONTEC E

ALGEMEEN / GÉNÉRALITÉS

TYPE opbouw wand / apparent sur mur

APPLICATION signalisatie / signalisation

MATERIAL PC

COVER PC transparant / transparent

COLOUR + speciale kleuren / couleurs spéciales

OPTION dimming: DALI

TEST autotest

KENMERKEN / CARACTÉRISTIQUES

TYPE	LUMINANCE	MODE	AUTONOMIE	€ PRICE
Ontec E E1P	>300cd/m ²	M / NM	3h	162



option





6 ONTEC R

De **ONTEC R** is een eenvoudig en uniform noodtoestel voor plafondbevestiging. De ONTEC R kan zowel als inbouw- en opbouwtoestel gemonteerd worden.

Er zijn verschillende versies beschikbaar om in bijna elke situatie toe te passen: open ruimtes, grote hoge ruimtes, gangen, hoge gangen, uitgangen, verlichting van brandblusapparaten,...

L'**ONTEC R** est un appareil de secours simple et uniforme pour un montage au plafond. L'ONTEC R peut être monté comme appareil encastré ou apparent. Afin de pouvoir répondre à presque toutes les situations, différentes versions sont disponibles: espaces ouverts, grandes pièces hautes, couloirs, couloirs hauts, sorties, éclairage d'extincteurs,...

ONTEC R

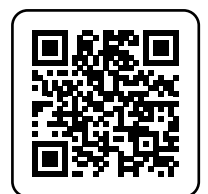



ONTEC R

ALGEMEEN / GÉNÉRALITÉS

TYPE	opbouw / apparent
MATERIAL	PC
COLOUR	□ ■ + speciale kleuren / couleurs spéciales
OPTION	dimming: DALI
AUTONOMIE	1 u./h. 3 u. verkrijgbaar / 3 h. disponible
TEST	autotest

KENMERKEN / CARACTÉRISTIQUES

TYPE	APPLICATION*	W	Lm	MODE	€ PRICE
Ontec R M1	Anti-paniek	2W	360	NM	126
Ontec R M5	Anti-paniek	5W	615	NM	162
Ontec R C1	Vluchtweg	2W	306	NM	132
Ontec R C2	Vluchtweg	5W	541	NM	173
Ontec R W1	Finale uitgang	2W	325	NM	132



option

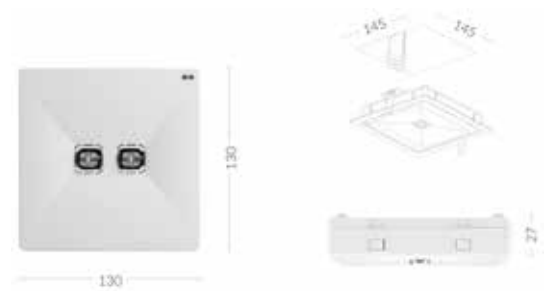

ACCESSOIRES



Inbouw montagebeugel / Kit d'encastrement

€ 22



* Anti-paniek / Antipanique
Vluchtweg / Chemin d'évacuation
Finale uitgang / Sortie finale



7 DATA 2

Het **DATA 2** systeem controleert de werking van noodverlichtingstoestellen die geïnstalleerd zijn in grote gebouwen. Door functie- en autonomietesten uit te voeren kan de werking gecontroleerd worden. Deze testen kunnen ingesteld worden door de gebruiker. Dit is gemakkelijk in te stellen door het drukscherm en gebruiksvriendelijke interface.

Le système **DATA 2** contrôle le fonctionnement des blocs de secours installés dans les grands bâtiments. En effectuant des tests d'opérations et d'autonomie, le fonctionnement peut être vérifié. Ces tests peuvent être définis par l'utilisateur et peuvent se configurer simplement à l'aide de l'écran tactile et de l'interface facile à utiliser.

DATA 2

ALGEMEEN / GÉNÉRALITÉS

TYPE	bedienen van noodverlichtingsarmaturen / contrôle des luminaires de secours
MATERIAL	gepoederlakt staal / tôle thermolaquée
DIMENSIONS	485 H x 302 W x 70 D mm
PROTECTION	IP20
ISOLATION	I

KENMERKEN / CARACTÉRISTIQUES

- instellingen via drukscherm en gebruiksvriendelijke interface / configuration via l'écran tactile et l'interface simple
- verslagen opmaken en opslaan in het systeem / création et enregistrement des rapports dans le système
- volledig overzicht van systeem / aperçu complet du système
- beveiliging met paswoord, met verschillende machtigingen / sécurité avec mot de passe, avec différentes autorisations
- mogelijkheid om tot 4096 toestellen toe te voegen / possibilité d'ajouter jusqu'à 4096 périphériques
- mogelijkheid om toestellen afzonderlijk te testen / possibilité de tester les appareils séparément
- automatische en cyclische tests volgens ingestelde schema's / tests automatiques et cycliques selon des schémas définis
- online de status controleren van het DATA 2 systeem / contrôle en ligne de l'état du système DATA 2
- mogelijkheid om het DATA 2 systeem te koppelen aan andere systemen / possibilité de connecter le système DATA 2 à d'autres systèmes
- mogelijkheid om te koppelen aan ELVIS / possibilité de se connecter à ELVIS

BELANGRIJKSTE PARAMETERS / PARAMÈTRES PRINCIPAUX

Maximum aantal noodverlichtingstoestellen in het systeem Quantité maximum d'appareils d'éclairage de secours dans le système	4096
Maximum aantal communicatiekanalen Quantité maximum de canaux de communication	64
Maximum aantal noodverlichtingstoestellen/kanaal Quantité maximum d'appareils d'éclairage de secours/canal	64
Maximum lengte van de communicatiekabel Longueur maximale du câble de communication	1000 m

Voor meer info en uitleg, raadpleeg onze website of via de QR-code.

Pour plus d'informations et d'explications, consultez notre site internet ou scannez le QR code.

PICTOGRAMMEN

Pictogrammen voor armaturen ONTEC E, ONTEC G, ONTEC S & ONTEC S30

Pictogrammes pour les luminaires ONTEC E, ONTEC G, ONTEC S & ONTEC S30



TMP 1



TMP 2



TMP 5



TMP 6



TMP 7



TMP 8



TMP 9



TMP 10



TMP 11



TMP 12



TMP 67



TMP 68



TMP 14



TMP 15



TMP 16



TMP 17



TMP 18



TMP 22



TMP 23



Waregemstraat 200 | B-8540 Deerlijk | Tel. 056 / 72 97 61
www.hvplighting.com | info@hvplighting.com