



STOCK PRODUCTS

2026 - Q01

SHINE EVO

NEW

IN STOCK



- Instelbaar vermogen 12W - 18W - 24W
- Optioneel verkrijgbaar met sensor en/of nood
- Prijs /kwaliteit scherpe aanbieding

INHOUD

LEDSTRIPS



p 1

LEDSTRIPS
COB



p 2

LEDSTRIPS
IP65- 230V



p 3

PROFIELEN+
COVERS



p 4

DRIVERS



p 5

HDR
DRIVER



p 6

E27



p 7

GU10



p 8

SWAP



p 9

ZOOM



p 12

SATURN



p 14

ZOLAN



p 15

GALEX



p 16

BARI Q



p 17

SHINE



p 18

NEW
SHINE EVO



p 19

KAMELEON



p 20

DISC



p 21

ART



p 22

AGO



p 23

TREND



p 25

DODO



p 26

DELTA



p 27

INHOUD

TAG 110



p 28

PIXEL AS



p 29

APOLLO
IP66



p 30

SINTRA



p 31

STIO



p 32

MIRROR



p 33

ELEMENT



p 34

ORION



p 35

NEW

PRIMA ML



p 36

FUTURA



p 37

PRIMA LED EX



p 38

CANNON II



p 39

LANUS



p 40

LIGHTLINE



p 41

SANI



p 42

SIRO



p 43

SIGMA II



p 44

ONTEC



p 46

NANOTTICA



p 50

LEDSTRIPS



Colour	Power/m	Length	Width	Input	Lm/m	LED/m	Cuttable Length	Ref.
2700K	9,6W/m	5m	8mm	DC 24V	1170	140	50mm	T14.140-5M-2700K
3000K	9,6W/m	5m	8mm	DC 24V	1270	140	50mm	T14.140-5M-3000K
4000K	9,6W/m	5m	8mm	DC 24V	1300	140	50mm	T14.140-5M-4000K
2700K	14,4W/m	5m	10mm	DC 24V	1740	210	33,3mm	T14.210-5M-2700K
3000K	14,4W/m	5m	10mm	DC 24V	1880	210	33,3mm	T14.210-5M-3000K
4000K	14,4W/m	5m	10mm	DC24V	1940	210	33,3mm	T14.210-5M-4000K
2700K	20,2W/m	5m	10mm	DC 24V	2700	224	33,3mm	T14.224-5M-2700K
3000K	20,2W/m	5m	10mm	DC 24V	2790	224	33,3mm	T14.224-5M-3000K
4000K	20,2W/m	5m	10mm	DC24V	2885	224	33,3mm	T14.224-5M-4000K

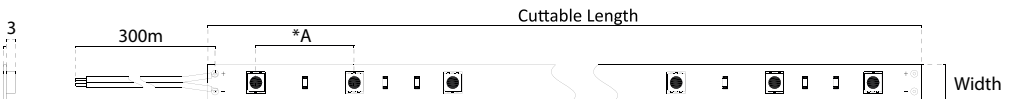

LEDSTRIPS COB



Colour	Power/m	Length	Width	Input	Lm/m	LED/m	Cutttable Length	Ref.
2700K	14,4W/m	5m	10mm	DC 24V	1300	504	41,6mm	T14.504-5M-2700K
3000K	14,4W/m	5m	10mm	DC 24V	1350	504	41,6mm	T14.504-5M-3000K
4000K	14,4W/m	5m	10mm	DC 24V	1400	504	41,6mm	T14.504-5M-4000K



LEDSTRIP IP65-230V

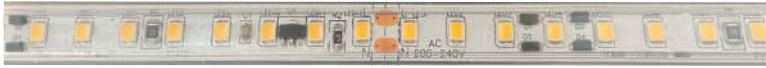

Colour	Power/m	Length	Width	Input	Lm/m	LED/m	Cuttable Length	Ref.
3000K	15W/m	1m	12mm	DC 230V	1425	95	100mm	E03.21412SP-C/1M
4000K	15W/m	1m	12mm	DC 230V	1425	95	100mm	E03.21412SP-N/1M

- * No driver
- * Phase cut dimmable
- * Customizable length up to 50m/ cuttable every 10cm
- * Available on 50m roll
- * Compatible profile p13-2

Option : Connection set

E03.21490

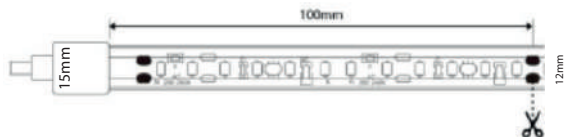

PROFIPLUS

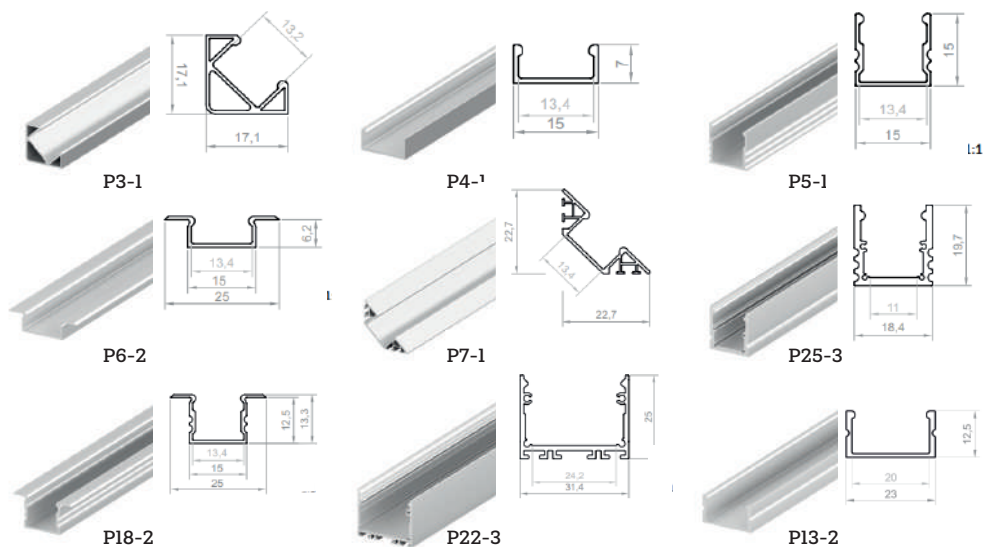

COVERS

	Colour	Length	■	□	■		Colour	Length
P3-1	■	2M				C13	□	2M
P4-1	■ □ ■	2M				C13	■ □	2M
P4-1	■ □ ■	3M				C13	■ □	3M
P5-1	■ □ ■	2M				C13	■ □	2M
P5-1	■ □ ■	3M				C13	■ □	3M
P6-2	■ □ ■	2M				C13	■ □	2M
P6-2	■ □ ■	3M				C13	■ □	3M
P7-1	■ □ ■	2M				C13	■ □	2M
P13-2	■ ■	2M				C15	□	2M
P13-2	■ ■	3M				C15	□	3M
P18-2	■ □ ■	2M				C13	■ □	2M
P22-3	■	2M				C7	□	2M
P25-3	■ □ ■	2M				C9	□	2M

*Cover C13 & C15 ook verkrijgbaar op rol van 10m

24V-DRIVERS



LPV - 24

	W	IP	A	Input	Output	(l x b x h) Dimensions	Ref.
Meanwell Driver 20	20W	IP67	0,84A	100-240V	24V	120x35x26	L02.LPV-20-24
Meanwell Driver 35	35W	IP67	1,50A	100-240V	24V	150x40x30	L02.LPV-35-24
Meanwell Driver 60	60W	IP67	2,50A	100-240V	24V	165x43x33	L02.LPV-60-24
Meanwell Driver 100	100W	IP67	4,50A	100-240V	24V	190x52x37	L02.LPV-100-24
Meanwell Driver 150	150W	IP67	4,50A	100-240V	24V	195x64x40	L02.LPV-150-24

HLG - 24B

	W	IP	A	Input	Output	(l x b x h) Dimensions	Ref.
Meanwell Driver 100H	100W	IP67	4,00A	100-240V	24V	220 x 68x 38,8	L02.HLG-100H-24B
Meanwell Driver 120H	120W	IP67	5,00A	100-240V	24V	220 x 68 x 38,8	L02.HLG-120H-24B
Meanwell Driver 185H	150W	IP67	6,30A	100-240V	24V	220 x 68 x 38,8	L02.HLG-185H-24B
Meanwell Driver 240H	240W	IP67	10,00A	100-240V	24V	244 x 68 x 38,8	L02.HLG-240H-24B

PWM DALI - 24

	W	IP	A	Input	Output	(l x b x h) Dimensions	Ref.
PWM-60	60W	IP67	3,15A	100-240V	24V	180x35x63	L02.PWM-60-24DA2
PWM-90	90W	IP67	4,00A	100-240V	24V	199x35x63	L02.PWM-90-24DA2
PWM-120	120W	IP67	6,25A	100-240V	24V	219x35x39	L02.PWM-120-24DA2
PWM-200	200W	IP67	10,00A	100-240V	24V	244x37x71	L02.PWM-200-24DA2

DIM PHASE CUT - 24

	W	IP	A	Input	Output	(l x b x h) Dimensions	Ref.
DRIVER	80W	IP66	4,00A	100-240V	24V	230x70x43	L02.KVF-24080-TDH
DRIVER	150W	IP66	4,00A	100-240V	24V	230x70x43	L02.KVF-24150-TDH

HDR DRIVER



HDR

	W	IP	A	Input	Output	(l x b x h) Dimensions	Ref.
Meanwell Driver HDR	60W	IP20	2,50A	100-240V	24V	61x67x96	L02.HDR-60-24
Meanwell Driver HDR	100W	IP20	2,50A	100-240V	24V	61x67x96	L02.HDR-100-24
Meanwell Driver HDR	150W	IP20	2,50A	100-240V	24V	61x67x96	L02.HDR-150-24

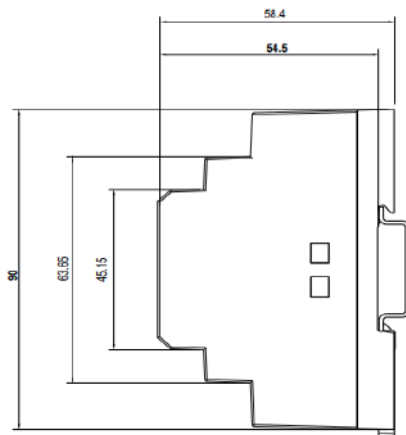

E27



	W	Lm	Color	Input	Dim.	Ref.
1 E27 Std	8W	900 Lm	2700K	220-240V	Dim	F02.8204232
2 E27 Globe Dia 95	6W	750 Lm	2500K	220-240V	Dim	F02.8204240
3 E27 Globe Dia 125	6W	710 Lm	2500K	220-240V	Dim	F02.8204239
4 E27 Edison Dia 64	4W	440 Lm	2500K	220-240V	Dim	F02.8204242
5 E27 Amber Dia 60	5W	400 Lm	2200K	220-240V	Dim	F02.8204251
6 E27 Decor spiral 64	5W	400 Lm	2200K	220-240V	Dim	F02.8204252



	W	Lm	Color	Input	Ref.
SMD-10W	10W	1080	4000K	175-250V	L14.10041
SMD-10W	15W	1500	3000K	100-250V	L14.10352

GU10



	W	Lm	Color	Beam	Ref.
--	---	----	-------	------	------

Gu10 Par16	7,5W	600lm	2700K	38°	L14.10220
------------	------	-------	-------	-----	-----------

Gu10 Par16 Dim	7,5W	600lm	2700K	38°	L14.10224
----------------	------	-------	-------	-----	-----------

Gu10 Par16	7,5W	620lm	3000K	38°	L14.10221
------------	------	-------	-------	-----	-----------

Gu10 Par16 Dim	7,5W	620lm	3000K	38°	L14.10225
----------------	------	-------	-------	-----	-----------

Gu10 Par16	7,5W	640lm	4000K	38°	L14.10222
------------	------	-------	-------	-----	-----------

SWAP S



	W	IP	CT	Flux	⊕	Color	Ref.
Swap S	5W	IP20	3000K	700	62	□	A03.A2121111W
Swap S	7W	IP20	3000K	940	62	□	A03.A2121211W
Swap S DIM PH.CUT	7W	IP20	3000K	940	62	□	A03.A2121221W

*incl vergrootring



Swap S

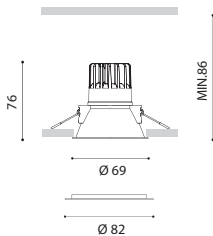

Ø 62-78

SWAP M



	W	IP	CT	Flux	Ⓡ	Color	Ref.
Swap M	5W	IP20	2700K	675	75	□	A03.A2122110W
Swap M	5W	IP20	3000K	700	75	□	A03.A2122111W
Swap M	7W	IP20	2700K	910	75	□	A03.A2122210W
Swap M	7W	IP20	3000K	940	75	□	A03.A2122211W
Swap M DIM.PH.CUT	7W	IP20	2700K	910	75	□	A03.A2122220W
Swap M DIM.PH.CUT	7W	IP20	3000K	940	75	□	A03.A2122221W
Swap M	5W	IP20	2700K	910	75	■	A03.A2122210N
Swap M	7W	IP20	3000K	940	75	■	A03.A2122211N
Swap M DIM.PH.CUT	7W	IP20	2700K	910	75	■	A03.A2122220N
Swap M DIM.PH.CUT	7W	IP20	3000K	940	75	■	A03.A2122221N

*incl Vergrootring



Ø 75-91

Swap M

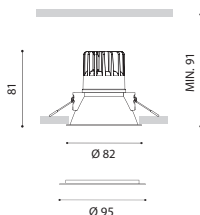

SWAP IP 65



	W	IP	CT	Flux		Color	Ref.
Swap S	7W	IP65	3000K	910	62	<input type="checkbox"/>	A03.A2121211W65
Swap M	5W	IP65	3000K	700	75	<input type="checkbox"/>	A03.A2122111W65
Swap M	7W	IP65	3000K	940	75	<input type="checkbox"/>	A03.A2122211W65
Swap M	5W	IP65	3000K	700	75	<input checked="" type="checkbox"/>	A03.A2122111N65
Swap M	7W	IP65	3000K	940	75	<input checked="" type="checkbox"/>	A03.A2122211N65

*incl Vergrooting



Swap S

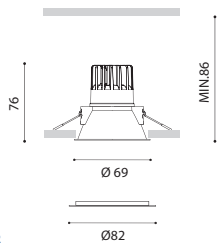

Ø 62-78

Swap M

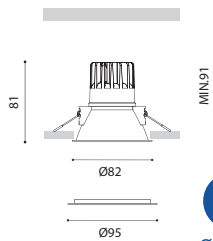

Ø 75-91

ZOOM BASE



	Ⓜ	Color	Ref.
Zoom Base square	80	□	F02.4014075
Zoom Base square	80	■	F02.4014080



	Ⓜ	Color	Ref.
Zoom Base round	80	□	F02.4014079
Zoom Base round	80	■	F02.4014084

Excl Lightbulb incl Fitting (see page 8)

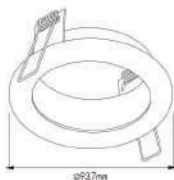
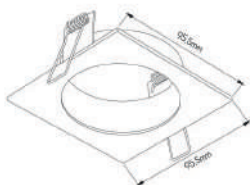

*GU10
Niet Dimbaar
Dimbaar

■ (RAL 7021)

□ (RAL 9010)

ZOOM INSERT



Color

Ref.

Zoom Insert III



F02.4014101

Zoom Insert III



F02.4014102



Color

Ref.

Zoom Insert I



F02.4014091

Zoom Insert I



F02.4014092

SATURN



	Ⓜ	Color	Ref.
Saturn Fix	60-65	□ ■	F02.4014270 F02.4014271
Saturn Tilt	70-75	□ ■	F02.4014280 F02.4014281

*Excl Lightbulb incl Fitting (see page 8)

Fix

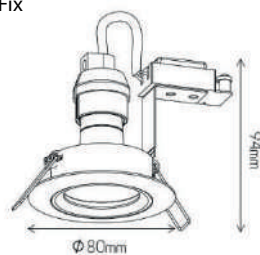

Tilt

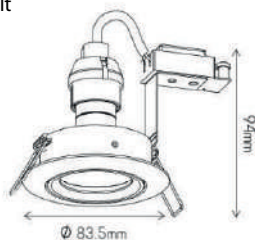

- (RAL 7021)
- (RAL 9010)



*GU10

Niet Dimbaar

Dimbaar

ZOLAN



	Hoogte	Color	Ref.
ZOLAN	110mm	□	F02.4014150
ZOLAN	110mm	■ ■	F02.4014155

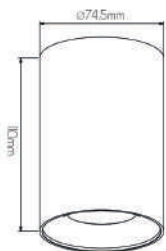

GALEX



	CT	IP	Angle Beam	Lm	Color	Ref.
Galex	3000K	IP20	30°	414	□	L09.2.17.2040
Galex	3000K	IP20	30°	414	■	L09.2.17.2043

* Phase cut dimmable

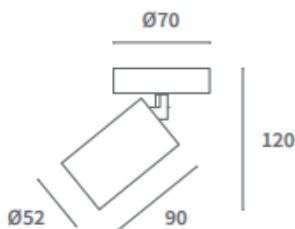

■ (RAL 7021)
□ (RAL 9010)

BARI Q



	W	IP	CT	Flux	Ⓡ	Dia	Color	Ref.
Bari Q	11W	IP44	3000K	1480	135	155mm	<input type="checkbox"/>	P08.EU001.1111.830.A000
Bari Q	11W	IP44	4000K	1510	135	155mm	<input type="checkbox"/>	P08.EU001.1111.840.A000
Bari Q	16W	IP44	3000K	2040	135	155mm	<input type="checkbox"/>	P08.EU002.1111.830.A000
Bari Q	16W	IP44	4000K	2090	135	155mm	<input type="checkbox"/>	P08.EU002.1111.840.A000
Bari Q	17W	IP44	3000K	2410	205	225mm	<input type="checkbox"/>	P08.EU003.1111.830.A000
Bari Q	17W	IP44	4000K	2460	205	225mm	<input type="checkbox"/>	P08.EU003.1111.840.A000
Bari Q	22W	IP44	3000K	2950	205	225mm	<input type="checkbox"/>	P08.EU004.1111.830.A000
Bari Q	22W	IP44	4000K	3020	205	225mm	<input type="checkbox"/>	P08.EU004.1111.840.A000

Accessories : Surface mounting housing

Bari Q LED Surface mounting housing

ØF=155mm
H=75mm

P08.FL043.11.0160

Bari Q LED Surface mounting housing

ØF=255mm
H=79mm

P08.FL043.11.0228

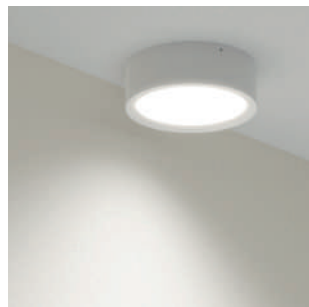
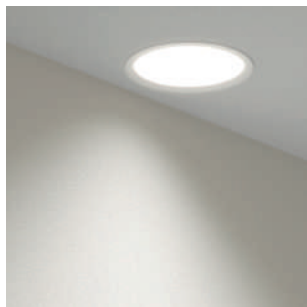

SHINE

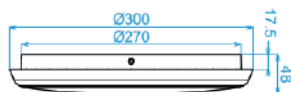

Emergency*
Lumenoutput = 4W = 350 lm

	W	IP	CT	Input	Lm	Sensor	Emergency	Ref.
Shine	25W	IP54	3000K	220-240V	2200lm			U01.AL08-12-25W-3
Shine	25W	IP54	3000K	220-240V	2200lm	●		U01.AL08-12-25W-SS-3
Shine	25W	IP54	3000K	220-240V	2200lm		●	U01.AL08-12-25W-E-3
Shine	25W	IP54	3000K	220-240V	2200lm	●	●	U01.AL08-12-25W-MS-3
Shine	25W	IP54	4000K	220-240V	2300lm			U01.AL08-12-25W
Shine	25W	IP54	4000K	220-240V	2300lm	●		U01.AL08-12-25W-SS
Shine	25W	IP54	4000K	220-240V	2300lm		●	U01.AL08-12-25W-E
Shine	25W	IP54	4000K	220-240V	2300lm	●	●	U01.AL08-12-25W-MS

SHINE MINI

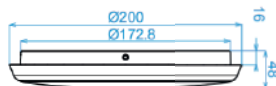

	W	IP	CT	Input	Lm	Ref.
Shine mini	12W	IP54	3000K	220-240V	1080lm	U01.AL08-8-12W-3
Shine mini	12W	IP54	4000K	220-240V	1250lm	U01.AL08-8-12W

SHINE EVO



	W*	Adjustable CCT	Lm	Ref.
Shine EVO	24W	3000K 4000K	1450lm - 3450lm	U01.SE-ST.CCT.24W
Shine EVO SENSOR	24W	3000K 4000K	1450lm - 3450lm	U01.SE-MW.CCT.24W
Shine EVO SENSOR + NOOD*	24W	3000K 4000K	1450lm - 3450lm	U01.SE-FO.CCT.24W

- * Nood 1h autotest | 280 Lm
- * Adjustable Power 12W - 18W - 24W
- * IP54

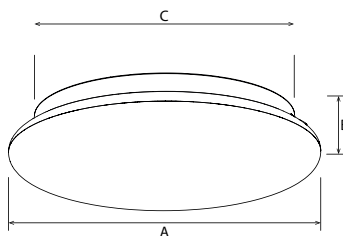

A: 300 mm
B: 85mm
C: 250mm

KAMELEON



	W	IP	CT	Dimensions	Lm	Ref.
Kameleon Square	10W 13W 16W	IP20	3000K 4000K 5700K	235mm	1000lm - 1650lm	HVP.KAM10-16CCT S
Kameleon Round	10W 13W 16W	IP20	3000K 4000K 5700K	235mm	1000lm - 1650lm	HVP.KAM10-16CCT R



	W	IP	CT	Dimensions	Lm	Ref.
Kameleon Round SENSOR	10W 13W 16W	IP20	3000K 4000K 5700K	235mm	1000lm - 1650lm	KAMELEON-SENS-3CCT

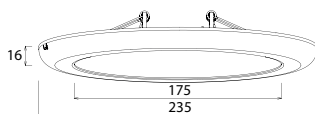

DISC SLIM



	W	IP	CT	Dimensions/H	Lm	Color	Ref.
Disc Slim	12W	IP20	3000K	145mm/ 35mm	1170lm	□	B03.K51700.02
Disc Slim Q	12W	IP20	3000K	145mm/35mm	1210lm	□	B03.K51701.02



	W	IP	CT	Dimensions/H	Lm	Color	Ref.
Disc Slim	24W	IP43	3000K	300mm/40mm	2350lm	□	K02.K51700.04.SR.WH-WH.OP.ST.8.30
Disc Slim	24W	IP43	3000K	300mm/40mm	2350lm	■	K02.K51700.04.SR.BK-BK.OP.ST.8.30

ART

ART 100

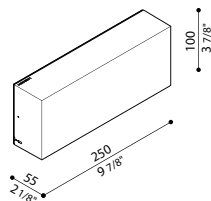

	W	IP	CT	Input	Lm	Color	Ref.
Art 100	10W	IP66	3000K	220-240V	800lm	<input type="checkbox"/>	L08.LL1160003
Art 100	10W	IP66	4000K	220-240V	800lm	<input type="checkbox"/>	L08.LL116000N

ART 250

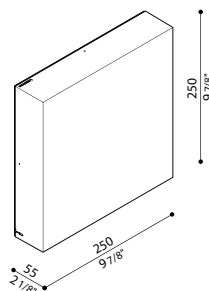

	W	IP	CT	Input	Lm	Color	Ref.
Art 250	20W	IP66	3000K	220-240V	1650lm	<input type="checkbox"/>	L08.LL1161003
Art 250	20W	IP66	4000K	220-240V	1650lm	<input type="checkbox"/>	L08.LL116100N

AGO GARDEN

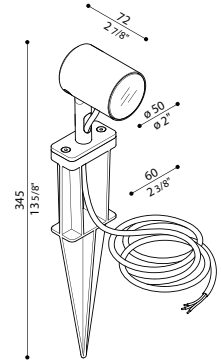
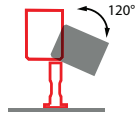

	W	IP	CT	Input	Lm	Color	Ref.
Ago Garden	6W	IP66	3000k	220-240V	568Lm	■	L08.LL126001M34

INCL 5M CABLE

AGO WALL

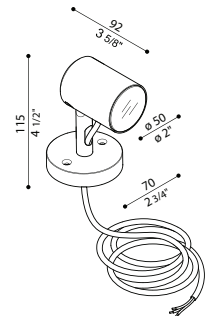
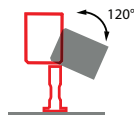

	W	IP	CT	Input	Lm	Color	Ref.
Ago Wall	6W	IP66	3000k	220-240V	568Lm	■	L08.LL126005M3

■ (RAL 9005)

AGO UP

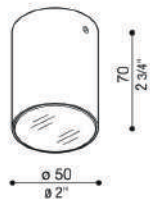

	W	IP	CT	Input	Lm	Color	Ref.
Ago Up	5W	IP66	3000k	220-240V	497Lm	■	L08.LL12640BM3
Ago Up	5W	IP66	3000k	220-240V	497Lm	□	L08.LL12640WM3

□ (RAL 9010)

■ (RAL 9005)



TREND

TREND 60

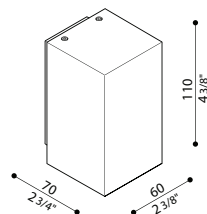

	w	IP	CT	Input	Lm	Color	Ref
Trend 60	3W	IP66	3000K	220-240V	500lm	Antra.	L08.LL1290023
Trend 60	3W	IP66	3000K	220-240V	500lm	Black	L08.LL1290263

TREND 60 U&D

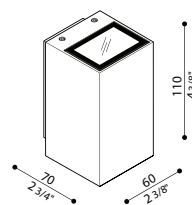

	W	IP	CT	Input	Lm	Color	Ref.
Trend 60 U&D	6W	IP66	3000K	220-240V	1000lm	Black	L08.LL1291283

- (RAL 7021)
- (RAL 9005)

DODO

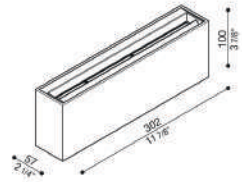

	w	iP	CT	Input	Lm	Color	Ref
Dodo 300	20W	IP54	3000K	220-240V	1220lm	Dark Antra.	L08.LL14305D3

■ (RAL 7021)

DELTA ((•••))



	W	IP	CT	Dimensions	Lm	Ref.
Delta 1	37W	IP66	3000K	200 x 276mm	5800lm	L08.LL15411BS13
Delta 1	37W	IP66	4000K	200 x 276mm	5800lm	L08.LL15411BS1N

	W	IP	CT	Dimensions	Lm	Ref.
Delta 1 SENSOR	20W	IP66	3000K	200 x 276mm	2953lm	L08.LS15411BS13
Delta 1 SENSOR	20W	IP66	4000K	200 x 276mm	2953lm	L08.LS15411BS1N

	W	IP	CT	Dimensions	Lm	Ref.
Delta 1 SENSOR	30W	IP66	3000K	200 x 276mm	4066lm	L08.LS15412BS13
Delta 1 SENSOR	30W	IP66	4000K	200 x 276mm	4066lm	L08.LS15412BS1N

■ (RAL 7021)

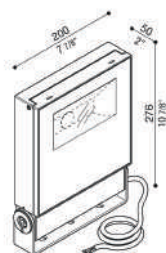

TAG 110

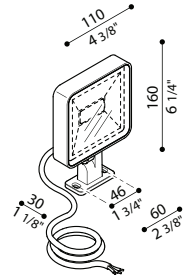

	W	IP	CT	Input	Lm	Color	Ref.
TAG 110	10W	IP66	3000K	220-240V	672lm	■	L08.LL1150023
TAG 110	10W	IP66	4000K	220-240V	672lm	■	L08.LL115002N

TAG 210

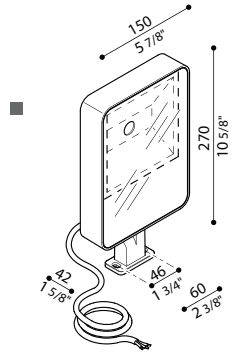

	W	IP	CT	Input	Lm	Color	Ref.
TAG 210	25W	IP66	3000K	220-240V	2585lm	■	L08.LL1151023
TAG 210	25W	IP66	4000K	220-240V	2585lm	■	L08.LL115102N

■ (RAL 7021)

PIXEL AS



	W	IP	CT	Lm	Color	Ref.
PIXEL AS	70W	IP66	4000K	10400lm	■	C01.236643.208
PIXEL AS	105W	IP66	4000K	15600lm	■	C01.236643.312
PIXEL AS	140W	IP66	4000K	20800lm	■	C01.236643.416

* T - adapter Palo

C01.920003.006

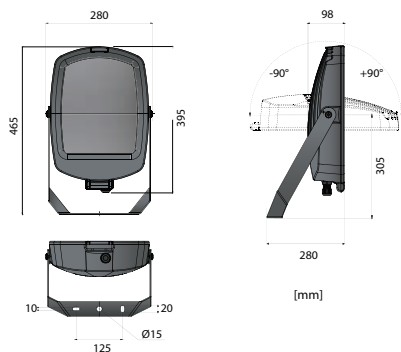

■ (RAL 7021)

APOLLO IP66



	W	Lm/W	CT	Beam Angle	Lm	Ref.
Apollo IP66	100W	160lm/w	4000K	90°	16000lm	S17.XJ-FLE100W-M
Apollo IP66	150w	160lm/w	4000K	90°	24000lm	S17.XJ-FLE150W-M
Apollo IP66	200w	160lm/w	4000K	90°	32000lm	S17.XJ-FLE200W-M

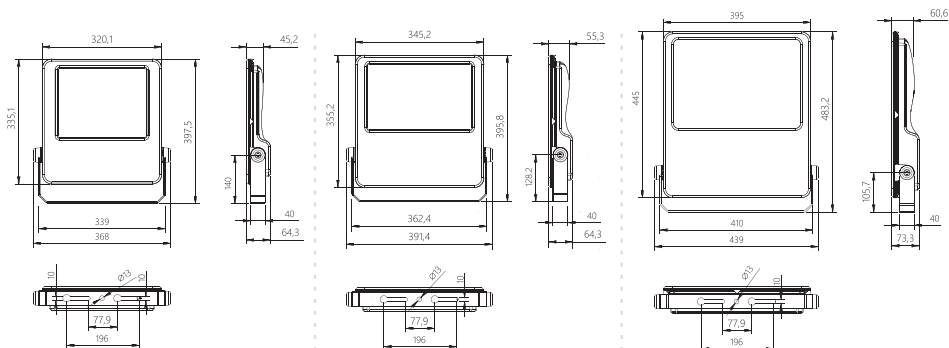

100 w

150 w

200 w

SINTRA



	W	IP	CT	Reflector	Lm	Color	Ref.
Sintra	7W	IP20	3000K	33°	722lm	□	L09.2.17.1848
Sintra	7W	IP20	3000K	33°	722lm	■	L09.2.17.1851
Sintra	15W	IP20	3000K	33°	1440lm	□	L09.2.17.1857
Sintra	15W	IP20	3000K	33°	1400lm	■	L09.2.17.1860
Sintra	27W	IP20	3000K	40°	2902lm	□	L09.2.17.1866
Sintra	27W	IP20	3000K	40°	2902lm	■	L09.2.17.1869

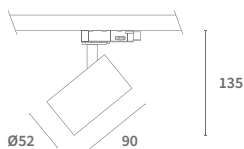

Sintra 7W

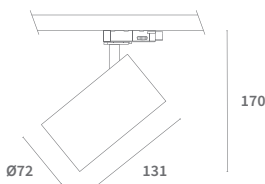

Sintra 15W

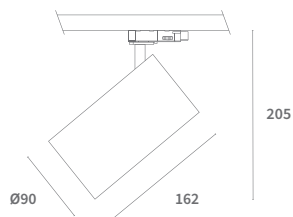

Sintra 27W

STIO



	W	IP	CT	Lm	Color	Reflector	Ref.
Stio	22,5W	IP20	3000K	3214m	□	36°	L09.2.17.4681
Stio	22,5W	IP20	3000K	3214lm	■	36°	L09.2.17.4682

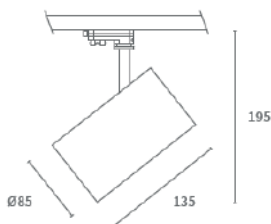

MIRROR



	W	IP	CT	Power	Lm	Color	Ref.
Mirror LED	11W	IP44	3000K	220-240V	1350lm	□	P08.AL001.1111.830.A000
Mirror LED	11W	IP44	3000K	220-240V	1350lm	■	P08.AL001.2211.830.A000
Mirror LED	11W	IP44	3000K	220-240V	1350lm	■	P08.AL001.3311.830.A000

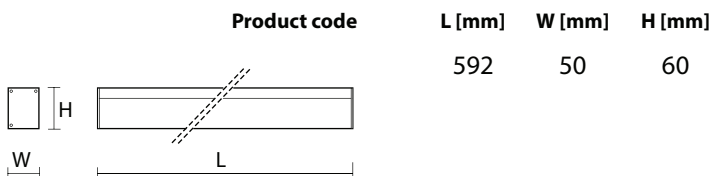

ELEMENT



	W	IP	CT	Input	Lm	lm/w	Ref.
ELEMENT 595x595	35W	IP40	3000K	220-240V	3895lm	111lm/W	S02.ELEM-60-3000K
ELEMENT 595X595	35W	IP40	4000K	220-240V	4006lm	114lm/W	S02.ELEM-60-4000K

	Ref.
SURFACE MOUNTED FRAME 600x600	P08.FL011.11.6060
EMERGENCY BAT. KIT	T04.1720120688
DALI DRIVER	S02.ELEM-OPT-DALI

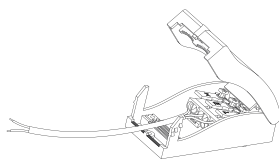

QUICK CONNECTOR INCL

A	B	C
595mm	595mm	12,5mm

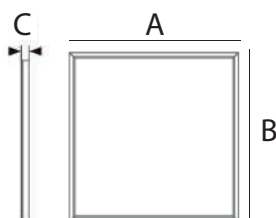

ORION



	W	IP	CT	lm	D	L	Ref.
ORION	40W	IP67	3000K	6556	81	1380	A10.OR223

ACCESSOIRE

Quick opening stainless steel clamps

A10.Q0348

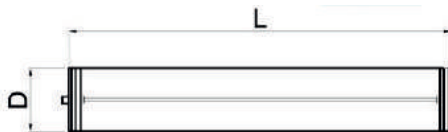

L: 1380mm
D: 81mm

PRIMA ML (multilumen)



STANDARD

	ARTIKELNR	LUMENOUTPUT										length	
		9W	11W	13W	14W	25W	27W	33W	39W	40W	47W		
PRIMA S	107391	1290	1600	1900	2190	-	-	-	-	-	-	615mm	
PRIMA M	107394	-	-	-	-	3600	4440	5250	6050	-	-	1175mm	
PRIMA L	107397	-	-	-	-	-	4440	5480	-	6480	7460	1455mm	



SENSOR

	ARTIKELNR	LUMENOUTPUT										length	
		9W	11W	13W	14W	25W	27W	33W	39W	40W	47W		
PRIMA M	901993	-	-	-	-	3600	4440	5250	6050	-	-	1175mm	
PRIMA L	901994	-	-	-	-	-	4440	5480	-	6480	7460	1455mm	

EMERGENCY M3h AT

	ARTIKELNR	LUMENOUTPUT										length	
		9W	11W	13W	14W	25W	27W	33W	39W	40W	47W		
PRIMA M	107416	-	-	-	-	3600	4440	5250	6050	-	-	1175mm	
PRIMA L	107419	-	-	-	-	-	4440	5480	-	6480	7460	1455mm	

EMERGENCY M3h AT + SENSOR

 	ARTIKELNR	LUMENOUTPUT										length	
		9W	11W	13W	14W	25W	27W	33W	39W	40W	47W		
PRIMA M	901995	-	-	-	-	3600	4440	5250	6050	-	-	1175mm	
PRIMA L	901996	-	-	-	-	-	4440	5480	-	6480	7460	1455mm	



* Inox Clips

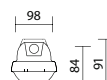
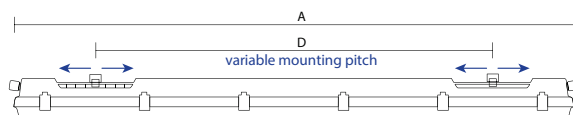

FUTURA



	W	Lm	lm/W	A	D	Ref.
FUTURA 2.4ft PCc Al 8800/840	49W	8690	159	1172	700	T04.75260
FUTURA 2.5ft PCc Al 11000/840	71W	12310	163	1452	940	T04.75290
FUTURA 2.5ft PCc Al 16000/840	102W	17440	160	1452	940	T04.75440

IP66



* Inox Clips



PRIMA LED EX



	W	Lm	lm/W	A	D	Ref.
PRIMA LED Ex 1.4ft PCc 3200/840	23W	3620	145	1272	700	T04.14810
PRIMA LED Ex 2.4ft PCc 6400/840	43W	7300	156	1272	700	T04.14850



PRIMA LED Ex 1.4ft PCc 3200/840 M1h	23W	3620	145	1272	700	T04.14814
PRIMA LED Ex 2.4ft PCc 6400/840 M1h	43W	7300	156	1272	700	T04.14854

* Inox Clips

IP66



II 3G Ex nR IICT6 Gc
II 3D Ex tc IIIC T70°C Dc

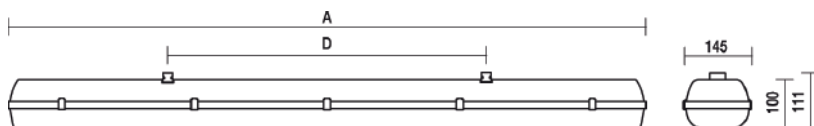

CANNON II



	W	IP	CT	Beam Angle	Lm	Lm/W	Ref.
Cannon II	200W	IP65	4000K	120°	32550lm	160 lm/W	S14.CANNON II 200W

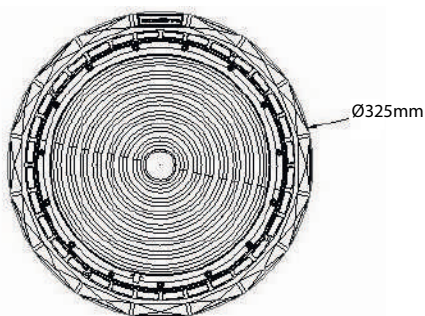
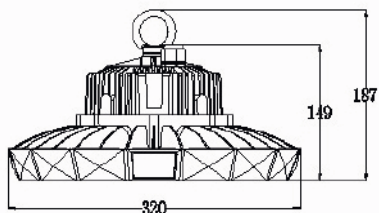

LANUS



	W	IP	CT	Beam Angle	Lm	Lm/W	A.	Ref.
Lanus Round M	150W	IP65	4000K	90°	24480lm	155 lm/W	345	T04.106904

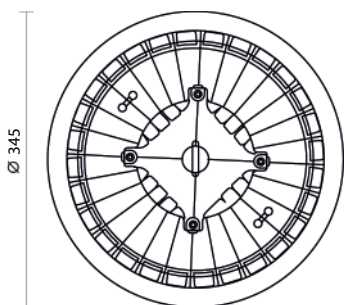

LIGHTLINE



	W	IP	CT	Beam Angle	Lm	input	Ref.
Lightline	8W	IP42	3000K	160°	870lm	220-240V	U01.Light-line-8W
Lightline	18W	IP42	3000K	160°	940lm	220-240V	U01.Light-line-18W

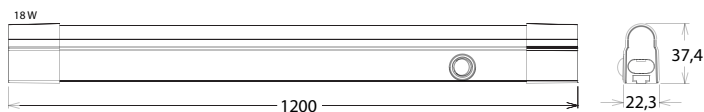
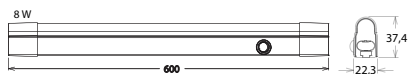

SANI



	W	IP	CT	Angle Beam	Lm	Color	Ref.
Sani	15W	IP54	3000K	60°	1300lm	□	U01.DL38-15W-D-3W
Sani	15W	IP54	3000K	60°	1300lm	■	U01.DL38-15W-D-3B

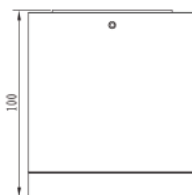
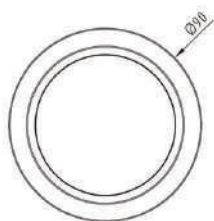

SIRO



Color

Ref.

Siro 1xGU10



U01.SIRO1

Siro 2xGU10



U01.SIRO2

Siro 3xGU10



U01.SIRO3

* Excl.Gu10

*GU10

Niet Dimbaar

Dimbaar

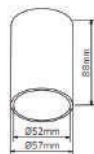
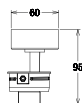
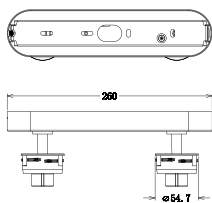
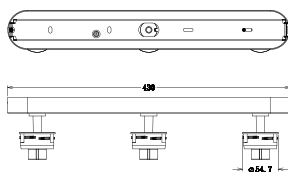

SIGMA II LED



	W	CT	Input	Lm	Color	L x W x H Dimensions	Ref.
Sigma II Led	25W	3000K	220-240V	2330lm	□ ■	1085x57x75	P08.AR002.xx11.830.A020
Sigma II Led	36W	3000K	220-240V	3600lm	□ ■	1625x57x75	P08.AR003.xx11.830.A020
Sigma II Led	48W	3000K	220-240V	4850lm	□ ■	2170x57x75	P08.AR004.xx11.830.A020

* Opal cover + Throughwiring

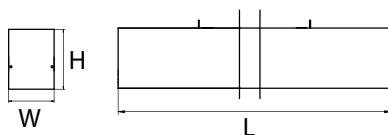

See Accessories p 46

SIGMA II ACCESSOIRES



Electrical suspension
Pieces in set: 1

P08.FS002.11.1500



P08.FS002.33.1500



Simple Suspension
Pieces in Set:1

P08.FS001.00.1500



Sigma II End cap PC
Pieces in set : 1

P08.FE004.11.0000



P08.FE004.33.0000



Sigma Invisible linear Joint Set (2pcs)
Pieces in set :2

P08.FJ002.00.0000



ONTEC S



Flag AKC.OS06



	Lens	W	Lm	Mode	Temp.Range		Ref.
Ontec S M1	Antipaniek	3W	360	M/NM	0° 40°	Autotest	T13.OS.M1ATM660W
Ontec S M1 BLACK	Antipaniek	3W	360	NM	0° 40°	Autotest	T13.TM-OS.M1ATM660B
Ontec S M5	Antipaniek	5W	576	M/NM	0° 40°	Autotest	T13.TM-OS.M5ATM160W
Ontec S M2 COLD	Antipaniek	3W	241	NM	-15° 40°	Autotest	T13.TM-OS.M2ATM16CW

Ref.

Recess.Mounting set

T13.TM-AKC.UN000

Flag Ontec S

T13.TM-AKC.OS06



M: Maintained
NM: Non-Maintained

ONTEC C



	Lens	W	Lm	Mode	Temp.Range		Ref.
Ontec C M1	Antipaniek	3w	338	NM	10° 35°	Autotest	T13.TM-OC.M1ATN600W
Ontec C C1	Vluchtweg	3w	297	NM	10° 35°	Autotest	T13.TM-OC.C1ATN600W

Acc.ontec c body colour Black

T13.PP.MS.OC001



NM: Non-Maintained

ONTEC R

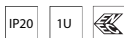

	Lens	W	Lm	Mode	Temp.Range		Ref.
Ontec R M1	Antipaniek	2W	360	NM	10° 35°	Autotest	T13.TM-OR.M1ATN600W
Ontec R C1	Vluchtweg	2W	306	NM	10° 35°	Autotest	T13.TM-OR.C1ATN600W

* acc recess. mounting set Ontec R

T13.TM-AKC.OR00W

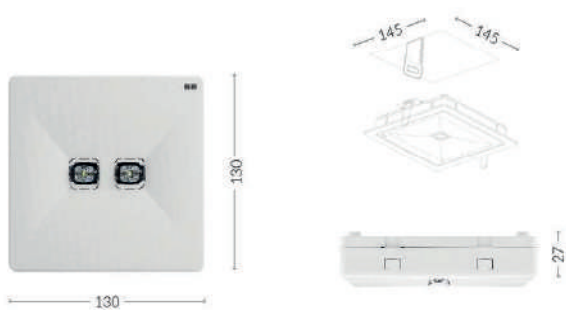

NM: Non-Maintained

ONTEC G



	Lens	W	Lm	Mode	Temp.Range		Ref.
Ontec G E1E	Antipaniek	2w	>300 cd/m ²	M	10° 35°	Autotest	T13.TM-OG.EEATM800W

* acc recess. mounting set Ontec G

T13.TM-AKC.OG00W



M: Maintained

NANOTTICA



	W	Lm	lm/W	A	D	Ref.
Nanottica 1.4ft PCc 2600/840	16W	2440	152	1170	700-960	T04.100072
Nanottica 1.4ft PCc 3200/840	20W	2910	146	1170	700-960	T04.100073
Nanottica 1.5ft PCc 3250/840	20W	3050	156	1455	970-1230	T04.100076
Nanottica 1.5ft PCc 4000/840	24W	3620	155	1455	970-1230	T04.100077
Nanottica 1.5ft PCc 5500/840	33W	5020	154	1455	970-1230	T04.100078
Nanottica 1.4ft PCc 2600/840 M1h	16W	2440	152	1170	700-960	T04.100105
Nanottica 1.5ft PCc 4000/840 M1h	26W	4000	155	1170	700-960	T04.100110
Nanottica 1.4ft PCc 3200/840 M3h	20W	3100	152	1170	700-960	T04.100114
Nanottica 1.4ft SNS PCc 4400/840	23W	3840	156	1170	700-960	T04.102127
Nanottica 1.5ft SNS PCc 5500/840	20W	4880	158	1450	970-1230	T04.102131
Nanottica 1.5ft SNS PCc 8000/840	41W	7160	165	1450	970-1230	T04.102132



* Inox Clips

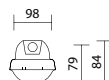
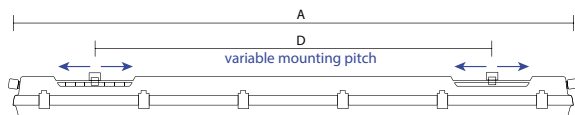

Tot einde voorraad



Groenbek 21 | B-8790 Waregem | Tel. 056/72 97 61
www.hvplighting.com | info@hvplighting.com