

STILE NEXT

- ↘ Stile next 503
- ↘ Stile next 503 asimmetrica
- ↘ Stile next 506L
- ↘ Stile next 506L asimmetrica
- ↘ Stile next 506L asimmetrica orizzontale
- ↘ Stile next 506E
- ↘ Stile next 103
- ↘ Stile next 103 asimmetrica
- ↘ Stile next 106L
- ↘ Stile next 106L asimmetrica
- ↘ Stile next 106L asimmetrica orizzontale
- ↘ Stile next 106E
- ↘ Stile next zero 60T
- ↘ Stile next zero power 60T
- ↘ Stile next zero 60Q
- ↘ Stile next zero power 60Q
- ↘ Stile next zero 120T
- ↘ Stile next zero power 120T
- ↘ Stile next zero 120Q
- ↘ Stile next zero power 120Q
- ↘ Stile next 260
- ↘ Kit-01 Stile Next Post
- ↘ Kit-02 Stile Next Post
- ↘ Kit-03 Stile Next Post
- ↘ Kit-04 Stile next Post
- ↘ Kit-05 Stile Next Post
- ↘ Kit-06 Stile Next Post
- ↘ Kit-07 Stile Next Post
- ↘ Kit-08 Stile Next Post
- ↘ Kit-09 Stile Next Post
- ↘ Kit-10 Stile Next Post
- ↘ Kit-11 Stile Next Post
- ↘ Kit-12 Stile Next Post

STILE NEXT

The range

INCASSO A MURO CON SCATOLA STANDARD

Installation with wall recessed box
Encastrement dans le mur avec boîte standards

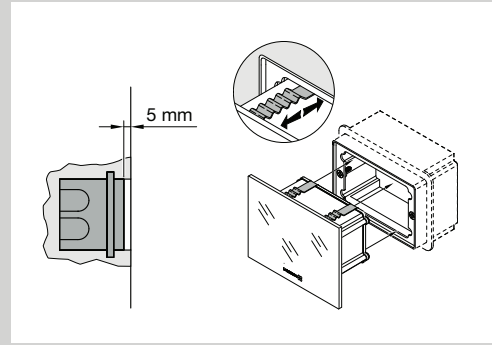

503

506E

506L

Scatole Standard
Recessed box
Boîte standards

Incasso a muro con scatola.
Consigliato incassare la scatola di 5 mm rispetto alla parete per agevolare l'installazione.

Wall recessed fixture. It is advisable to mount the box with a 5mm. recess compared with the wall to facilitate installation.

Encastrement mural. Il est conseillé d'encasser la boîte de 5mm par rapport au mur pour faciliter l'installation.

INCASSO A MURO ED IN CARTONGESSO

Recessed in wall and plasterboard
Encastrement dans le mur et dans le placoplâtre

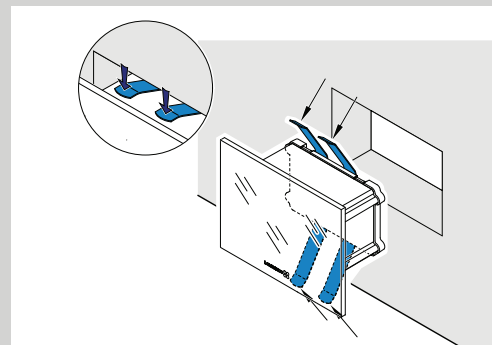

SENZA UTENSILI

Massima praticità per il montaggio ad incasso, che avviene semplicemente tramite sistema ad incastro adattabile alle diverse esigenze di profondità.

TOOL FREE

Maximum practicality for the flush-fitting assembly consisting of a recessed system that can be adapted to suit various depths.

SANS OUTILS

Grande facilité pour le montage par encastrement que l'on réalise de façon très simple au moyen d'un système d'encastrement qui s'adapte aux différentes exigences de profondeur.

Incasso a muro ed in cartongesso senza l'utilizzo di scatola.

Recessed in wall and plasterboard without any box.

Encastrement dans le mur et dans le placoplâtre sans utilisation de boîte.



503



506E



506L



**503
ASIMMETRICA**



**506L
ASIMMETRICA**



**506L
ASIMMETRICA ORIZZONTALE**



103



106E



106L



**103
ASIMMETRICA**



**106L
ASIMMETRICA**



**106L
ASIMMETRICA ORIZZONTALE**

STILE NEXT

Installazione
Installation
Installation

Incasso parete
Wall recess
Encastrement au mur

Materiali
Materials
Materiels

Materiale Corpo: Alluminio | Tipo di diffusore: Vetro serigrafato
Material: Aluminium | Diffuser type: Serigraphed glass
Matériel du corps: Aluminium | Type de diffuseur: Verre sérigraphié

Alimentazione
Power supply
Alimentation

220-240 V



STILE NEXT
503



STILE NEXT
503 ASIMMETRICA



STILE NEXT
506L



STILE NEXT
506L ASIMMETRICA



STILE NEXT
506L ASIMMETRICA
ORIZZONTALE



STILE NEXT
506E



COLOURS



Serigrafia Nera
Black serigraphy
Sérigraphie noir



Serigrafia Grigio High Tech
Grey High Tech Serigraphy
Sérigraphie Gris High Tech



Serigrafia Corten
Corten serigraphy
Sérigraphie Corten



Neutro
Neutral
Neutre

Stile next 503

IP66 IK 06 1J xx3 CE UK ER	LED			COL.	CODE *	
	W	LM	REAL LM			
	3	310	68		LL641C□	
					LL641C2□	
					LL641CG□	
					LL641CK□	
6	720	170		LL641D□		

* Complete the CODE LED COLOUR N | 4000K 3 | 3000K 2 | 2700K

Predisposto per singolo ingresso alimentazione. | Single cable entry at the back. | Entrée d'alimentation simple.

Stile next 503 asimmetrica

IP66 IK 06 1J xx3 CE UK ER	LED			COL.	CODE *	
	W	LM	REAL LM			
	3	310	45		LL643C□	
					LL643C2□	
					LL643CG□	
					LL643CK□	

* Complete the CODE LED COLOUR N | 4000K 3 | 3000K 2 | 2700K

Predisposto per singolo ingresso alimentazione. Deflettore in alluminio primario pressofuso EN-AB4+100. | Single cable entry at the back. Reflector made of EN-AB4+100 die-cast aluminium primary alloy. | Entrée d'alimentation simple. Réflecteur en aluminium primaire injecté EN-AB4+100.

Stile next 506L

IP66 IK 06 1J xx3 CE UK ER	LED			COL.	CODE *	
	W	LM	REAL LM			
	6	720	217		LL661D□	
					LL661D2□	
					LL661DG□	
					LL661DK□	

* Complete the CODE LED COLOUR N | 4000K 3 | 3000K 2 | 2700K

Predisposto per doppio ingresso alimentazione. | Double cable entry at the back. | Possibilité alimentation double entrée.







Stile next 506L asimmetrica

IP66 IK 06 1J xx3 CE UK ER	LED			COL.	CODE *	
	W	LM	REAL LM			
	3	310	38		LL663C□	

* Complete the CODE LED COLOUR N | 4000K 3 | 3000K

Predisposto per doppio ingresso alimentazione. Deflettore in alluminio primario pressofuso EN-AB4+100. | Double cable entry at the back. Reflector made of EN-AB4+100 die-cast aluminium primary alloy. | Possibilité alimentation double entrée. Réflecteur en aluminium primaire injecté EN-AB4+100.



Stile next 506L asimmetrica orizzontale

IP66 IK 06 1J xx3 CE UK ER	LED			COL. 	CODE *	
	W	LM	REAL LM			
	4	490	70		LL665F□	
			  220-240 V		LL665F2□	
					LL665FG□	
					LL665FK□	

* Complete the CODE □ LED COLOUR N | 4000K 3 | 3000K 2 | 2700K

Predisposto per doppio ingresso alimentazione. Deflettore in alluminio primario pressofuso EN-AB44100. | Double cable entry at the back. Reflector made of EN-AB44100 die-cast aluminium primary alloy. | Possibilità alimentazione double entrée. Réflecteur en aluminium primaire injecté EN-AB44100.

Stile next 506E

IP66 IK 06 1J xx3 CE UK ER	LED			COL. 	CODE *	
	W	LM	REAL LM			
	6	720	283		LL651D□	
			  220-240 V			

* Complete the CODE □ LED COLOUR N | 4000K 3 | 3000K

Predisposto per doppio ingresso alimentazione. | Double cable entry at the back. | Possibilità alimentazione double entrée.

Palo Stile Next

Palo multifunzionale in tecnopolimero completo di coperchi amovibili (da asportare nel caso si applichino apparecchi) e relativa bulloneria. Obbligatoria l'installazione del modello 506-L, non compreso. Predisposto per accogliere anche un coperchio per presa elettrica della Bticino mod. IDROBOX LUNA IP55 - Cod. 24602L.

Post Stile Next

Multi-purpose technopolymer post complete with removable covers (to be removed to accommodate the light fixtures) and all required nuts and bolts. Model 506L must be mounted (article to be ordered separately). It has been designed to accommodate an IP rated electric socket manufactured by Bticino mod. IDROBOX LUNA IP55 - Code 24602L.

Poteau Stile Next

Poteau multifonctionnel en technopolymère avec couvercles amovibles (à retirer pour appliquer les appareils) et visserie. L'installation du modèle 506-L, non compris, est obligatoire. Il a été également conçu pour l'application d'un couvercle de la prise de courant Bticino mod. IDROBOX LUNA IP55 - Cod. 24602L.

Col.	Code
	LB11652
	LB1165G
	LB1165K

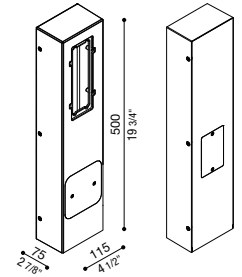

Palo Stile Next Alluminio

Palo multifunzionale per modelli Stile Next 503 - Stile Next 503 asimmetrica. Adatto per uso esterno, idoneo per applicazioni a pavimento. Struttura palo realizzata in alluminio pressofuso; elevata resistenza all'ossidazione grazie al trattamento di passivazione a base di zirconio e alla verniciatura con resine poliestere stabilizzata ai raggi UV. Bulloneria inclusa. BORDO MARE: aggiungi S alla fine del codice selezionato comprensivo di colore LED per avere il prodotto fornito con trattamento bordo mare contro le nebbie saline.

Aluminium Post Stile Next

Multi-purpose post for Stile Next 503 - Stile Next 503 asimmetrica. Suitable for outdoor use and floor installation. Post in die-cast aluminium; highly resistant to oxidation thanks to the zirconium-based passivation treatment and UV stabilized polyester resin coating. Nuts and bolts included. BORDO MARE: add S to the end of the selected code including LED colour to have the product supplied with sea treatment against salt spray.

Poteau aluminium pour Stile Next

Poteau multifonctionnel pour Stile Next 503 - Stile Next asimmetrica. Adapté à l'usage à l'extérieur et pour une application au sol. Poteau réalisé en aluminium injecté; haute résistance à l'oxydation, grâce à un traitement de passivation à base de zirconium et laquage poudre à base de résines polyesters, fixées aux rayons UV. Fixation comprise. BORDO MARE: ajoutez S à la fin du code sélectionné, y compris la couleur LED, pour que le produit soit fourni avec un traitement de bord de mer contre le brouillard salin.

Versione monoemissione
Unidirectional version
Version unidirectionnelle

Versione biemissione
Bidirectional version
Version bidirectionnelle

Col.	Code
	LB1100000
	LB1100002
	LB1100001

Col.	Code
	LB1100003
	LB1100005
	LB1100004

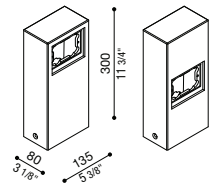

Dima e kit di fissaggio Palo Stile Next

Dima, tirafondi e minuteria per ancoraggio del palo al terreno.

Template and fixing kit for post Stile Next

Template, fixing bolts and small metal parts to secure the post to the ground.

Gabarit, tire-fond et visserie pour ancrage du poteau Stile Next

Gabarit, tire-fond et visserie pour ancrage du poteau au sol.

Col.	Code
-	LB11255

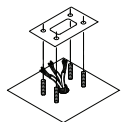

Box Alluminio 503

Box per montaggio sporgente a parete (non per incasso).
Corpo in alluminio primario pressofuso EN-AB44100; elevata resistenza all'ossidazione grazie al trattamento di passivazione a base di zirconio e alla verniciatura con resine poliesteri stabilizzata ai raggi UV.

CoL.	Code
	LB11841
	LB1184G

Box in aluminium 503
 Box for surface wall mounting (not recessed).
 Body made of EN-AB44100 die-cast aluminium primary alloy; highly resistant to oxidation thanks to the zirconium-based passivation treatment and UV stabilized polyester resin coating.

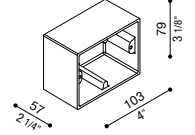

Box aluminium 503
 Box pour le montage au mur en saillie (pas à encastrement).
 Corps en aluminium primaire injecté EN-AB44100; haute résistance à l'oxydation grâce au traitement de passivation à base de zirconium et laquage poudre à base de résines polyesters, fixées au rayon UV.

Box Alluminio 506E

Box per montaggio sporgente a parete (non per incasso).
Corpo in alluminio primario pressofuso EN-AB44100; elevata resistenza all'ossidazione grazie al trattamento di passivazione a base di zirconio e alla verniciatura con resine poliesteri stabilizzata ai raggi UV.

CoL.	Code
	LB11611
	LB1161G

Box in aluminium 506E
 Box for surface wall mounting (not recessed).
 Body made of EN-AB44100 die-cast aluminium primary alloy; highly resistant to oxidation thanks to the zirconium-based passivation treatment and UV stabilized polyester resin coating.

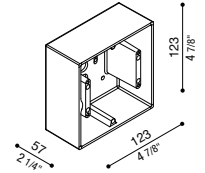

Box Aluminium 506E
 Box pour le montage au mur en saillie (pas à encastrement).
 Corps en aluminium primaire injecté EN-AB44100; haute résistance à l'oxydation grâce au traitement de passivation à base de zirconium et laquage poudre à base de résines polyesters, fixées au rayon UV.

Box Alluminio 506L

Box per montaggio sporgente a parete (non per incasso).
Corpo in alluminio primario pressofuso EN-AB44100; elevata resistenza all'ossidazione grazie al trattamento di passivazione a base di zirconio e alla verniciatura con resine poliesteri stabilizzata ai raggi UV.

CoL.	Code
	LB11621
	LB1162G

Box in aluminium 506L
 Box for surface wall mounting (not recessed).
 Body made of EN-AB44100 die-cast aluminium primary alloy; highly resistant to oxidation thanks to the zirconium-based passivation treatment and UV stabilized polyester resin coating.

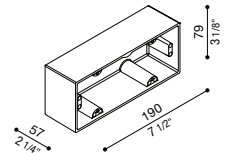

Box Aluminium 506L
 Box pour le montage au mur en saillie (pas à encastrement).
 Corps en aluminium primaire injecté EN-AB44100; haute résistance à l'oxydation grâce au traitement de passivation à base de zirconium et laquage poudre à base de résines polyesters, fixées au rayon UV.

Scatola Incasso Standard 503

Recess Box 503

Armature à encastrer standard 503

CoL.	Code
-	LB11660

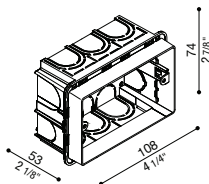

Scatola Incasso Standard 506E

Recess Box 506E

Armature à encastrer standard 506E

CoL.	Code
-	LB11670

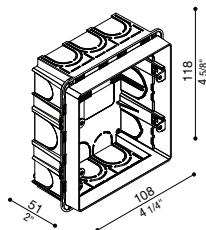

Scatola Incasso Standard 506L

Recess Box 506L

Armature à encastrer standard 506L

CoL.	Code
-	LB11680

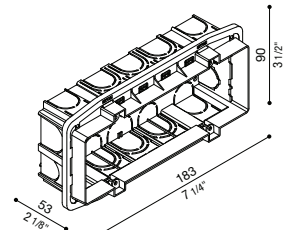



FEATURES



Ancora un passo avanti

Per l'installazione a terra Stile Next dispone di un robusto paletto in tecnopolimero, nero o verniciato in grigio high tech. Predisposto per alloggiare il modello Stile Next 506-L su un lato e integrabile sull'altro con Stile Next 503 consentendo nuovi utilizzi grazie alla doppia illuminazione; inoltre è predisposto per accogliere anche un coperchio per presa elettrica della Bticino mod. IDROBOX LUNA IP55 - Cod. 24602L.

Another step forward

For ground mounted column installation, Stile Next can offer a sturdy technopolymer post in black or coated in high tech grey. Designed to hold model Stile Next 506-L on one side, and optionally with Stile Next 503 on the other, it can also be used for new purposes thanks to the dual lighting possibility. Furthermore, it has also been designed to accommodate an IP rated electric socket manufactured by Bticino mod. IDROBOX LUNA IP55 - Code 24602L.

Encore un pas en avant

Pour l'installation au sol Stile Next dispose d'un robuste poteau en technopolymère, noir ou laqué de couleur gris High Tech. Conçu pour loger d'un côté le modèle Stile Next 506-L et de l'autre côté pour intégrer le modèle Stile Next 503; il réalise ainsi de nouvelles utilisations grâce au double éclairage; il a été également conçu pour l'application d'un couvercle de la prise de courant Bticino mod. IDROBOX LUNA IP55 - Cod. 24602L.



Disponibile anche con finitura "CORTEN"

Available with CORTEN finish
Finition CORTEN disponible



Fronte | Front | Devant



Retro | Back | Derrière

Il paletto è provvisto di coperchi amovibili, che vanno asportati nel caso si applichino gli apparecchi (non inclusi).

The post is provided with removable covers which can be removed to accommodate the luminaires (to be ordered separately).

Le poteau est muni de couvercles amovibles que l'on peut retirer quand on applique les appareils (non inclus).

STILE NEXT

Installazione
Installation
Installation

Incasso parete
Wall recess
Encastrement au mur

Materiali
Materials
Materiels

Materiale Corpo: Alluminio | Tipo di diffusore: Vetro serigrafato
Material: Aluminium | Diffuser type: Serigraphed glass
Matériel du corps: Aluminium | Type de diffuseur: Verre sérigraphié

Alimentazione
Power supply
Alimentation

Versione a led con alimentatore integrato - 24V
LED version with integrated ballast - 24V
Version LED avec alimentation intégrée - 24V



STILE NEXT
103



STILE NEXT
103 ASIMMETRICA



STILE NEXT
106L



STILE NEXT
106L ASIMMETRICA



STILE NEXT
106L ASIMMETRICA
ORIZZONTALE



STILE NEXT
106E



COLOURS



Neutro
Neutral
Neutre

Stile next 103

IP66 IK 06 1J xx3 CE UK ER	LED		REAL LM	COL.	CODE *
	W	LM			
	3	310	68	⊕ ⊖ 220-240 V	LL642C□
	6	720	170	⊕ ⊖ 220-240 V	LL642D□
	3	360	85	⊕ ⊗ 24V	LL643D□

* Complete the CODE LED COLOUR N | 4000K 3 | 3000K

Predisposto per singolo ingresso alimentazione. LL643DN/3 alimentatore escluso. | Single cable entry at the back. LL643DN/3 ballast not included. | Entrée d'alimentation simple. LL643DN/3 ballast exclus.

Stile next 103 asimmetrica

IP66 IK 06 1J xx3 CE UK ER	LED		REAL LM	COL.	CODE *
	W	LM			
	3	310	45	⊕ ⊖ 220-240 V	LL644C□

* Complete the CODE LED COLOUR N | 4000K 3 | 3000K

Predisposto per singolo ingresso alimentazione. Deflettore in alluminio primario pressofuso EN-AB44100. | Single cable entry at the back. Reflector made of EN-AB44100 die-cast aluminium primary alloy. | Entrée d'alimentation simple. Réflecteur en aluminium primaire injecté EN-AB44100

Stile next 106L

IP66 IK 06 1J xx3 CE UK ER	LED		REAL LM	COL.	CODE *
	W	LM			
	6	720	217	⊕ ⊖ 220-240 V	LL662D□
	6	720	217	⊕ ⊗ 24V	LL663D□
	3	270	94	⊕ ⊖ 220-240 V	LL6623□

* Complete the CODE LED COLOUR N | 4000K 3 | 3000K

Predisposto per doppio ingresso alimentazione. LL663DN/3 alimentatore escluso. | Double cable entry at the back. LL663DN/3 ballast not included. | Possibilité alimentation double entrée. LL663DN/3 ballast exclus.

Stile next 106L asimmetrica

IP66 IK 06 1J xx3 CE UK ER	LED			COL.	CODE *
	W	LM	REAL LM		
	3	310	38	⊕ ⊖ 220-240 V	LL664C

172x68 mm
6 3/4" x 2 5/8"

* Complete the CODE LED COLOUR N | 4000K 3 | 3000K

Predisposto per doppio ingresso alimentazione. Deflettore in alluminio primario pressofuso EN-AB44100. | Double cable entries at the back. Reflector made of EN-AB44100 die-cast aluminium primary alloy. | Possibilità alimentazione double entrée. Réflecteur en aluminium primaire injecté EN-AB44100.

Stile next 106L asimmetrica orizzontale

IP66 IK 06 1J xx3 CE UK ER	LED			COL.	CODE *
	W	LM	REAL LM		
	4	490	70	⊕ ⊖ 220-240 V	LL666F

172x68 mm
6 3/4" x 2 5/8"

* Complete the CODE LED COLOUR N | 4000K 3 | 3000K

Predisposto per doppio ingresso alimentazione. Deflettore in alluminio primario pressofuso EN-AB44100. | Double cable entry at the back. Reflector made of EN-AB44100 die-cast aluminium primary alloy. | Possibilità alimentazione double entrée. Réflecteur en aluminium primaire injecté EN-AB44100.

Stile next 106E

IP66 IK 06 1J xx3 CE UK ER	LED			COL.	CODE *
	W	LM	REAL LM		
	6	720	283	⊕ ⊖ 220-240 V	LL652D
	6	720	283	⊕ ⊖ 24V	LL653D
	3	270	96	⊕ ⊖ 220-240 V	LL6523

105x105 mm
4 1/8" x 4 1/8"

* Complete the CODE LED COLOUR N | 4000K 3 | 3000K

Predisposto per doppio ingresso alimentazione. LL653DN/3 alimentatore escluso. | Double cable entry at the back. LL653DN/3 ballast not included. | Possibilità alimentazione double entrée. LL653DN/3 ballast exclus.

Cemento Style 103

FINO A ESAURIMENTO SCORTE

Apparecchio non incluso. Struttura in cemento per installazione a pavimento relativa bulloneria.
Peso dell'accessorio in cemento con prodotto inserito: 2.7kg.
Prodotti associati: Stile Next 103 - Stile Next 103 Asimmetrica.

Cemento Style 103

Lighting fixture not included. Body made of concrete for ground application. Fixing nuts and bolts included.
 Total weight of the concrete post with product fitted inside: 2.7Kg/5.95Lb.
 Suitable for fitting with our Stile Next 103; Stile Next 103 Asimmetrica.

Cemento Style 103

Appareil non inclus. Structure en ciment pour installation au sol avec visserie (fixation).
 Poids brut du support avec bâti inclus: 2.7Kg/5.95Lb.
 Produits complémentaires: Stile Next 103 - Stile Next 103 Asimmetrica.

CoL. Code

 LB11854

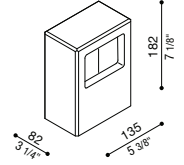

Cassaforma Polistirolo Stile Next 103

Cassaforma in polistirolo.

Polystyrene mould Stile Next 503
 Polystyrene mould.

Gabarit en polystyrène Stile Next 103
 Gabarit en polystyrène.

CoL. Code

- LB11571

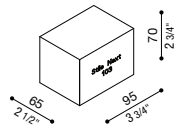

Cassaforma Polistirolo Stile Next 106L

Cassaforma in polistirolo.

Polystyrene mould Stile Next 106L
 Polystyrene mould.

Gabarit en polystyrène Stile Next 106L
 Gabarit en polystyrène.

CoL. Code

- LB11573

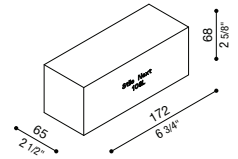

Cassaforma Polistirolo Stile Next 106E

Cassaforma in polistirolo.

Polystyrene mould Stile Next 106E
 Polystyrene mould.

Gabarit en polystyrène Stile Next 106E
 Gabarit en polystyrène.

CoL. Code

- LB11572

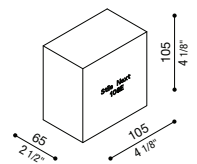



STILE NEXT 103/503 ASIMMETRICA



STILE NEXT 103/503 - STILE NEXT 506L/106L



STILE NEXT 103/503 ASIMMETRICA

STILE NEXT ZERO

Installazione
Installation
Installation

Incasso terra
Ground recess
Encastrement au sol

Materiali
Materials
Materiels

Materiale Corpo: Alluminio | Tipo di diffusore: Vetro serigrafato
Material: Aluminium | Diffuser type: Serigraphed glass
Matériel du corps: Aluminium | Type de diffuseur: Verre sérigraphié

Alimentazione
Power supply
Alimentation

220-240 V



STILE NEXT ZERO
60T



STILE NEXT ZERO
POWER 60T



STILE NEXT ZERO
60Q



STILE NEXT ZERO
POWER 60Q



STILE NEXT ZERO
120T



STILE NEXT ZERO
POWER 120T



STILE NEXT ZERO
120Q



STILE NEXT ZERO
POWER 120Q

COLOURS



Neutro
Neutral
Neutre

Stile next zero 60T

IP67 IK 10 20J xx9 CE UK CR 10 2000 ^{KG} MAX °C 60 [°] MAX	LED			COL.	CODE *
	W	LM	REAL LM		
Fino ad esaurimento. Until our stock lasts. Jusqu'à épuisement de stock.	3	230	38	220-240 V	LL104B

* Complete the CODE LED COLOUR N | 4000K 3 | 3000K

Stile next zero power 60T

IP67 IK 10 20J xx9 CE UK CR 10 2000 ^{KG} MAX °C 60 [°] MAX	LED			COL.	CODE *
	W	LM	REAL LM		
Fino ad esaurimento. Until our stock lasts. Jusqu'à épuisement de stock.	3	230	93	220-240 V	LL105B
	2	229	186	220-240 V	LL105A

* Complete the CODE OPTIC S | 13° M | 29° L | 48° LED COLOUR N | 4000K 3 | 3000K

Stile next zero 60Q

IP67 IK 10 20J xx9 CE UK CR 10 2000 ^{KG} MAX °C 60 [°] MAX	LED			COL.	CODE *
	W	LM	REAL LM		
Fino ad esaurimento. Until our stock lasts. Jusqu'à épuisement de stock.	3	230	38	220-240 V	LL134B

* Complete the CODE LED COLOUR N | 4000K 3 | 3000K

Stile next zero power 60Q

IP67 IK 10 20J xx9 CE UK CR 10 2000 ^{KG} MAX °C 60 [°] MAX	LED			COL.	CODE *
	W	LM	REAL LM		
Fino ad esaurimento. Until our stock lasts. Jusqu'à épuisement de stock.	3	230	93	220-240 V	LL135B
	2	229	186	220-240 V	LL135A

* Complete the CODE OPTIC S | 13° M | 29° L | 48° LED COLOUR N | 4000K 3 | 3000K

Stile next zero 120T

IP67 IK 10 20J xx9 CE UK CR 10 2000 KG MAX °C55° MAX	LED			COL.	CODE *
	W	LM	REAL LM		
Fino ad esaurimento. Until our stock lasts. Jusqu'à épuisement de stock.	4,5	725	260	220-240 V	LL677H□

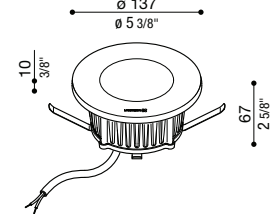

* Complete the CODE LED COLOUR N | 4000K 3 | 3000K

Stile next zero power 120T

IP67 IK 10 20J xx9 CE UK CR 10 2000 KG MAX °C70° MAX	LED			COL.	CODE *
	W	LM	REAL LM		
Fino ad esaurimento. Until our stock lasts. Jusqu'à épuisement de stock.	8	900	502	220-240 V	LL697H□
	3,5	378	305	220-240 V	LL697C□□

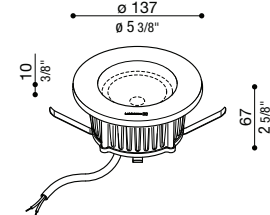

* Complete the CODE OPTIC S | 10° M | 20° L | 40° LED COLOUR N | 4000K 3 | 3000K

Stile next zero 120Q

IP67 IK 10 20J xx9 CE UK CR 10 2000 KG MAX °C55° MAX	LED			COL.	CODE *
	W	LM	REAL LM		
Fino ad esaurimento. Until our stock lasts. Jusqu'à épuisement de stock.	4,5	725	260	220-240 V	LL687H□

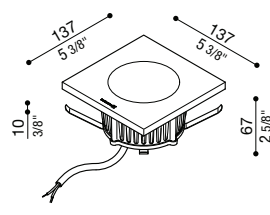

* Complete the CODE LED COLOUR N | 4000K 3 | 3000K

Stile next zero power 120Q

IP67 IK 10 20J xx9 CE UK CR 10 2000 KG MAX °C70° MAX	LED			COL.	CODE *
	W	LM	REAL LM		
Fino ad esaurimento. Until our stock lasts. Jusqu'à épuisement de stock.	8	900	502	220-240 V	LL707H□
	3,5	378	305	220-240 V	LL707C□□

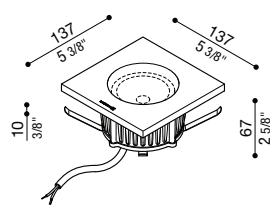

* Complete the CODE OPTIC S | 10° M | 20° L | 40° LED COLOUR N | 4000K 3 | 3000K

Armatura da incasso Stile Next Zero 60T

Armatura da incasso completa di collare superiore in acciaio inox AISI 316L, da posizionare a filo con la superficie di installazione.

CoL.	Code
-	LB11584

Recess box Stile Next Zero 60T

Recessed box complete with upper collar made of AISI 316L stainless steel, flush to the installation surface.

Boîte d'encastrement Stile Next Zero 60T

Boîte d'encastrement avec collier supérieur en acier AISI type EN-AB44100, à placer au ras de la surface de montage.

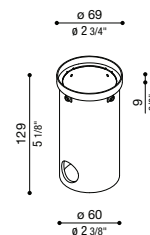

Armatura da incasso Stile Next Zero 60Q

Armatura da incasso completa di collare superiore in acciaio inox AISI 316L, da posizionare a filo con la superficie di installazione.

CoL.	Code
-	LB11583

Recess box Stile Next Zero 60Q

Recessed box complete with upper collar made of AISI 316L stainless steel, flush to the installation surface.

Boîte d'encastrement Stile Next Zero 60Q

Boîte d'encastrement avec collier supérieur en acier AISI type EN-AB44100, à placer au ras de la surface de montage.

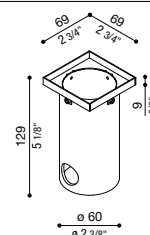

Armatura da incasso Stile Next Zero 120T

Armatura da incasso completa di collare superiore in acciaio inox AISI 316L, da posizionare a filo con la superficie di installazione.

CoL.	Code
-	LB11582

Recess box Stile Next Zero 120T

Recessed box complete with upper collar made of AISI 316L stainless steel, flush to the installation surface.

Boîte d'encastrement Stile Next Zero 120T

Boîte d'encastrement avec collier supérieur en acier AISI type EN-AB44100, à placer au ras de la surface de montage.

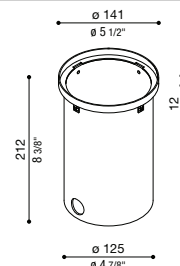

Armatura da incasso Stile Next Zero 120Q

Armatura da incasso completa di collare superiore in acciaio inox AISI 316L, da posizionare a filo con la superficie di installazione.

CoL.	Code
-	LB11581

Recess box Stile Next Zero 120Q

Recessed box complete with upper collar made of AISI 316L stainless steel, flush to the installation surface.

Boîte d'encastrement Stile Next Zero 120Q

Boîte d'encastrement avec collier supérieur en acier AISI type EN-AB44100, à placer au ras de la surface de montage.

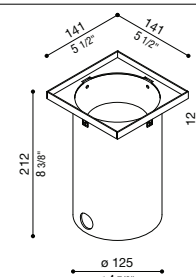

Ventosa Stile Next Zero 60T-60Q

Ventosa per estrazione modelli Stile Next Zero.

Sucker Stile Next Zero 60T-60Q

Suction cup to extract the models Stile Next Zero.

Vetouse pour extraction Stile Next Zero 60T-60Q

Vetouse pour extraction pour les modèles Stile Next Zero.

CoL.	Code
-	LB11191



Ventosa Stile Next Zero 120T-120Q

Ventosa per estrazione modelli Stile Next Zero

Sucker Stile Next Zero 120T-120Q

Suction cup to extract the models Stile Next Zero.

Vetouse pour extraction Stile Next Zero 120T-120Q

Vetouse pour extraction pour les modèles Stile Next Zero.

CoL.	Code
-	LB11190



Morsettiera coassiale

Morsettiera coassiale a 3 poli, IP68, per cavo \varnothing 7/12 mm.

CoL.	Code
-	LB11293

Coaxial Terminal block

Coaxial 3-pole terminal block, IP68, for cable diameter 7/12 mm.

Bornier coaxial

Bornier coaxial à 3 pôles, IP68, pour câble diam. 7/12 mm.

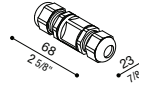

Morsettiera lineare a 3 vie

Morsettiera lineare a 3 vie a 3 poli, IP68, per cavo \varnothing 7/13,5 mm.

CoL.	Code
-	LB11294

3 way linear terminal block

3-way 3-pole linear terminal block, IP68, for cable \varnothing 7/13.5 mm.

Bornier linéaire 3 voies

Bornier linéaire 3 voies à 3 pôles, IP68, pour câble diam. 7/13,5 mm.

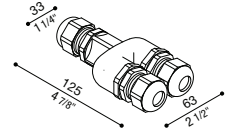

FEATURES

Diffusore in vetro temprato e serigrafato ad alto spessore 10 mm
Heat tempered and serigraphed glass diffuser, 10 mm thickness
Diffuseur en verre trempé et sérigraphié, épaisseur 10 mm

Doppio strato resinatura ad alta tenuta
Double layer of high resistant resin
Double couche de résine à haute résistance

Corpo in alluminio pressofuso EN-AB44100
Body made of EN-AB44100 die-cast aluminium primary alloy
Corps en aluminium moulé sous pression EN-AB44100

Resinatura posteriore
Back resin
Couche de résine postérieure

Molle di ritenuta per ancoraggio prodotto
Retaining springs
Ressorts de retenue pour ancrage

Cavo di alimentazione H05RN-F pre-cablato da 3 m
3 Metre pre-wired cable type H05RN-F
Câble d'alimentation H05RN-F pré-câblé de 3 m

Armatura da incasso in acciaio AISI 316L
Recessed box made of AISI 316L stainless steel
Armature d'encastrement en acier AISI 316L

Bulloneria in acciaio Inox A4
Nuts and bolts in A4 stainless steel
Fixation en acier Inox A4

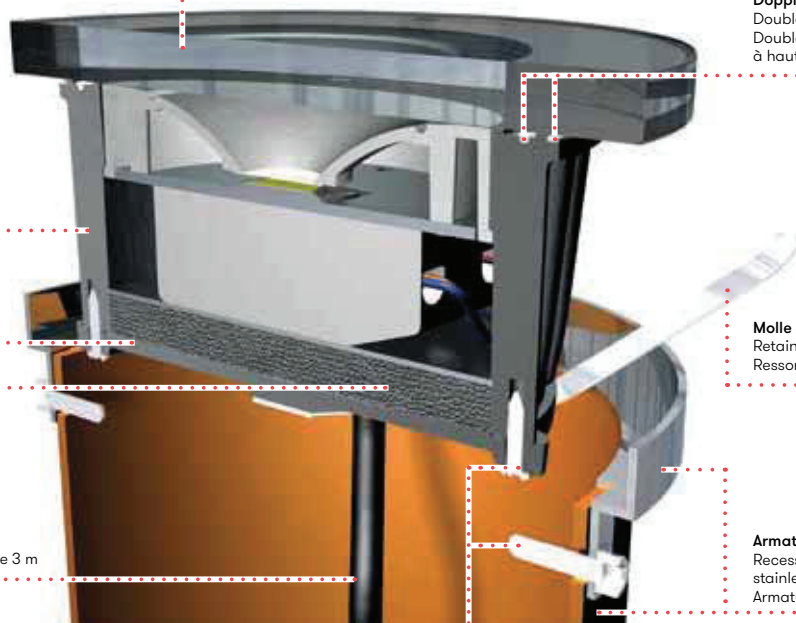

STILE NEXT ZERO 120T



STILE NEXT 260

Installazione

Installation
Installation

Incasso parete

Wall recess
Encastrement au mur

Materiali

Materials
Materiels

Materiale Corpo: Alluminio | Tipo di diffusore: Vetro serigrafato

Material: Aluminium | Diffuser type: Serigraphed glass
Matériel du corps: Aluminium | Type de diffuseur: Verre sérigraphié

Alimentazione

Power supply
Alimentation

220-240 V - Lampadina E27 (non inclusa)

220-240 V - E27 light bulb (not included)
220-240 V - Ampoule E27 (pas inclus)



STILE NEXT 260



COLOURS



Neutro
Neutral
Neutre

Stile next 260

IP66 IK 06 1J xx3 CE UK ER	LED				
	W	LM	REAL LM	COL.	CODE *
	10	1300	386	☉ ☉ 220-240 V	LL785E□
	LAMP				
	ATT. MAX	CFL			
	E27	1x20	☉	LB7852N	

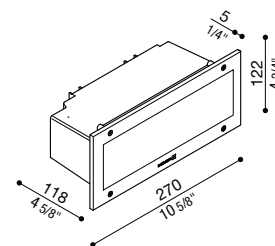

* Complete the CODE □ LED COLOUR N | 4000K 3 | 3000K

Lampade dim. max: E27 145 mm Ø 48 mm. | Lamp dim. max: E27 145 mm Ø 48 mm. | Lampes dim. max: E27 145 mm Ø 48 mm.

Accessori | Accessories | Accessoires

Armatura da incasso Stile 260 - Stile Next 260

Armatura da incasso in termoplastico.

Thermoplastic recess box Stile 260 - Stile Next 260
Thermoplastic recess box.

Armature à encastrer Stile 260 / Stile Next 260
Armature à encastrer en matériau thermoplastique.

Col.	Code
-	LB11530

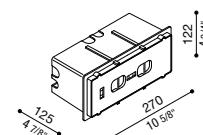

Cassaforma Polistirolo Stile 260 - Stile Next 260

Cassaforma in polistirolo.

Polystyrene mould Stile 260 - Stile Next 260
Polystyrene mould.

Gabarit en polystyrène Stile 260 / Stile Next 260
Gabarit en polystyrène.

Col.	Code
-	LB11550

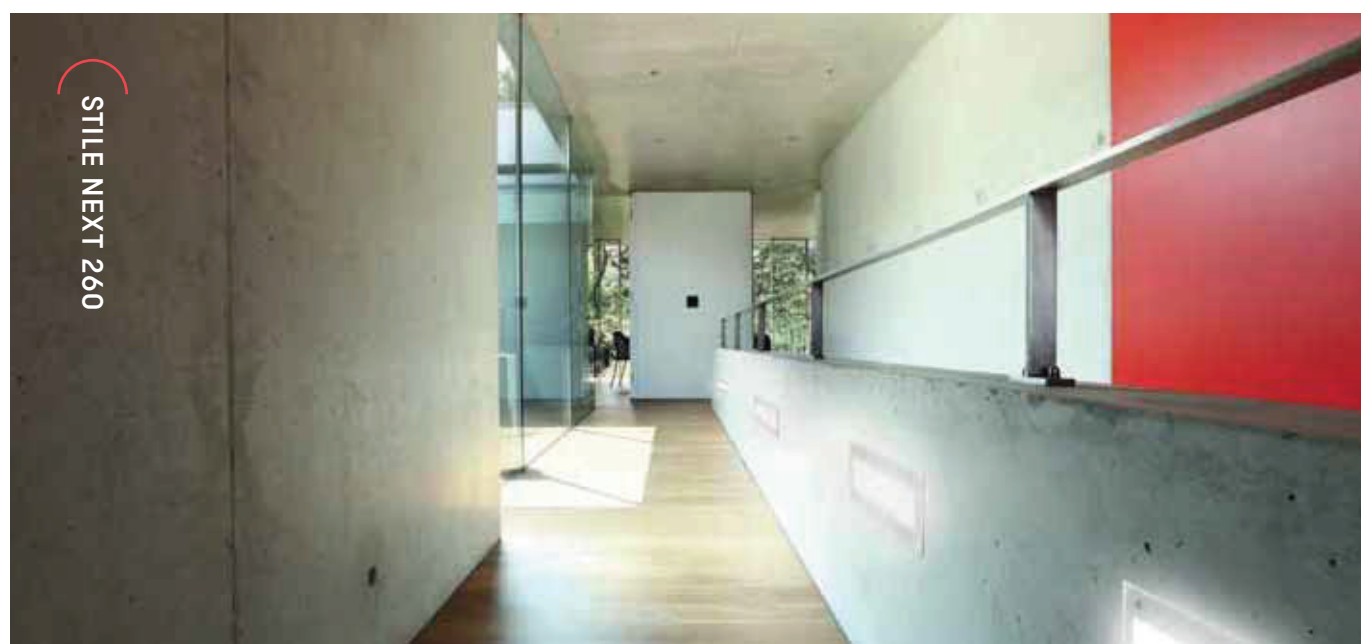
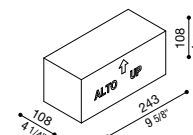

STILE NEXT 260

KIT STILE NEXT POST

Installazione
Installation
Installation

Terra
Ground
Sol

Materiali
Materials
Materiels

Materiale Corpo: Alluminio | Tipo di diffusore: Vetro serigrafato
Material: Aluminium | Diffuser type: Serigraphed glass
Matériel du corps: Aluminium | Type de diffuseur: Verre sérigraphié

Alimentazione
Power supply
Alimentation

220-240 V



KIT-01
STILE NEXT POST

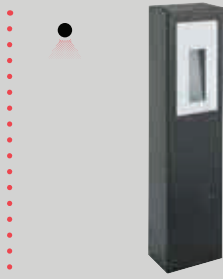

KIT-02
STILE NEXT POST



KIT-03
STILE NEXT POST



KIT-04
STILE NEXT POST



KIT-05
STILE NEXT POST



KIT-06
STILE NEXT POST



KIT-07
STILE NEXT POST



KIT-08
STILE NEXT POST



KIT-09
STILE NEXT POST



KIT-10
STILE NEXT POST



KIT-11
STILE NEXT POST



KIT-12
STILE NEXT POST



COLOURS



Grigio High Tech RAL 9006
Grey High Tech RAL 9006
Gris High Tech RAL 9006



Nero da stampaggio
Black
Noir moulé



Cemento grigio
Concrete, grey
Ciment, gris



Grigio antracite RAL 7021
Grey anthracite RAL 7021
Gris anthracite RAL 7021



Corten
Corten
Corten

Kit-01 Stile Next Post

IP66 IK 06 1J xx3 CE UK ER	LED			COL.	CODE *	
	W	LM	REAL LM			
	6	720	283		LL661001□ LL661005□ LL661009□	
				220-240 V		

* Complete the CODE LED COLOUR N | 4000K 3 | 3000K

Kit composto dagli attuali codici LB11652/G/K + LL661DN/3. | Kit consisting of the current codes LB11652/G/K + LL661DN/3. | Kit composé des codes actuels LB11652/G/K + LL661DN/3.

Kit-02 Stile Next Post

IP66 IK 06 1J xx3 CE UK ER	LED			COL.	CODE *	
	W	LM	REAL LM			
	3	310	38		LL661002□ LL661006□ LL661010□	
				220-240 V		

* Complete the CODE LED COLOUR N | 4000K 3 | 3000K

Kit composto dagli attuali codici LB11652/G/K + LL663CN/3. | Kit consisting of the current codes LB11652/G/K + LL663CN/3. | Kit composé des codes actuels LB11652/G/K + LL663CN/3.

Kit-03 Stile Next Post

IP66 IK 06 1J xx3 CE UK ER	LED			COL.	CODE *	
	W	LM	REAL LM			
	6+3		283 + 68		LL661003□ LL661007□ LL661011□	
				220-240 V 		

* Complete the CODE LED COLOUR N | 4000K 3 | 3000K

Kit composto dagli attuali codici LB11652/G/K + LL661DN/3 + LL641CN/3. | Kit consisting of the current codes LB11652/G/K + LL661DN/3 + LL641CN/3. | Kit composé des codes actuels LB11652/G/K + LL661DN/3 + LL641CN/3.

Kit-04 Stile next Post

IP66 IK 06 1J xx3 CE UK ER	LED			COL.	CODE *
	W	LM	REAL LM		
	3+3	38 + 68	220-240 V		LL661004□
					LL661008□
					LL661012□

* Complete the CODE □ LED COLOUR N | 4000K 3 | 3000K

Kit composto dagli attuali codici LB11652/G/K + LL663CN/3 + LL641CN/3. | Kit consisting of the current codes LB11652/G/K + LL663CN/3 + LL641CN/3. | Kit composé des codes actuels LB11652/G/K + LL663CN/3 + LL641CN/3.

Kit-05 Stile Next Post

IP66 IK 06 1J xx3 CE UK ER	LED			COL.	CODE *	
	W	LM	REAL LM			
	3	310	68	220-240 V		LL110000□
						LL110012□
						LL110006□
	6	720	170	220-240 V		LL110018□
						LL110019□
						LL110020□

* Complete the CODE □ LED COLOUR N | 4000K 3 | 3000K

Kit composto dagli attuali codici LB1100000/1/2 + LL641CN/3.
 BORDO MARE: aggiungi S alla fine del codice selezionato comprensivo di colore LED per avere il prodotto fornito con trattamento bordo mare contro le nebbie saline.
 Kit consisting of the current codes LB1100000/1/2 + LL641CN/3.
 BORDO MARE: add S to the end of the selected code including LED colour to have the product supplied with sea treatment against salt spray.
 Kit composé des codes actuels LB1100000/1/2 + LL641CN/3.
 BORDO MARE: ajoutez S à la fin du code sélectionné, y compris la couleur LED, pour que le produit soit fourni avec un traitement de bord de mer contre le brouillard salin.

Kit-06 Stile Next Post

IP66 IK 06 1J xx3 CE UK ER	LED			COL.	CODE *	
	W	LM	REAL LM			
	3	310	45	220-240 V		LL110001□
						LL110013□
						LL110007□

* Complete the CODE □ LED COLOUR N | 4000K 3 | 3000K

Kit composto dagli attuali codici LB1100000/1/2 + LL643CN/3.
 BORDO MARE: aggiungi S alla fine del codice selezionato comprensivo di colore LED per avere il prodotto fornito con trattamento bordo mare contro le nebbie saline.
 Kit consisting of the current codes LB1100000/1/2 + LL643CN/3.
 BORDO MARE: add S to the end of the selected code including LED colour to have the product supplied with sea treatment against salt spray.
 Kit composé des codes actuels LB1100000/1/2 + LL643CN/3.
 BORDO MARE: ajoutez S à la fin du code sélectionné, y compris la couleur LED, pour que le produit soit fourni avec un traitement de bord de mer contre le brouillard salin.

Kit-07 Stile Next Post

IP 66 IK 06 1J xx3 CE UK ER	LED		REAL LM	COL.	CODE *
	W	LM			
	3+3	68 + 68	⊕ ⊙ 220-240 V		LL110002□
					LL110014□
					LL110008□
	6+6	170+170	⊕ ⊙ 220-240 V		LL110021□
					LL110022□
					LL110023□

* Complete the CODE LED COLOUR N | 4000K 3 | 3000K

Kit composto dagli attuali codici LB1100003/4/5 + LL641CN/3 + LL641CN/3.
BORDO MARE: aggiungi S alla fine del codice selezionato comprensivo di colore LED per avere il prodotto fornito con trattamento bordo mare contro le nebbie saline.
 Kit consisting of the current codes LB1100003/4/5 + LL641CN/3 + LL641CN/3.
BORDO MARE: add S to the end of the selected code including LED colour to have the product supplied with sea treatment against salt spray.
 Kit composé des codes actuels LB1100003/4/5 + LL641CN/3 + LL641CN/3.
BORDO MARE: ajoutez S à la fin du code sélectionné, y compris la couleur LED, pour que le produit soit fourni avec un traitement de bord de mer contre le brouillard salin.

Kit-08 Stile Next Post

IP 66 IK 06 1J xx3 CE UK ER	LED		REAL LM	COL.	CODE *
	W	LM			
	3+3	45 + 45	⊕ ⊙ 220-240 V		LL110003□
					LL110015□
					LL110009□

* Complete the CODE LED COLOUR N | 4000K 3 | 3000K

Kit composto dagli attuali codici LB1100003/4/5 + LL643CN/3 + LL643CN/3.
BORDO MARE: aggiungi S alla fine del codice selezionato comprensivo di colore LED per avere il prodotto fornito con trattamento bordo mare contro le nebbie saline.
 Kit consisting of the current codes LB1100003/4/5 + LL643CN/3 + LL643CN/3.
BORDO MARE: add S to the end of the selected code including LED colour to have the product supplied with sea treatment against salt spray.
 Kit composé des codes actuels LB1100003/4/5 + LL643CN/3 + LL643CN/3.
BORDO MARE: ajoutez S à la fin du code sélectionné, y compris la couleur LED, pour que le produit soit fourni avec un traitement de bord de mer contre le brouillard salin.

Kit-09 Stile Next Post

IP 66 IK 06 1J xx3 CE UK ER	LED		REAL LM	COL.	CODE *
	W	LM			
	3+3	68 + 45	⊕ ⊙ 220-240 V		LL110004□
					LL110016□
					LL110010□

* Complete the CODE LED COLOUR N | 4000K 3 | 3000K

Kit composto dagli attuali codici LB1100003/4/5 + LL641CN/3 + LL643CN/3.
BORDO MARE: aggiungi S alla fine del codice selezionato comprensivo di colore LED per avere il prodotto fornito con trattamento bordo mare contro le nebbie saline.
 Kit consisting of the current codes LB1100003/4/5 + LL641CN/3 + LL643CN/3.
BORDO MARE: add S to the end of the selected code including LED colour to have the product supplied with sea treatment against salt spray.
 Kit composé des codes actuels LB1100003/4/5 + LL641CN/3 + LL643CN/3.
BORDO MARE: ajoutez S à la fin du code sélectionné, y compris la couleur LED, pour que le produit soit fourni avec un traitement de bord de mer contre le brouillard salin.

Kit-10 Stile Next Post

IP66 IK 06 1J xx3 	LED			COL.	CODE *	
	W	LM	REAL LM			
	3+3		45 + 68		LL110005 □ LL110017 □ LL110011 □	
			220-240 V			

* Complete the CODE LED COLOUR **N** | 4000K **3** | 3000K

Kit composto dagli attuali codici **LB1100003/4/5 + LL643CN/3 + LL641CN/3**.

BORDO MARE: aggiungi **S** alla fine del codice selezionato comprensivo di colore LED per avere il prodotto fornito con trattamento bordo mare contro le nebbie saline.

Kit consisting of the current codes **LB1100003/4/5 + LL643CN/3 + LL641CN/3**.

BORDO MARE: add **S** to the end of the selected code including LED colour to have the product supplied with sea treatment against salt spray.

Kit composé des codes actuels **LB1100003/4/5 + LL643CN/3 + LL641CN/3**.

BORDO MARE: ajoutez **S** à la fin du code sélectionné, y compris la couleur LED, pour que le produit soit fourni avec un traitement de bord de mer contre le brouillard marin.

Kit-11 Stile Next Post

IP66 IK 06 1J xx3 	LED			COL.	CODE *	
	W	LM	REAL LM			
	3	310	68		LL642C854 □	
			220-240 V			

* Complete the CODE LED COLOUR **N** | 4000K **3** | 3000K

Kit composto dagli attuali codici **LB11854 + LL642CN/3**. | Kit consisting of the current codes **LB11854 + LL642CN/3**. | Kit composé des codes actuels **LB11854 + LL642CN/3**.

Kit-12 Stile Next Post

IP66 IK 06 1J xx3 	LED			COL.	CODE *	
	W	LM	REAL LM			
	3	310	45		LL644C854 □	
			220-240 V			

* Complete the CODE LED COLOUR **N** | 4000K **3** | 3000K

Kit composto dagli attuali codici **LB11854 + LL644CN/3**. | Kit consisting of the current codes **LB11854 + LL644CN/3**. | Kit composé des codes actuels **LB11854 + LL644CN/3**.

Accessori | Accessories | Accessoires

Dima e kit di fissaggio Palo Stile Next

Dima, tirafondi e minuteria per ancoraggio del palo al terreno.

Template and fixing kit for post Stile Next

Template, fixing bolts and small metal parts to secure the post to the ground.

Gabarit, tire-fond et visserie pour ancrage du poteau Stile Next

Gabarit, tire-fond et visserie pour ancrage du poteau au sol.

Col.	Code
-	LB11255

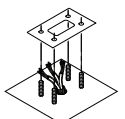



KIT STILE NEXT POST



KIT STILE NEXT POST